

# Ceramic Capacitors

## Standard & Custom Parts

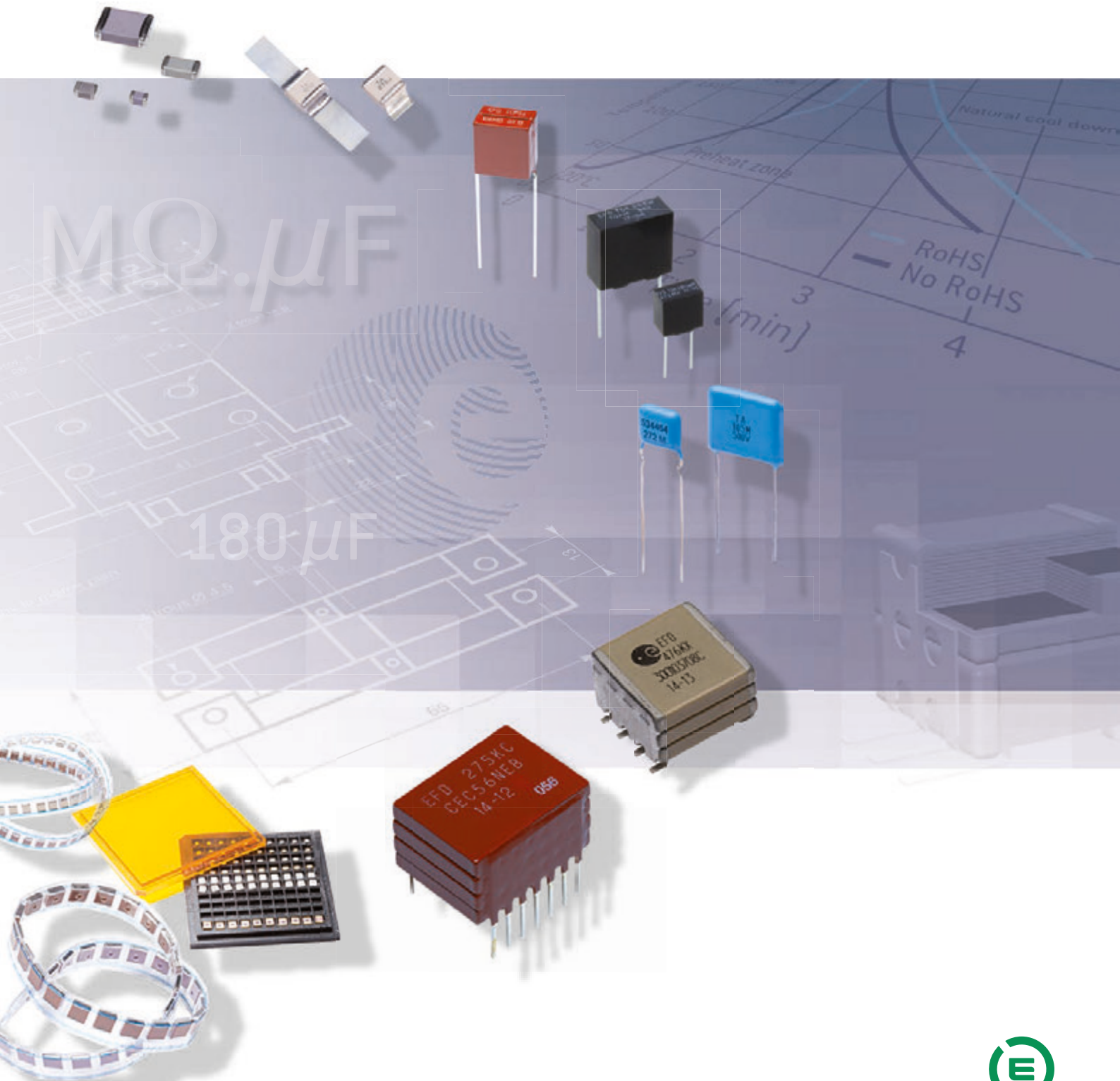



# Ceramic Capacitors



A Worldwide presence



Specifications are subject to change without notice. All statements, information and data given herein are presented without guarantee, warranty or responsibility of any kind, expressed or implied.

# General Information

## MATERIALS EXPERT

For 50 years and as a market leader, EXXELIA's comprehensive knowledge of the materials properties and performances have enabled us to design capacitors in Porcelain, NPO, BX, 2C1, BP, X7R and -2200ppm/°C ceramics.

## CUSTOM DESIGNS

Our catalog products don't meet your application?

Based on the valuable experience accumulated over the design of 2,000+ specific ceramic capacitors, you can trust EXXELIA to define a qualitative custom solution in a time effective manner.

## NO OBSOLESCENCE

Choosing a standard or custom Exxelia product means you won't have to worry about obsolescence.

## TYPICAL APPLICATIONS

- Aerospace & Defense: cockpit panels, flight control, radio systems, missile guidance systems...
- Space: military and commercial satellites, launcher...
- Medical: MRI, external defibrillators, implantable devices...
- Telecommunications: base stations...
- Oil and gas: drilling tools, MWD, LWD, wellheads...

## ISO 9001 AND AS9100C

Quality is at the core of Exxelia's corporate culture. Each sites has its own certifications.

## CERTIFICATIONS

Capacitors manufactured by EXXELIA comply with American and European standards and meet the requirements of many international standards.

For Space qualified parts (ESA QPL), please refer to our catalog «Ceramic capacitors for Space applications».

## QUALITY & RELIABILITY

EXXELIA is committed to design and manufacture high quality and reliability products. The test cycles reproducing the most adverse operating conditions over extended periods (up to 10 000 hours) have logged to date well over 5.109 hours/Component.

Failure rate data can be provided upon request.

## CONFLICT MINERALS

EXXELIA is committed to an approach based on «Conflict Minerals Compliance». This US SEC rule demands complete traceability and a control mechanism for the mineral procurement chain, encouraging importers to buy only «certified» ore.

We have discontinued relations with suppliers that procure from the Democratic Republic of the Congo or an adjoining country.

## ENVIRONMENT

EXXELIA is committed to applying a robust environmental policy, from product design through to shipment. To control its environmental footprint and reconcile this with the company' functional imperatives, our environmental policy provides for the reduction or elimination of hazardous substances. We also focus on compliance with European Union directives and regulations, notably REACH and RoHS.

## RoHS COMPLIANCY

### SMD CAPACITORS

The capacitor terminations are generally protected by a nickel barrier formed by electrolytic deposit. This barrier gives chip capacitors leaching performance far exceeding the requirements of all applicable standards. The nickel barrier guarantees a minimum resistance to soldering heat for a period of 1 minute at 260°C in a tin-lead (60/40) or tin-lead-silver (62/36/2) bath without noticeable alteration to the solderability. It also allows repeated soldering-unsoldering and the longer soldering times required by reflow techniques.

However nickel barrier amplifies thermal shock and is not recommended for chip sizes equal or greater than CNC Y (30 30) - (C 282 to C 288 - CNC 80 to CNC 94).

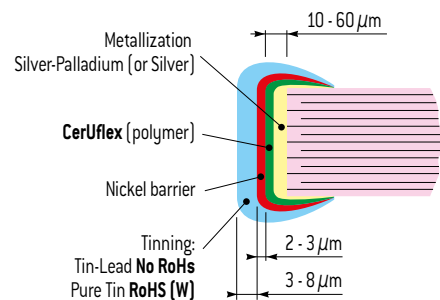















### LEADED COMPONENTS

As well as for SMD products, leaded capacitors ranges can also be RoHS. These products, which are characterized by the suffix «W» added to the commercial type, are naturally compatible with the soldering alloys used in RoHS mounting technology. The connections coating is generally an alloy SnAg (with a maximum of 4% Ag). However, on a few products that Exxelia will precise on request, the coating is pure silver.







# Selection Guide

Main Characteristic	Model	Size	Dielectric	Voltage	Capacitance	Temperature	Coating					Leads				Mounting		Main Applications	Page
							Uncoated	Varnished	Conformal coated	Molded	Self-protected	DIL	Ribbon	Axial	Radial	SMD	Through hole		
STANDARD	<b>CEC / CNC SERIES</b> Low and Medium Voltage Chips Capacitors	0402 to 3040	NPO BX to 2C1 X7R	10V to 1,000V	1pF to 12μF	-55°C to +125°C	•											Precision, stability, decoupling	22
	<b>NON MAGNETIC CHIPS SERIES</b> Low and Medium Voltage Chips Capacitors	0603 to 2220	NPO X7R	63V to 500V	10pF to 1μF	-55°C to +125°C	•											Precision, stability, decoupling	26
	<b>OP SERIES</b> Open Mode Chips Capacitors	0805 to 2220	NPO X7R	10V to 100V	1pF to 4.7μF	-55°C to +125°C	•											Precision, stability, decoupling, Significantly reduce risk of short circuit	28
	<b>CER / CNR SERIES</b> Low Inductance Chips Capacitors	0306 to 0612	NPO X7R	16V to 100V	1pF to 270nF	-55°C to +125°C	•											Decoupling, low ESL, medical embedded	30
	<b>C3N / C4N / C3E / C4E SERIES</b> Capacitors Arrays	-	NPO X7R	25V to 200V	4.7pF to 33nF	-55°C to +125°C	•											Medical embedded, miniaturisation	32
	<b>30 S4 SERIES</b> Safety Capacitors	-	NPO X7R	40V to 100V	470pF to 820nF	-55°C to +125°C	•				•				•			Railway	33
	<b>TCE / TCX / TCN / TXR MOLDED SERIES</b> Radial Molded Capacitors	-	NPO BX to 2C1 X7R	25V to 500V	1pF to 4.7μF	-55°C to +125°C			•						•			Precision, stability, decoupling	34
	<b>LA SERIES</b> Radial Molded Capacitors	-	NPO Temp. coeff.	25V to 63V	1pF to 680nF	-55°C to +125°C				•						•		Decoupling	36
	<b>TCE / TCX / TCN / TXR AXIAL SERIES</b> Axial Molded Capacitors	-	NPO BX - 2C1 X7R	25V to 500V	1pF to 3.9μF	-55°C to +125°C				•							•	Precision, stability, decoupling	38
	<b>TCE / TCX / TCN / TXR CONFORMAL COATED SERIES</b> Radial Dipped Capacitors	-	NPO BX - 2C1 X7R	25V to 500V	1pF to 6.8μF	-55°C to +125°C			•								•	Precision, stability, decoupling	40
	<b>NON MAGNETIC CONFORMAL COATED SERIES</b> Radial Dipped Capacitors	-	NPO X7R	63V to 500V	180pF to 1μF	-55°C to +125°C			•								•	Precision, stability, decoupling	42
	<b>CK SERIES</b> Radial Molded Capacitors	-	BX	25V to 250V	10pF to 1μF	-55°C to +125°C				•							•	Decoupling	44
HIGH VOLTAGE	<b>C Series</b> High voltage chips Capacitors	1812 to 16080	NPO C4xx X7R	200V to 10kV	10pF to 39μF	-55°C to +125°C	•												51
	<b>TCL / TCK Series</b> High voltage Molded & Varnished leaded Capacitors	-	NPO C4xx X7R	200V to 10kV	10pF to 39μF	-55°C to +125°C		•		•							•		54
	<b>TCF Series</b> High voltage Conformal coated leaded Capacitors	-	NPO C4xx X7R	200V to 10kV	10pF to 39μF	-55°C to +125°C			•								•		57
	<b>TKD Series</b> High voltage Conformal coated leaded Capacitors	-	NPO C4xx X7R	200V to 10kV	10pF to 39μF	-55°C to +125°C			•								•		60
	<b>CS Series</b> High voltage Stacked Capacitors	2220 to 16080	NPO C4xx X7R	1kV to 10kV	220pF to 15μF	-55°C to +125°C	•	•			•	•					•	•	62
	<b>VM Series</b> Voltage Multipliers	-	-	-	-	-	-55°C to +125°C				•							•	65
																		Power supply, voltage multiplier, radars. • aerospace • space • defence • railways	















# Selection Guide

Main Characteristic	Model	Size range	Dielectric	Voltage range	Capacitance range	Temperature range	Coating					Leads				Mounting		Main Applications	Page
							Uncoated	Varnished	Conformal coated	Molded	Self protected	DIL	Ribbon	Axial	Radial	SMD	Through hole		
HIGH CAPACITANCE	<b>R SERIES (CHIPS)</b> High Capacitance Chips Capacitors 	2225 to 45107	X7R	50V to 500V	47nF to 27µF	-55°C to +125°C	•									•		73	
	<b>R SERIES (LEADED)</b> Radial Leaded Conformal Coated Capacitors 	-	X7R	50V to 500V	47nF to 27µF	-55°C to +125°C			•							•		77	
	<b>TEF SERIES</b> Radial Leaded Conformal Coated Capacitors 	-	NPO	63V to 500V	10nF to 680nF	-55°C to +125°C			•							•		80	
	<b>SV / SC SERIES</b> High Capacitance Stacked Capacitors 	2225 to 125205	X7R	50V to 500V	47nF to 390µF	-55°C to +125°C	•	•				•	•			•	•	81	
	<b>CNC3X SERIES</b> High Capacitance Stacked Capacitors 	2220 to 4040	X7R	16V to 25V	1.2µF to 68µF	-55°C to +125°C	•	•				•				•	•	88	
	<b>CEC5X SERIES</b> High Capacitance Stacked Capacitors 	3033 to 80150	NPO	63V to 500V	10nF to 6.8µF	-55°C to +125°C	•	•				•				•	•	90	
	<b>TEP / TEV SERIES</b> High Capacitance Stacked Capacitors 	-	NPO	63V to 500V	10nF to 6.8µF	-55°C to +125°C		•								•	•	93	
<b>TCN8X SERIES</b> High Capacitance Molded Stacked Capacitors 	-	X7R	63V to 500V	0.47µF to 120µF	-55°C to +125°C				•						•	•	95		
HIGH TEMPERATURE	<b>CE / CN SERIES</b> High Temperature Chips Capacitors 	0402 to 3040	NPO to X7R	16V to 100V	1pF to 8.2µF	-55°C to +250°C	•									•		100	
	<b>SCT SERIES</b> High Temperature Stacked Capacitors 	2225 to 125205	X7R	50V to 500V	47nF to 390µF	-55°C to +215°C	•	•				•				•	•	102	
	<b>TCE / TCN MOLDED SERIES HT</b> High Temperature Molded Capacitors 	-	NPO to X7R	16V to 100V	1pF to 10µF	-55°C to +220°C				•						•	•	107	
	<b>TCE / TCN SELF-PROTECTED SERIES</b> High Temperature Self-Protected Capacitors 	-	NPO to X7R	25V to 500V	10pF to 3.9µF	-55°C to +250°C							•			•	•	109	
	<b>TCH SERIES</b> High Temperature High Voltage Capacitors 	-	NPO to X7R	200V to 10kV	10pF to 15µF	-55°C to +250°C		•								•	•	111	
FEED-THRU	<b>TBC SERIES</b> Discoidal Capacitors 	-	NPO to X7R	25V to 1kV	10pF to 12µF	-55°C to +125°C	•									•	Very low ESL	115	
	<b>BPM SERIES</b> Planar Array 	-	X7R	25V to 200V	330pF to 68nF	-55°C to +125°C	•									•	Very low ESL, miniaturisation	117	

# Selection Guide

Main Characteristic	Model	Size range	Dielectric	Voltage range	Capacitance range	Temperature range	Coating					Leads				Mounting		Main Applications	Page
							Uncoated	Varnished	Conformal coated	Molded	Self protected	DIL	Ribbon	Axial	Radial	SMD	Through hole		
HIGH Q	<b>CH SERIES</b> Classic HiQ 	0505 1111	P100	50V to 1.5kV	0.1pF to 1nF	-55°C to +175°C	•						•	•	•	•	Cellular base station amplifier, MRI.	129	
	<b>SH SERIES</b> Super HiQ 	0402 to 1210	NPO	25V to 1.5kV	0.2pF to 1nF	-55°C to +150°C	•						•	•	•	•	Cellular base station equipment Broadband Point to point/ multi-point radios RF generators	132	
	<b>SHD / SHR SERIES</b> Reverse Geometry 	0709 0711	NPO	500V	0.5pF to 100pF	-55°C to +175°C	•								•			135	
	<b>NHB SERIES</b> High Self Resonant Frequency 	1111	NPO	500V	0.3pF to 100pF	-55°C to +175°C	•								•		137		
	<b>CP SERIES</b> High Power 	2225 4040	P100	200V to 7kV	1pF to 10nF	-55°C to +125°C	•	•					•	•	•	•	RF power amplifier Plasma chamber MRI coils	139	
	<b>CL SERIES</b> High Power 	2225 to 7065	NPO	200V to 7kV	1pF to 10nF	-55°C to +125°C	•	•					•	•	•	•	RF power amplifier Plasma chamber MRI coils	143	

## ADDITIONAL AVAILABLE RANGES (consult our website)

STANDARD	<b>TCE1X Series</b> 	-	NPO	63V to 100V	0,5pF to 10nF	-55°C to +125°C		•					•	•		Precision, stability, decoupling	-
	<b>TCN19 Series</b> 	-	2C1	63V to 250V	10pF to 1µF	-55°C to +125°C		•					•	•		Decoupling	-
	<b>TCN3X Series</b> 	-	2C1	50V to 100V	100pF to 1,8µF	-55°C to +125°C		•					•	•			-
	<b>LAG Series</b> 	-	2C1	25V to 63V	100pF to 1µF	-55°C to +125°C		•					•	•			-
HIGH VOLTAGE	<b>H Series</b> 	0805 to 6560	NPO X7R	1kV to 10kV	2pF to 390nF	-55°C to +125°C	•	•					•	•	•	Power supply, voltage multiplier, radars.	-
HIGH CAPACITANCE	<b>CNC5X Series</b> 	3033 to 80150	X7R	63V to 500V	0,1µF to 180µF	-55°C to +125°C	•	•			•			•	•	Switch Mode Power Supply, filtering, decoupling, • aerospace • space • defence	-
	<b>CNC8X Series (chips)</b> 	3033 to 33110	X7R	63V to 400V	47nF to 27µF	-55°C to +125°C	•							•			-
	<b>CNC8X Series (DIL)</b> 	3333 to 80150	X7R	63V to 400V	47nF to 180µF	-55°C to +125°C	•	•			•			•	•		-
	<b>TCP / TCV8X Series</b> 	3333 to 80150	X7R	63V to 400V	47nF to 180µF	-55°C to +125°C	•	•						•	•		-
	<b>TCP / TCV5X Series</b> 	3033 to 80150	X7R	63V to 500V	0,1µF to 180µF	-55°C to +125°C	•	•						•	•		-
	<b>TCF Series</b> 	-	X7R	63V to 500V	0,1µF to 18µF	-55°C to +125°C		•						•	•		-
HIGH TEMP.	<b>CNC25X Series</b> 	3033 to 5550	X7R	50V	1µF to 33µF	-55°C to +200°C	•	•			•			•	•	Oil drilling, motor control, braking systems.	-
HIGH Q	<b>CNW Series</b> 	-	X7R	100V to 300V	10nF to 1µF	-55°C to +125°C	•						•	•	•	Power amplifier	-
	<b>SPT519 / CAW CEW Series</b> 	-	NPO	100V to 300V	10nF to 1µF	-55°C to +125°C	•	•					•	•	•		-

# Ceramic Capacitors Technology

## MLCC STRUCTURE

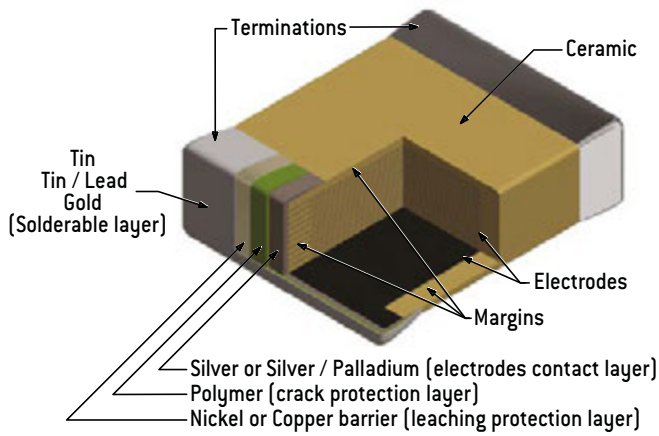

## DIELECTRIC CHARACTERISTICS

**Insulation Resistance (IR)** is the resistance measured under DC voltage across the terminals of the capacitor and consists principally of the parallel resistance shown in the equivalent circuit. As capacitance values and hence the area of dielectric increases, the IR decreases and hence the product (C x IR) is often specified in  $\Omega \cdot F$  or  $M\Omega \cdot \mu F$ .

**The Equivalent Series Resistance (ESR)** is the sum of the resistive terms which generate heating when capacitor is used under AC voltage at a given frequency (f).

**Dissipation factor (DF)** is the ration of the apparent power input will turn to heat in the capacitor:

$$DF = 2\pi f C ESR$$

When a capacitor works under AC voltage, **heat power loss (P)**, expressed in Watt, is equal to:

$$P = 2\pi f C V_{rms}^2 DF$$

## EQUIVALENT CIRCUIT

Capacitor is a complex component combining resistive, inductive and capacitive phenomena. A simplified schematic for the equivalent circuit is:

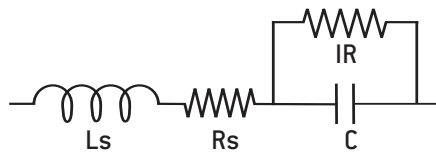

**The series inductance (Ls)** is due to the currents running through the electrodes. It can distort the operation of the capacitor at high frequency where the **impedance (Z)** is given as:

$$Z = R_s + j (L_s \cdot \omega - 1 / (C \cdot \omega)) \text{ with } \omega = 2\pi f$$

When frequency rises, the capacitive component of capacitors is gradually canceled up to the resonance frequency, where :

$$Z = R_s \text{ and } L_s C \cdot \omega^2 = 1$$

Above this frequency the capacitor behaves like an inductor.

	P100	NPO	N2200 (C4xx)	BX	2C1	X7R
<b>Dielectric material</b>	Porcelain	Magnesium titanate or Neodymium baryum titanate	Barium zirconate titanate	Baryum titanate (BaTiO <sub>3</sub> )		
<b>Dielectric constant</b>	15 – 18	20 – 85	450	2,000 – 5,000		
<b>Electrode technology</b>	PME (Precious Metal Electrodes): Ag/Pd					
<b>Capacitance variation between —55°C and +125/° C without DC voltage</b>	[100 ± 30]ppm/° C	[0 ± 30]ppm/° C	[–2,200 ± 500] ppm/° C	± 15%	± 20%	± 15%
<b>Capacitance variation between —55°C and +125/° C with DC rated voltage</b>			0 -15%	15% –25%	20% –30%	Not applicable
<b>Piezo-electric effect</b>	None		None	Yes		
<b>Dielectric absorption</b>	None		Few %	Few %		
<b>Thermal shock sensitive</b>	+		+	++		



# Ceramic Capacitors Technology

## MANUFACTURING STEPS

SLIP CASTING



A slurry, a mix of ceramic powder, binder and solvents, is poured onto conveyor belt inside a drying oven, resulting in a dry ceramic sheet.

ELECTRODE SCREEN PRINTING

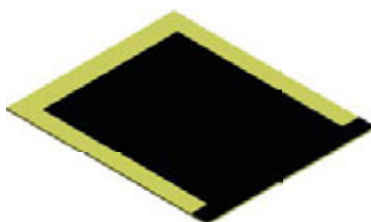

The electrode ink, made from a metal powder mixed with solvents, is printed onto the ceramic sheets using a screen printing process.

STACKING

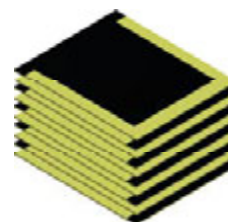

The sheets with electrode printed are stacked to create a multilayer structure.

PRESSING

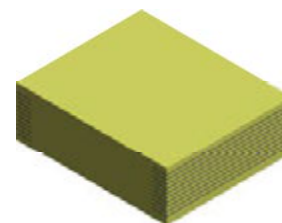

Pressure is applied to the stack to fuse all the separate layers, this created a monolithic structure.

SINTERING

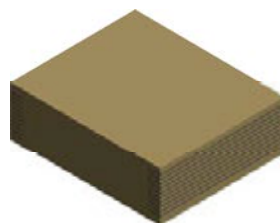

The parts are sintered in an oven with a precise temperature profile which is very important to the characteristics of the capacitors.

TERMINATIONS

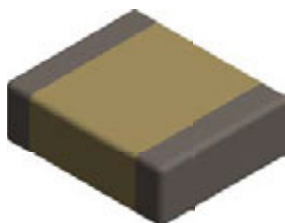

Each terminal of the capacitor is dipped in the termination ink, mix of metal powder, solvents and glass frit and the parts are fired in an oven.

TERMINATIONS PLATING

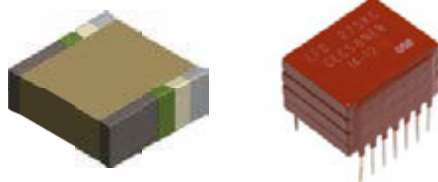

Stacking + leads soldering + encapsulation  
[see pages 10-11]

FINAL TESTING

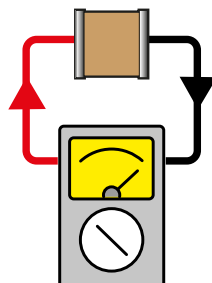

PACKAGING



# User Guide

## SMD TERMINATIONS

NON RoHS COMPLIANT	Code	RoHS COMPLIANT	Code	Recommended mounting process							Storage [months]*	
				Magnetic	Epoxy bonding	Iron soldering	Wave soldering	Vapor phase soldering	Infrared soldering	Wire bonding		
Ag	<b>Q</b>	Ag	<b>QW / P</b>	No	•	•	•	•				18
Ag/Pd/Pt	-	Ag/Pd/Pt	<b>W / A</b>	No	•	•	•					24
Ag + Ni + dipped Sn/Pb 60/40	<b>T**</b>	-	-	No		•	•	•	•			24
Ag/Pd/Pt + dipped Sn/Pb 60/40	<b>H</b>	Ag/Pd/Pt + dipped Sn	<b>HW</b>	No		•						24
Ag + Ni + electrolytic Sn/Pb 95/5	<b>C</b>	Ag + Ni + electrolytic Sn	<b>CW / S</b>	Yes		•	•	•	•			18
Ag + Ni + electrolytic Sn/Pb 60/40	<b>D</b>	-	-	Yes		•	•	•	•			18
-	-	Ag + Cu + electrolytic Sn	<b>C***</b>	No		•	•	•	•			18
Ag + Ni + dipped Sn/Pb 60/40	<b>E</b>	Ag + Ni + electrolytic Sn	<b>EW</b>	Yes		•	•					24
Ag + Ni + Au	<b>G</b>	Ag + Ni + Au	<b>GW</b>	Yes	•	•	•	•	•	•		36
Ag + Polymer + Ni + Sn/Pb 95/5	<b>YC</b>	Ag + Polymer + Ni + Sn	<b>YCW</b>	Yes		•	•	•	•			18
Ag + Polymer + Ni + Sn/Pb 60/40	<b>YD</b>	-	-	Yes		•	•	•	•			18
Ag + Polymer + Ni + Au	<b>YG</b>	Ag + Polymer + Ni + Au	<b>YGW</b>	Yes	•	•	•	•	•	•		36

Nickel (Ni) or Copper (Cu) barriers amplify thermal shock and are not recommended for chip sizes larger than 3030.

\* Storage must be in a dry environment at a temperature of 20° C with a relative humidity below 50%, or preferably in a package enclosing a desiccant.

\*\* Maintenance only.

\*\*\* Non magnetic chips series only.

## SMD ENVIRONMENTAL TESTS

Ceramic chip capacitors for SMD are designed to meet test requirements of **CECC 32100** and **NF C 93133** standards as specified below in compliance with NF C 20700 and IEC 68 standards:

- Solderability: **NF C 20758**, 260° C, bath 62/36/2.
- Adherence: 5N force.
- Vibration fatigue test: **NF C 20706**, 20 g, 10 Hz to 2,000 Hz, 12 cycles of 20 minutes each.
- Rapid temperature change: **NF C 20714**, –55°C to + 125° C, 5 cycles.
- Combined climatic test: **IEC 68-2-38**.
- Damp heat: **NF C 20703**, 93 %, H.R., 40° C.
- Endurance test: 1,000 hours, 1.5 U<sub>RC</sub>, 125° C.

## STORAGE OF CHIP CAPACITORS

### TINNED OR NON TINNED CHIP CAPACITORS

Storage must be in a dry environment at a temperature of 20°C with a relative humidity below 50 %, or preferably in a packaging enclosing a desiccant.

### STORAGE IN INDUSTRIAL ENVIRONMENT:

- 2 years for tin dipped chip capacitors,
- 18 months for tin electroplated chip capacitors,
- 2 years for non tinned chip capacitors,
- 3 years for gold plated chip capacitors.

### STORAGE IN CONTROLLED NEUTRAL NITROGEN ENVIRONMENT:

- 4 years for tin dipped or electroplated chip capacitors,
- 4 years for non tinned chip capacitors,
- 5 years for gold plated chip capacitors.

Storage duration should be considered from delivery date and not from batch manufacture date. The tests carried out at final acceptance stage [solderability, susceptibility to solder heat] enable to assess the compatibility to surface mounting of the chips.

# User Guide

## LEAD STYLES

### SURFACE MOUNTING

#### DIL LEADS

P style



PL style



L style

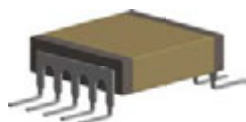

J style

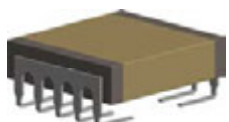

#### RIBBON LEADS

Micro-strip (type 1)  
Short Micro-strip (type 1S)

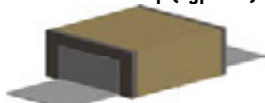

Axial (Type 2)

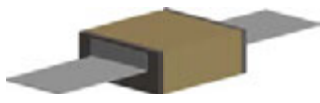

Radial (Type 3)



R style

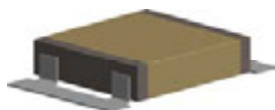

RX style

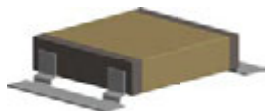

RJ style

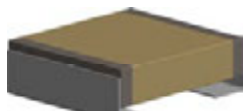

Please contact Exxelia sales for any lead configuration not shown.

### TROUGH-HOLE MOUNTING

#### AXIAL AND RADIAL

Radial leads (Type 6)



Radial leads (4 leads)

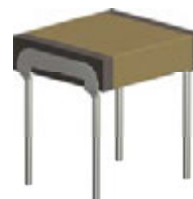

Axial leads (Type 7)



DIL leads: N style

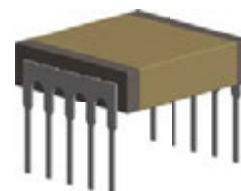

### ENCAPSULATION STYLES

Ceramic encapsulation  
(selfprotected)



Varnish

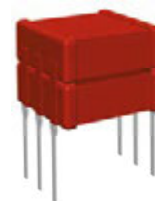

Conformal coating



Molding



# User Guide

## SOLDERING ADVICES FOR REFLOW SOLDERING

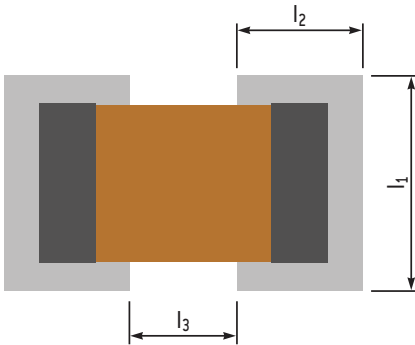

Large chips above size 2225 are not recommended to be mounted on epoxy board due to thermal expansion coefficient mismatch between ceramic capacitor and epoxy. Where larger sizes are required, it is recommended to use components with ribbon or other adapted leads so as to absorb thermo-mechanical strains.

Dimensions in inches (in mm)	Reflow soldering						Wave soldering					
	l <sub>1</sub>		l <sub>2</sub>		l <sub>3</sub>		l <sub>1</sub>		l <sub>2</sub>		l <sub>3</sub>	
0402	0.043	[1.1]	0.035	[0.9]	0.012	[0.3]	0.043	[1.1]	0.047	[1.2]	0.012	[0.3]
0403	0.055	[1.4]	0.035	[0.9]	0.012	[0.3]	0.055	[1.4]	0.047	[1.2]	0.012	[0.3]
0504	0.063	[1.6]	0.051	[1.3]	0.016	[0.4]	0.063	[1.6]	0.063	[1.6]	0.016	[0.4]
0603	0.055	[1.4]	0.059	[1.5]	0.02	[0.5]	0.055	[1.4]	0.071	[1.8]	0.02	[0.5]
0805	0.073	[1.85]	0.065	[1.65]	0.024	[0.6]	0.073	[1.85]	0.077	[1.95]	0.024	[0.6]
0907	0.094	[2.4]	0.065	[1.65]	0.035	[0.9]	0.094	[2.4]	0.077	[1.95]	0.035	[0.9]
1005	0.073	[1.85]	0.067	[1.7]	0.039	[1]	0.073	[1.85]	0.079	[2]	0.039	[1]
1206	0.083	[2.1]	0.067	[1.7]	0.059	[1.5]	0.083	[2.1]	0.079	[2]	0.059	[1.5]
1210	0.118	[3]	0.069	[1.75]	0.059	[1.5]	0.118	[3]	0.081	[2.05]	0.059	[1.5]
1605	0.073	[1.85]	0.071	[1.8]	0.087	[2.2]	0.073	[1.85]	0.083	[2.1]	0.087	[2.2]
1806	0.087	[2.2]	0.073	[1.85]	0.102	[2.6]	0.087	[2.2]	0.085	[2.15]	0.102	[2.6]
1812	0.152	[3.85]	0.073	[1.85]	0.102	[2.6]	0.152	[3.85]	0.085	[2.15]	0.102	[2.6]
1825	0.281	[7.15]	0.073	[1.85]	0.102	[2.6]	0.281	[7.15]	0.085	[2.15]	0.102	[2.6]
2210	0.13	[3.3]	0.079	[2]	0.146	[3.7]	0.13	[3.3]	0.091	[2.3]	0.146	[3.7]
2220	0.228	[5.8]	0.079	[2]	0.146	[3.7]	0.228	[5.8]	0.091	[2.3]	0.146	[3.7]
2225	0.281	[7.15]	0.079	[2]	0.146	[3.7]	0.281	[7.15]	0.091	[2.3]	0.146	[3.7]

### RECOMMENDED FOOTPRINT FOR SMD CAPACITORS

Ceramic is by nature a material which is sensitive both thermally and mechanically. Stresses caused by the physical and thermal properties of the capacitors, substrates and solders are attenuated by the leads.

Wave soldering is unsuitable for sizes larger than 2220 and for the higher ends of capacitance ranges due to possible thermal shock (capacitance values given upon request).

Infrared and vapor phase reflow, are preferred for high reliability applications as inherent thermo-mechanical strains are lower than those inherent to wave soldering.

Whatever the soldering process is, it is highly recommended to apply a thermal cycle, see hereafter our recommended soldering profile:

### RECOMMENDED VAPOR PHASE REFLOW PROFILE

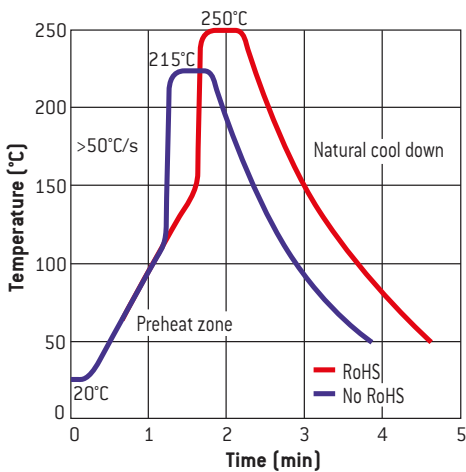

### RECOMMENDED IR REFLOW PROFILE

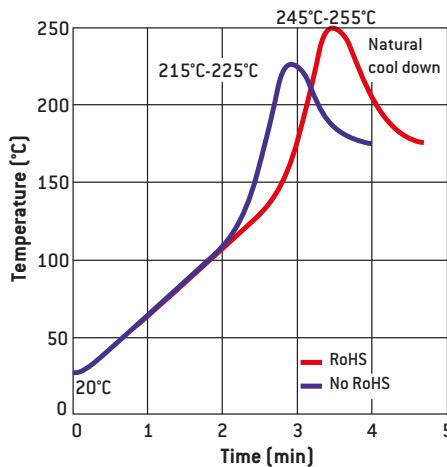

### RECOMMENDED WAVE SOLDERING PROFILE

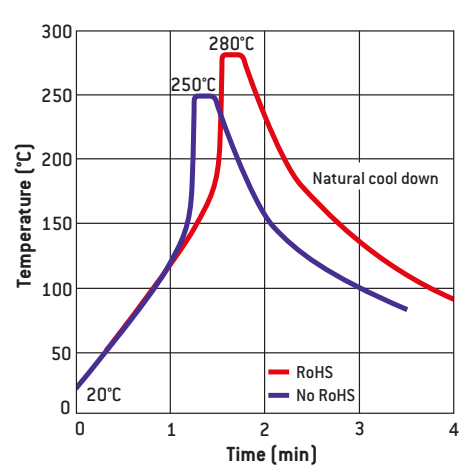

# User Guide

## SOLDERING ADVICES FOR IRON SOLDERING

Attachment with a soldering iron is discouraged due to ceramic brittleness and the process control limitations. In the event that a soldering iron must be used, the following precautions should be observed:

- Use a substrate with chip footprints big enough to allow putting side by side one end of the capacitor and the iron tip without any contact between this tip and the component,
- place the capacitor on this footprint,
- heat the substrate until the capacitor's temperature reaches 150° C minimum [preheating step, maximum 1° C per second],
- place the hot iron tip [a flat tip is preferred] on the footprint **without touching the capacitor**. Use a regulated iron with a 30 watts maximum power. The recommended temperature of the iron is 270 ± 10° C. The temperature gap between the capacitor and the iron tip must not exceed 120° C,

- leave the tip on the footprint for a few seconds in order to increase locally the footprint's temperature,
- use a cored wire solder and put it down on the iron tip. In a preferred way use Sn/Pb/Ag 62/36/2 alloy,
- wait until the solder fillet is formed on the capacitor's termination,
- take away iron and wire solder,
- wait a few minutes so that the substrate and capacitor come back down to the preheating temperature,
- solder the second termination using the same procedure as the first,
- let the soldered component cool down slowly to avoid any thermal shock.

## PACKAGING

### TAPE AND REEL

The films used on the reels correspond to standard IEC 60286-3. Films are delivered on reels in compliance with document IEC 286-3 dated 1991.

Minimum quantity is 250 chips.

Maximum quantities per reel are as follows:

- Super 8 reel - Ø 180: 2,500 chips.
- Super 8 reel - Ø 330: 10,000 chips.
- Super 12 reel - Ø 180: 1,000 chips.

Reel marking complies with CECC 32100 standard:

- Model.
- Rated capacitance.
- Capacitance tolerance.
- Rated voltage.
- Batch number.

### TRAY PACKAGES

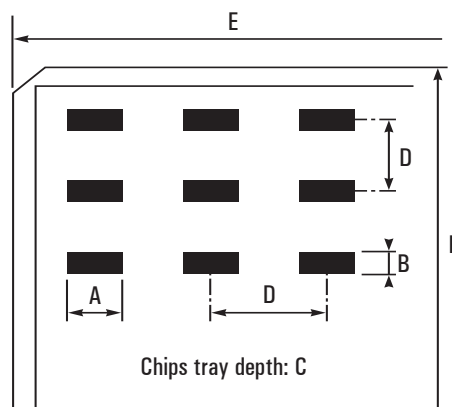

### DIMENSIONAL CHARACTERISTICS OF CHIPS TRAY PACKAGES

Sizes	Nr. of chips/ package	Oriented chips	Dimensions in inches (in mm)				
			A	B	C	D	E
0402	100	No	0 0.112 (0 3.02)		0.065 (1.65)	0.167 (4.24)	2 (50.8)
0403	100	No	0 0.112 (0 3.02)		0.065 (1.65)	0.167 (4.24)	2 (50.8)
0504	100	Yes	0.059 (1.5)	0.045 (1.14)	0.035 (0.89)	0.167 (4.24)	2 (50.8)
0603	340	Yes	0.1 (2.54)	0.06 (1.52)	0.045 (1.14)	0.167 (4.24)	2 (50.8)
0805	100	Yes	0.1 (2.54)	0.06 (1.52)	0.045 (1.14)	0.167 (4.24)	2 (50.8)
1206	100	No	0.14 (3.56)	0.14 (3.56)	0.06 (1.52)	0.167 (4.24)	2 (50.8)
1210	100	Yes	0.14 (3.56)	0.14 (3.56)	0.06 (1.52)	0.167 (4.24)	2 (50.8)
1812	100	No	0.25 (6.35)	0.25 (6.35)	0.13 (3.3)	0.345 (8.76)	4 (101.6)
	25	Yes	0.24 (6.1)	0.265 (6.73)	0.07 (1.78)	0.345 (8.76)	2 (50.8)
2220	100	Yes	0.25 (6.35)	0.25 (6.35)	0.13 (3.3)	0.345 (8.76)	4 (101.6)
	25	Yes	0.24 (6.1)	0.265 (6.73)	0.07 (1.78)	0.345 (8.76)	2 (50.8)

# User Guide

## EIA STANDARD CAPACITANCE VALUES

Following EIA standard, the values and multiples that are indicated in the chart below can be ordered. E48, E96 series and intermediary values are available upon request.

E6 (± 20%)	E12 (± 10%)	E24 (± 5%)
10	10	10
		11
		12
15	12	13
		15
		16
22	15	18
		20
		22
33	18	24
		27
		30
47	22	33
		36
		39
68	27	43
		47
		51
82	33	56
		62
		68
100	39	75
		82
		91

## EIA CAPACITANCE CODE

The capacitance is expressed in three digit codes and in units of pico Farads [pF]. The first and second digits are significant figures of the capacitance value and the third digit identifies the multiplier.

For capacitance value < 10pF, R designates a decimal point.  
See examples below:

EIA code	Capacitance value		
	in pF	in nF	in $\mu$ F
2R2	2.2	0.0022	0.0000022
6R8	6.8	0.0068	0.0000068
220	22	0.022	0.000022
470	47	0.047	0.000047
181	180	0.18	0.00018
221	220	0.22	0.00022
102	1,000	1	0.001
272	2,700	2.7	0.0027
123	12,000	12	0.012
683	68,000	68	0.068
124	120,000	120	0.12
564	560,000	560	0.56
335	3,300,000	3,300	3.3
825	8,200,000	8,200	8.2
156	15,000,000	15,000	15
686	68,000,000	68,000	68
107	100,000,000	100,000	100
227	220,000,000	220,000	220

## PART MARKING VOLTAGE CODES

Use the following voltage code chart for part markings:

Voltage (V)	Code	Letter code
25	250	A
40	400	B
50	500	C
63	630	D
100	101	E
200	201	G
250	251	H
400	401	K
500	501	L
1,000	102	M
2,000	202	P
3,000	302	R
4,000	402	S
5,000	502	T
7,500	752	U
10,000	103	W

## PART MARKING TOLERANCE CODES

Use the following tolerance code chart for part markings:

Tolerance	Letter code
± 0.25pF	CU
± 0.5pF	DU
± 1pF	FU
± 1%	F
± 2%	G
± 5%	J
± 10%	K
± 20%	M

# User Guide

## RELIABILITY LEVELS

Exxelia proposes different reliability levels for the ceramic capacitors for both NPO and X7R ceramics.

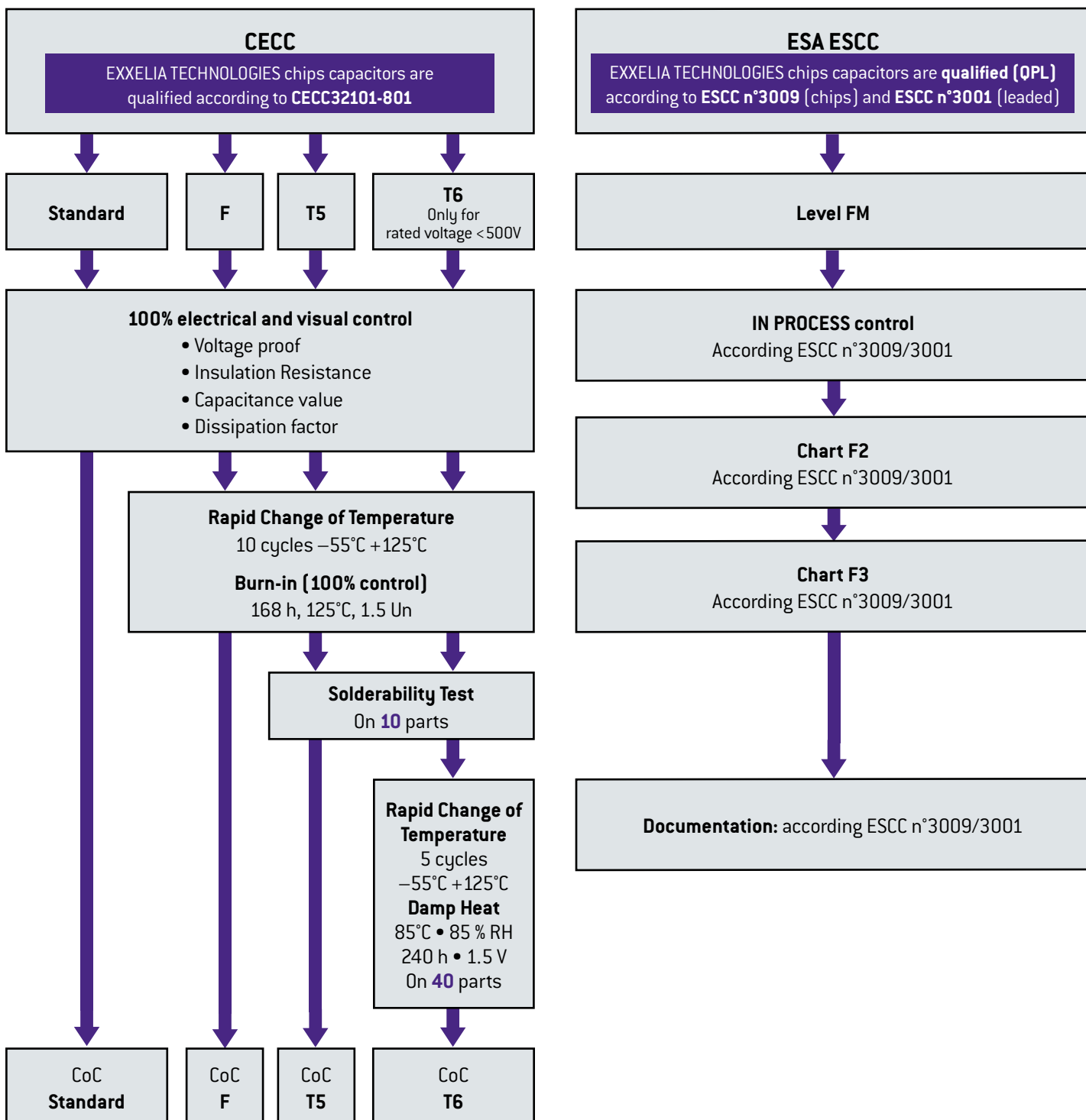

# Custom Design

As the world's leading manufacturer of specific passive components, we stand apart through our ability to quickly evaluate the application specific engineering challenges and provide a cost-effective and efficient solutions.

For requirements that cannot be met by catalog products, we offer leading edge solutions in custom configuration: custom geometries, packaging, characteristics, all is possible thanks to our extensive experience and robust development process, while maintaining the highest level of reliability.

Where necessary, special testing is done to verify requirements, such as low dielectric absorption, ultra-high insulation resistance, low dissipation factor, stability under temperature cycling or under specified environmental conditions, etc.

## HIGH CAPACITANCE

- High energy density
- Specific case sizes
- Specific shape of connections (high resistance to vibrations)

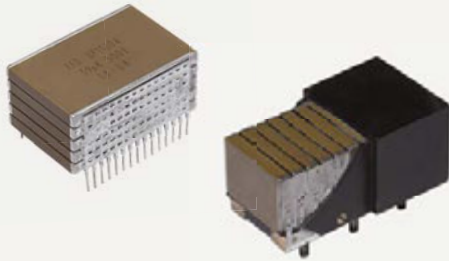

## HIGH VOLTAGE

- Up to 50 kV
- Specific circular shape

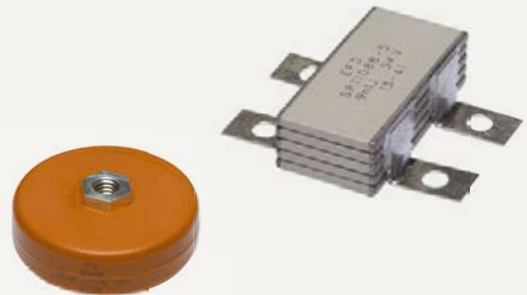

## HIGH TEMPERATURE

- Up to 250°C
- Specific shape of connections
- 2 000 hours life time
- HMP soldering

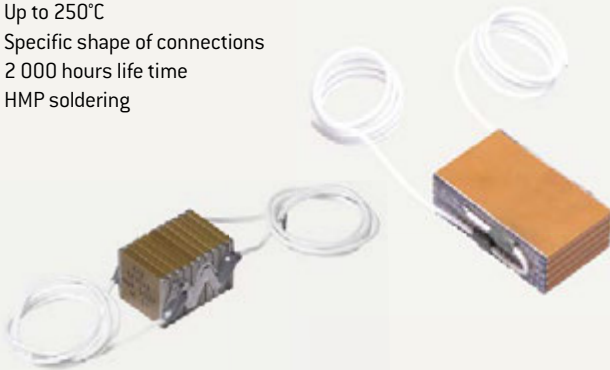

## OTHERS

- Screen printed resistors
- Complex components
- Full functions available

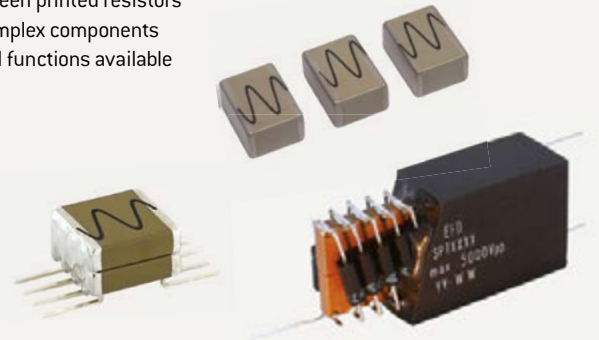



# STANDARD

GENERAL INFORMATION NPO/COG ..... 18

GENERAL INFORMATION X7R ..... 20

## CEC / CNC SERIES

Low and Medium Voltage Chips Capacitors ..... 22

## NON MAGNETIC CHIPS SERIES

Low and Medium Voltage Chips Capacitors ..... 26

## OP SERIES

Open Mode Chips Capacitors ..... 28

## CER / CNR SERIES

Low inductance Chips Capacitors ..... 30

## C3N / C4N / C3E / C4E SERIES

Capacitors Arrays ..... 32

## 30 S4 SERIES

Safety Capacitors ..... 33

## TCE / TCX / TCN / TXR MOLDED SERIES

Radial Molded Capacitors ..... 34

## LA SERIES

Radial Molded Capacitors ..... 36

## TCE / TCX / TCN / TXR AXIAL SERIES

Axial Molded Capacitors ..... 38

## TCE / TCX / TCN / TXR CONFORMAL COATED SERIES

Radial Dipped Capacitors ..... 40

## NON MAGNETIC CONFORMAL COATED SERIES

Radial Dipped Capacitors ..... 42

## CK SERIES

Radial Molded Capacitors ..... 44

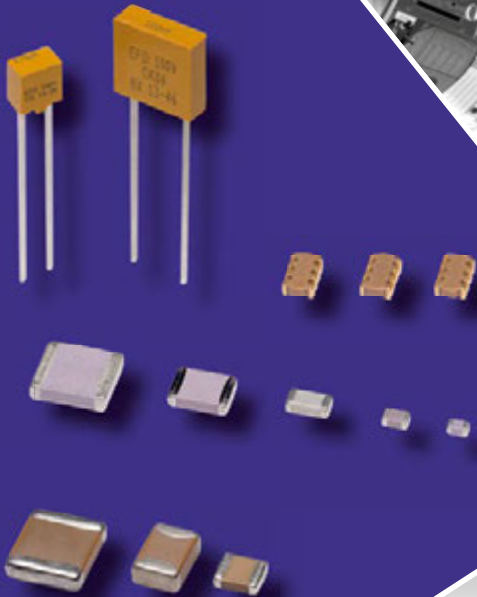

# General Information NPO/COG (Class 1)

## COMPOSITION

NPO capacitors are produced by using a dielectric made of titanium dioxide ( $TiO_2$ ) modified by magnesium oxide  $MgO$  (white ceramics) or a rare earth oxide, e.g.  $Nd_2O_3$  (other NPO ceramics).

As a consequence, these ceramics are non ferro-electric materials with a low dielectric constant ( $\epsilon_r \leq 110$ ).

Other additives are used to dope the dielectric constant up to 300. Though derogating from CG class, doped dielectric constant features a linear temperature drift and a matchless stability compared with class 2 ceramics.

The wide range of possible NPO dielectric compositions enables to use the material best suited to the application :

- standard applications,
- high voltage,
- high temperature,
- microwave,
- power capacitors.

«Temperature coefficient» compositions are particularly suitable for impedance matching. These ceramics usually enable to achieve temperature coefficients from 0 to  $-1000 \text{ ppm}/^\circ\text{C}$ . For specific requirements, other coefficients can be achieved (e.g.  $-3300 \text{ ppm}/^\circ\text{C}$ ).

## STABILITY

As  $\epsilon_r$  is low, these dielectrics are extremely stable with only minor changes under such stresses as :

- temperature,
- voltage,
- frequency.

In addition, they are not affected by piezo-electric phenomena and their dielectric absorption coefficients are low and even non measurable for dielectrics with the lowest constants.

## MECHANICAL PROPERTIES

Class 1 ceramics are the perfect match for metallic electrodes made of Pd or Ag-Pd alloy and have a high hardness and mechanical toughness making them resistant to thermal shocks (wave soldering for instance) and to thermal cycling after mounting on substrates having an expansion coefficient close to the capacitor one.

Ceramic chips meet CECC 32100 and NF C 93133 standards.

## CLIMATIC CATEGORIES

Climatic categories are identified by three-digit codes as per NF C 20700 standard. Coding method is described in table 6.

e.g. :  $-55^\circ\text{C} + 125^\circ\text{C} / 56$  days category is identified by code 434.

## TEMPERATURE COEFFICIENT

Temperature coefficient $k\theta$ (ppm/ $^\circ\text{C}$ )		
$k\theta$	Tolerances	Code letter
+ 100	$\pm 30$	AG
0	$\pm 30$	CG
- 33	$\pm 30$	HG
- 75	$\pm 30$	LG
- 150	$\pm 30$	PG
- 220	$\pm 30$	RG
- 330	$\pm 60$	SH
- 470	$\pm 60$	TH
- 750	$\pm 120$	UJ
- 1 000	$\pm 250$	QK

# General Information NPO/COG (Class 1)

STANDARD

IMPEDANCE VERSUS FREQUENCY

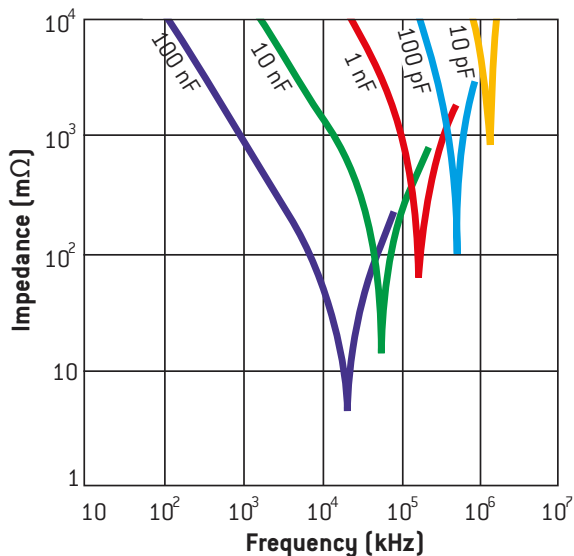

DISSIPATION FACTOR VERSUS FREQUENCY

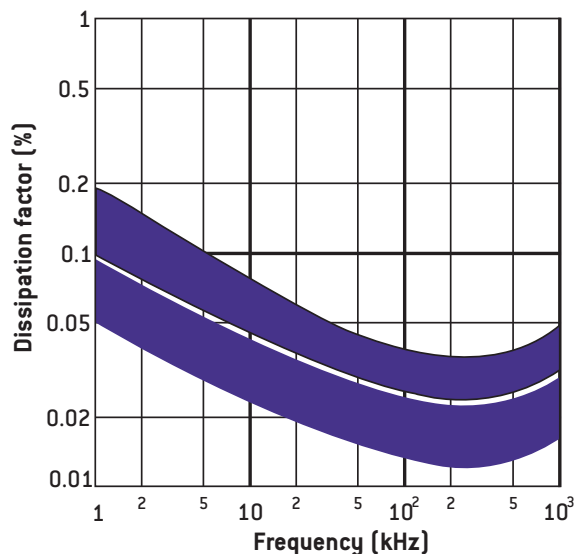

CAPACITANCE CHANGE VERSUS TEMPERATURE

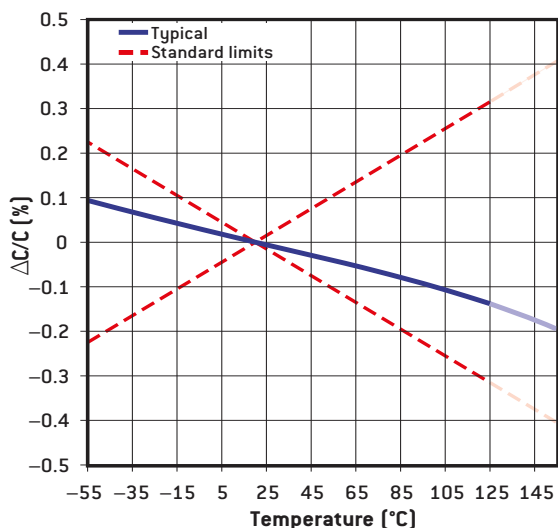

IR VERSUS TEMPERATURE

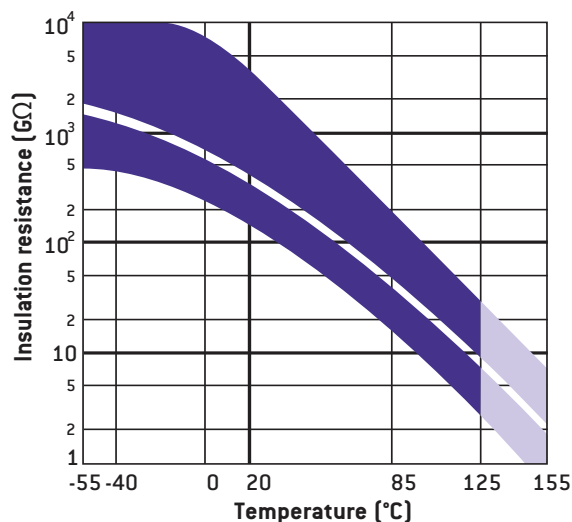

DISSIPATION FACTOR VERSUS TEMPERATURE

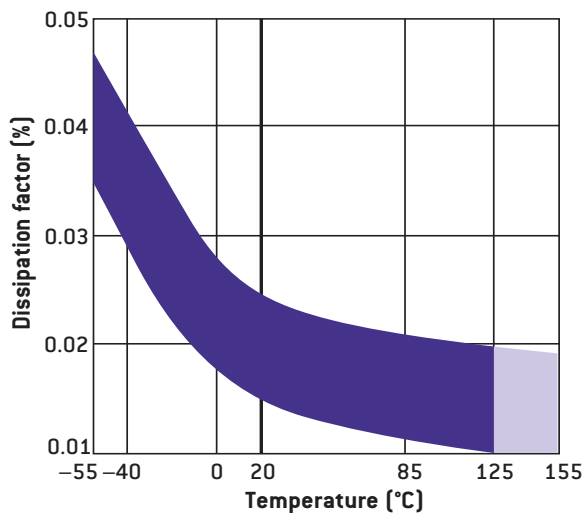

TYPICAL FAILURE RATE VERSUS TEMPERATURE

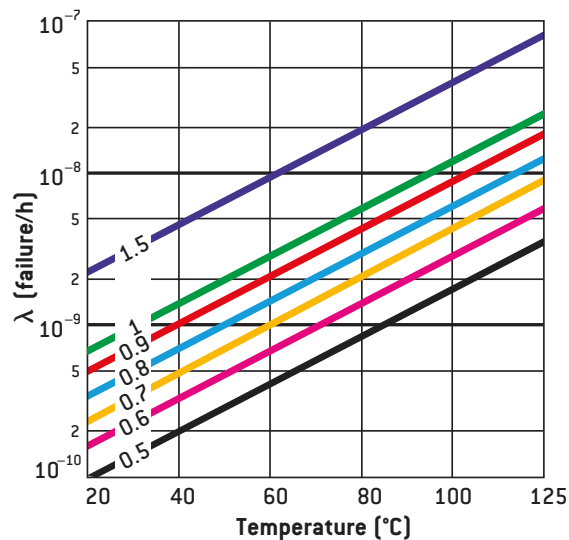

# General Information X7R (Class 2)

## COMPOSITION

Class 2 capacitors are produced by using a dielectric made of barium titanate (Ba Ti O<sub>3</sub>). By nature, the dielectric is a ferroelectric compound with a high dielectric constant usually varying :

- from 1000 to 5000 - typical of capacitors meeting 2C1 type specifications (BX, X7R),
- from 5000 to 15000 - typical of capacitors meeting Z5U or Y5V type specifications.

Depending on whether the dielectric contains a flux additive, mainly bismuth or boron, electrodes are made of Ag-Pd alloys with high silver content or high palladium content, even pure palladium in some cases.

## STABILITY

As the dielectric is a ferro-electric material, class 2 capacitors present significant variations under such stresses as :

- temperature,
- voltage,
- frequency.

In addition, the dielectric absorption coefficient can reach a few % and piezo-electric phenomena can affect the dielectric at critical frequencies (full information and specific documents available on request).

## MECHANICAL PROPERTIES

Class 2 dielectrics are hard materials and are sensitive to thermo-mechanical stress. Stress should be limited when mounting and adequate substrates with an adapted expansion coefficient used.

## BISMUTH OR BISMUTH FREE DIELECTRICS

Class 2 capacitors are made of ceramics capable to embed a flux element (e.g. bismuth or boron salt). Their eventual use will affect the choice of electrode alloys firing temperature used. Capacitor behavior under such constraints as temperature, voltage, frequency and even reliability, in some applications (further information available on request), is also different.

That is why French and European standard authorities have decided to differentiate bismuth from bismuth free ceramics by measuring tangent  $\delta$  at -55°C. Tangent  $Tg \delta$  (-55°C)  $350.10^{-4}$  in flux free dielectrics.

Flux free dielectrics are identified by suffix «A» after capacitor type (e.g. CNC2A).

## CAPACITANCE/TEMPERATURE RELATIONSHIP

Capacitance variations are defined within a specified temperature range, +20°C being the reference temperature. This characteristic is expressed by associating the temperature range and capacitance stability.

Stability category Code letter	Max. capacitance variation (%) with reference to capacitance at 20°C	
	Without voltage	At rated DC voltage (U <sub>DC</sub> )
B	± 10	+ 10– 15
C	± 20	+ 20– 30
D	+ 20 – 30	+ 20 – 40
E	+ 20 – 55	+ 20 – 65
R	+ 15 – 15	Not applicable
X	+ 15 – 15	+ 15 – 25

Temperature category	
Code	Temperature range
1	- 55°C + 125°C
2	- 55°C + 85°C
4	- 25°C + 85°C

## CAPACITANCE CHANGE VERSUS FREQUENCY

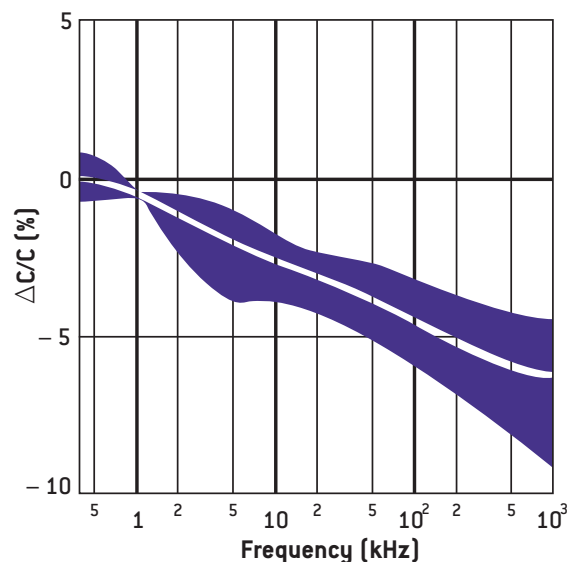

# General Information X7R (Class 2)

STANDARD

IMPEDANCE VERSUS FREQUENCY

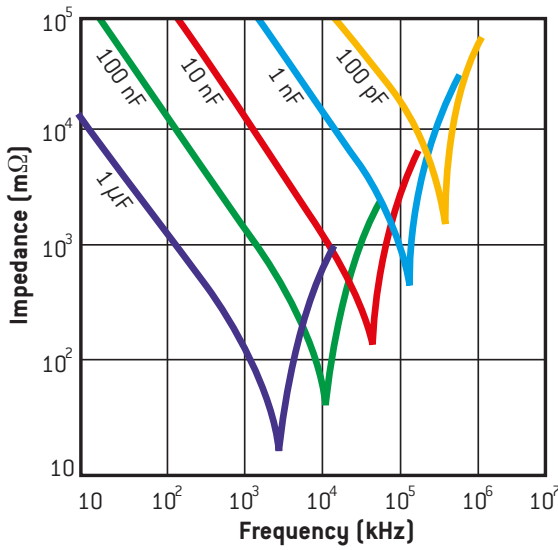

DISSIPATION FACTOR VERSUS FREQUENCY

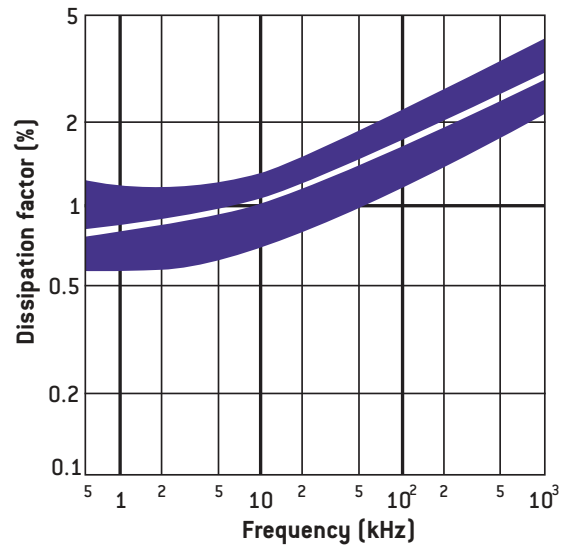

DISSIPATION FACTOR VERSUS TEMPERATURE

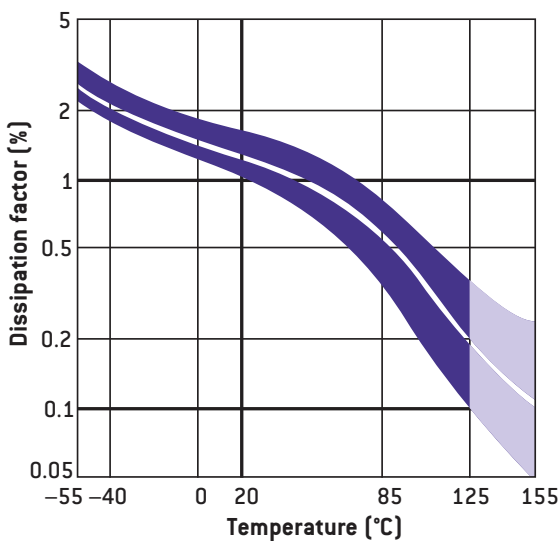

CAPACITANCE CHANGE VERSUS TEMPERATURE

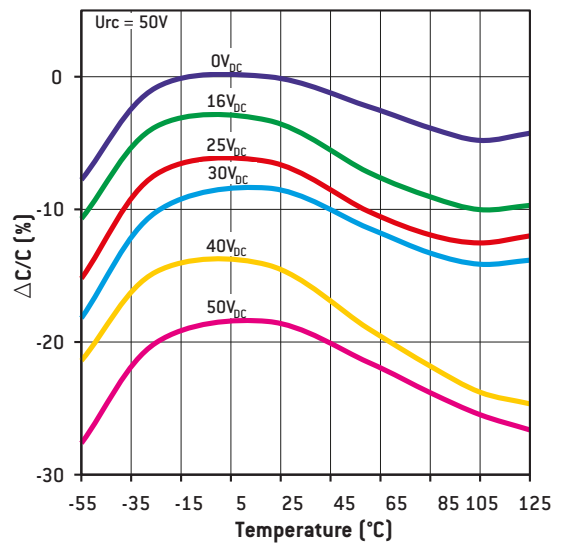

IR VERSUS TEMPERATURE

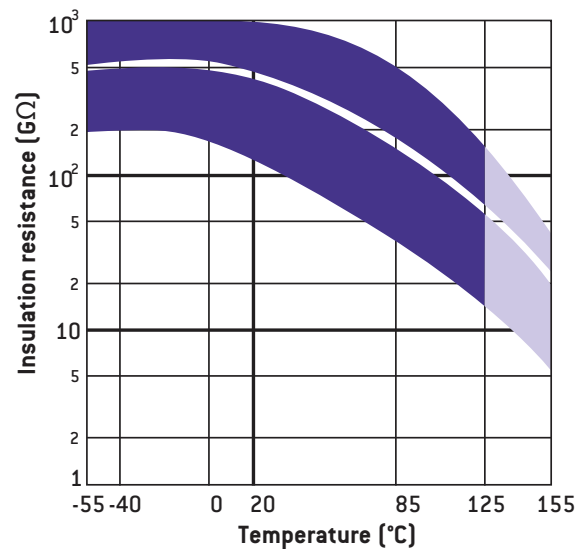

TYPICAL FAILURE RATE VERSUS TEMPERATURE

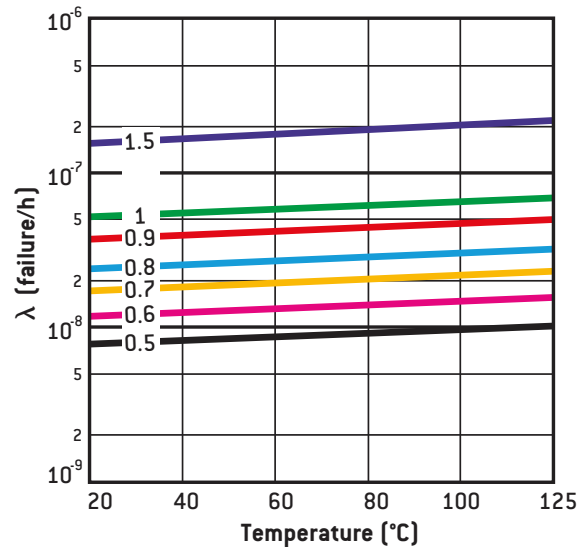

# CEC / CNC Series

## Low and Medium Voltage Chips Capacitors



**Qualified**  
Available space ranges:  
consult our detail  
specifications

In accordance with the specifications of **CECC 32101** and **NF C 93133** standards

### FEATURES

- Case sizes: 0402 - 3040
- NPO, BX, 2C1, X7R dielectrics
- Capacitance range: 1pF to 12μF
- Ag/Pd/Pt, Ni barrier, epoxy terminations available
- RoHS and Non RoHS compliant capacitors available
- Screening in accordance with ESA specifications available

### PHYSICAL CHARACTERISTICS

#### CONSTRUCTION

MLCC capacitors for surface mounting with optional Nickel barrier

#### MARKING (on request)

Capacitance value coded (from 0805 to 3040 sizes).

#### PACKAGING (see page 13)

S8\* = available for 0402 to 1210 sizes.

S12\* = available for 1812 to 2220 sizes.

BA\* = available for 0402 to 2220 (except 0907) sizes.

\* not available with H, HW and E, EW terminations

### HOW TO ORDER

CNC4	-	C	M	F	56nF	10%	50V	S8	T5	
Series	Bismuth	Termination	Marking	Quality level	Capacitance	Tolerance	Rated voltage	Packaging	Reliability level	
<b>CEC ••</b> NPO Ceramic  <b>CNC ••</b> BX, 2C1, 2R1/X7R Ceramics  See Ratings and Case code table	<b>Option A</b> [= bismuth free dielectric] available on request. Please consult us.	<b>W = RoHS compliant</b> - Ag/Pd/Pt <b>W</b> Ag/Pd/Pt Q Ag* <b>QW</b> Ag T Ag + Ni + dipped Sn/Pb 60/40** <b>T</b> H Ag/Pd/Pt + dipped Sn/Pb 60/40 <b>HW</b> Ag/Pd/Pt + dipped Sn C Ag + Ni + electrolytic Sn/Pb 95/5 <b>CW</b> Ag + Ni + electrolytic Sn D Ag + Ni + electrolytic Sn/Pb 60/40 <b>D</b> E Ag + Ni + dipped Sn/Pb 60/40 <b>EW</b> Ag + Ni + electrolytic Sn G Ag + Ni + Au <b>GW</b> Ag + Ni + Au YC Ag + Polymer + Ni + Sn/Pb 95/5 <b>YCW</b> Ag + Polymer + Ni + Sn YD Ag + Polymer + Ni + Sn/Pb 60/40 <b>YD</b> YG Ag + Polymer + Ni + Au <b>YGW</b> Ag + Polymer + Ni + Au  * Only 1812 to 3040 sizes ** Maintenance only		- = no marking  <b>M = Marking:</b> capacitance value coded  (from 0805 to 3040 sizes).	- = standard quality level  <b>F = Hi-Rel quality:</b> screening in accordance with Exxelia specification	Capacitance value in clear	NPO: cap. value ≤ 12pF <b>±0.25pF</b>  cap. value ≤ 8.2pF <b>±0.5pF</b> <b>±1pF</b>  cap. value > 22pF <b>±1%</b>  cap. value > 12pF <b>±2%</b>  cap. value > 8.2pF <b>±5%</b> <b>±10%</b>  cap. value > 3.9pF <b>±20%</b>  BX, 2C1 and X7R: <b>±5%</b> <b>±10%</b> <b>±20%</b>	10V 16V 25V 50V 100V 200V 500V 1000V  Intermediary and higher voltages available on request.	- = Exxelia packaging  <b>S8*</b> = available for 0402 to 1210 sizes.  <b>S12*</b> = available for 1812 to 2220 sizes.  <b>BA*</b> = available for 0402 to 2220 (except 0907) sizes.  * not available with H, HW and E, EW terminations see page 13	For F parts only. Acc. to Exxelia spec. - <b>T5</b> <b>T6</b>  See page 15

### ELECTRICAL SPECIFICATIONS

Description	NPO
Operating temperature	-55°C to +125°C
Climatic category	55 / 125 / 56
Rated voltage (U <sub>RC</sub> )	10V <sub>DC</sub> to 1,000V <sub>DC</sub>
Maximum ΔC/°C over temperature range without DC voltage applied	NA
Maximum ΔC/°C over temperature range with rated voltage applied	NA
Temperature coefficient with or without DC voltage applied	(0 ± 30) ppm/°C
Dielectric withstanding voltage	2.5 U <sub>RC</sub> for U <sub>RC</sub> ≤ 500V <sub>DC</sub>
	1.6 U <sub>RC</sub> for U <sub>RC</sub> = 1,000V <sub>DC</sub>
	1.5 U <sub>RC</sub> for U <sub>RC</sub> = 1,000V <sub>DC</sub>
Capacitance	at 1MHz for C ≤ 1,000pF
	at 1kHz for C > 1,000pF
Dissipation factor at 25°C	≤ 0.015 (150/C + 7)% at 1MHz for C ≤ 50pF
	≤ 0.15% at 1MHz for 50pF < C ≤ 1,000pF
	≤ 0.15% at 1kHz for C > 1,000pF
Insulation resistance at 25°C	under U <sub>RC</sub> for U <sub>RC</sub> ≤ 500V <sub>DC</sub>
	under 500V <sub>DC</sub> for U <sub>RC</sub> > 500V <sub>DC</sub>
	≥ 100,000 MΩ for C ≤ 10nF ≥ 1,000 MΩ.μF for C > 10nF
Aging	None

Description	BX	2C1	X7R
Operating temperature	-55°C to +125°C	-55°C to +125°C	-55°C to +125°C
Climatic category	55 / 125 / 56	55 / 125 / 56	55 / 125 / 56
Rated voltage (U <sub>RC</sub> )	10V <sub>DC</sub> to 500V <sub>DC</sub>	10V <sub>DC</sub> to 500V <sub>DC</sub>	10V <sub>DC</sub> to 1,000V <sub>DC</sub>
Maximum ΔC/°C over temperature range without DC voltage applied	± 15%	± 15%	± 15%
Maximum ΔC/°C over temperature range with rated voltage applied	+15% -25%	+15% -30%	NA
Temperature coefficient with or without DC voltage applied	NA	NA	NA
Dielectric withstanding voltage	2.5 U <sub>RC</sub>	2.5 U <sub>RC</sub>	2.5 U <sub>RC</sub> for U <sub>RC</sub> ≤ 500V <sub>DC</sub>
Capacitance	at 1MHz for C ≤ 100pF		
	at 1kHz for C > 100pF		
Dissipation factor at 25°C	≤ 2.5% at 1MHz for C ≤ 100pF		
	≤ 2.5% at 1kHz for C > 100pF		
Insulation resistance at 25°C	under U <sub>RC</sub> for U <sub>RC</sub> ≤ 500V <sub>DC</sub>		
	under 500V <sub>DC</sub> for U <sub>RC</sub> > 500V <sub>DC</sub>		
	≥ 100,000 MΩ for C ≤ 10nF ≥ 1,000 MΩ.μF for C > 10nF		
Aging	≤ 2.5% per decade hour		

Low and Medium Voltage Chips Capacitors

CEC / CNC Series

DIMENSIONS in inches (mm)

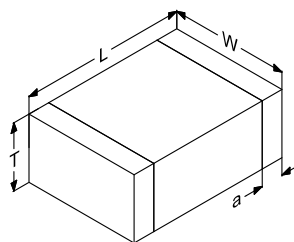

STANDARD RATINGS

Series	CEC/CNC 19				CEC/CNC 17				CEC/CNC 14				
Size	0402				0403				0603				
Dimensions inches (mm)	L	0.039 ± 0.004 (1 ± 0.1)				0.039 ± 0.004 (1 ± 0.1)				0.063 ± 0.006 (1.6 ± 0.15)			
	W	0.02 ± 0.004 (0.5 ± 0.1)				0.03 ± 0.004 (0.76 ± 0.1)				0.032 ± 0.006 (0.8 ± 0.15)			
	a	0.004 min (0.1) min				0.004 min (0.1) min				0.012 ± 0.008 (0.3 ± 0.2)			
	T max.	0.024 (0.6)				0.032 (0.8)				0.04 (1)			
Dielectric	NPO	BX	2C1	X7R	NPO	BX	2C1	X7R	NPO	BX	2C1	X7R	
Min. Capa. value	1pF	10pF			1pF	10pF			1pF	10pF			
Rated voltage (U <sub>RC</sub> )	10V	390pF	15nF	15nF	15nF	1.2nF	47nF	47nF	47nF	3.3nF	120nF	120nF	120nF
	16V	270pF	12nF	12nF	15nF	820pF	39nF	39nF	47nF	2.7nF	120nF	120nF	120nF
	25V	180pF	4.7nF	5.6nF	5.6nF	470pF	15nF	18nF	18nF	1.8nF	56nF	56nF	56nF
	50V	82pF	1.2nF	2.2nF	3.9nF	330pF	3.9nF	5.6nF	12nF	820pF	12nF	18nF	33nF
	63V	68pF	820pF	1.2nF	3.9nF	220pF	2.2nF	3.9nF	12nF	680pF	8.2nF	12nF	33nF
	100V	39pF	330pF	560pF	1.2nF	120pF	1nF	1.8nF	3.3nF	330pF	3.3nF	5.6nF	12nF

Series	CEC/CNC 1				CEC/CNC 2				CEC/CNC 18				CEC/CNC 8						
Size	0504				0805				0907				1005						
Dimensions inches (mm)	L	0.049 ± 0.008 (1.25 ± 0.2)				0.079 ± 0.012 (2 ± 0.3)				0.091 ± 0.012 (2.3 ± 0.3)				0.098 ± 0.012 (2.5 ± 0.3)					
	W	0.039 ± 0.008 (1 ± 0.2)				0.049 ± 0.008 (1.25 ± 0.2)				0.071 ± 0.01 (1.8 ± 0.25)				0.049 ± 0.008 (1.25 ± 0.2)					
	a	0.004 min (0.1) min				0.02 ± 0.012 (0.5 ± 0.3)				0.02 ± 0.012 (0.5 ± 0.3)				0.024 ± 0.016 (0.6 ± 0.4)					
	T max.	0.04 (1)				0.052 (1.3)				0.06 (1.5)				0.052 (1.3)					
Dielectric	NPO	BX	2C1	X7R	NPO	NPO Ext.	BX	2C1	X7R	X7R Ext.	NPO	BX	2C1	X7R	NPO	BX	2C1	X7R	
Min. Capa. value	1pF	10pF			1pF		10pF			1pF		47pF		1pF	33pF				
Rated voltage (U <sub>RC</sub> )	10V	3.3nF	120nF	120nF	120nF	12nF	-	470nF	470nF	470nF	-	18nF	820nF	820nF	820nF	3.3nF	100nF	100nF	100nF
	16V	3.3nF	120nF	120nF	120nF	12nF	-	470nF	470nF	470nF	-	18nF	680nF	680nF	680nF	3.3nF	100nF	100nF	100nF
	25V	1.8nF	56nF	56nF	56nF	6.8nF	-	220nF	220nF	220nF	-	12nF	330nF	390nF	390nF	2.2nF	68nF	68nF	68nF
	50V	1.2nF	15nF	22nF	33nF	3.3nF	-	56nF	82nF	120nF	-	5.6nF	82nF	120nF	150nF	1.8nF	56nF	56nF	56nF
	63V	820pF	8.2nF	15nF	33nF	2.7nF	-	33nF	47nF	120nF	-	4.7nF	56nF	82nF	120nF	1.8nF	39nF	56nF	56nF
	100V	390pF	3.3nF	6.8nF	12nF	1.5nF	-	12nF	27nF	39nF	-	2.7nF	22nF	39nF	68nF	1nF	12nF	18nF	18nF
	200V	-	-	-	-	390pF	820pF	3.3nF	5.6nF	10nF	22nF	680pF	4.7nF	8.2nF	12nF	390pF	3.9nF	5.6nF	6.8nF
	500V	-	-	-	-	100pF	470pF	-	560pF	1.2nF	5.6nF	180pF	-	1nF	1.5nF	120pF	-	560pF	820pF
	1,000V	-	-	-	-	-	-	-	-	-	-	-	-	-	-	-	-	-	-

# CEC / CNC Series

Low and Medium Voltage Chips Capacitors

## DIMENSIONS in inches (mm)

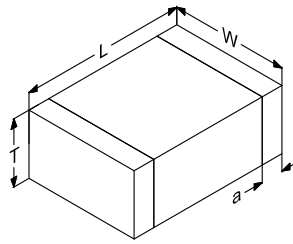

## STANDARD RATINGS

Series	CEC/CNC 12						CEC/CNC 4						CEC/CNC 9			CEC/CNC 3						
Size	1206						1210						1605			1806						
Dimensions inches (mm)	L	0.126 ± 0.01 (3.2 ± 0.25)						0.126 ± 0.016 (3.2 ± 0.4)						0.158 ± 0.02 (4 ± 0.5)			0.177 ± 0.02 (4.5 ± 0.5)					
	W	0.063 ± 0.006 (1.6 ± 0.15)						0.098 ± 0.012 (2.5 ± 0.3)						0.05 ± 0.008 (1.25 ± 0.2)			0.063 ± 0.008 (1.6 ± 0.2)					
	a	0.02 ± 0.012 (0.5 ± 0.3)						0.024 ± 0.016 (0.6 ± 0.4)						0.024 ± 0.016 (0.6 ± 0.4)			0.024 ± 0.016 (0.6 ± 0.4)					
	T max.	0.063 (1.6)						0.071 (1.8)						0.05 (1.25)			0.063 (1.6)					
Dielectric	NPO	NPO Ext.	BX	2C1	X7R	X7R Ext.	NPO	NPO Ext.	BX	2C1	X7R	X7R Ext.	NPO	BX	2C1	X7R	NPO	BX	2C1	X7R		
Min. Cap. value	1pF		100pF				10pF		180pF				10pF		220pF			47pF		390pF		
Rated voltage (U <sub>RC</sub> )	10V	22nF	-	1.2μF	1.2μF	1.2μF	-	56nF	-	2.2μF	2.2μF	2.2μF	-	6.8nF	150nF	150nF	150nF	12nF	330nF	330nF	330nF	
	16V	22nF	-	820nF	1.2μF	1.2μF	-	56nF	-	2.2μF	2.2μF	2.2μF	-	6.8nF	150nF	150nF	150nF	12nF	330nF	330nF	330nF	
	25V	15nF	-	330nF	680nF	680nF	-	39nF	-	1μF	1μF	1μF	-	4.7nF	100nF	100nF	100nF	8.2nF	220nF	220nF	220nF	
	50V	6.8nF	-	150nF	220nF	270nF	-	18nF	-	330nF	470nF	560nF	-	3.9nF	68nF	82nF	82nF	6.8nF	150nF	180nF	180nF	
	63V	6.8nF	-	100nF	150nF	180nF	-	15nF	-	180nF	270nF	560nF	-	3.3nF	56nF	68nF	82nF	5.6nF	100nF	150nF	180nF	
	100V	3.9nF	-	39nF	68nF	120nF	-	8.2nF	-	82nF	150nF	220nF	-	2.2nF	27nF	27nF	33nF	3.9nF	39nF	56nF	56nF	
	200V	1.2nF	3.3nF	8.2nF	15nF	27nF	100nF	2.2nF	5.6nF	18nF	33nF	56nF	180nF	820pF	6.8nF	10nF	12nF	1.2nF	8.2nF	12nF	18nF	
	500V	330pF	1.5nF	820pF	2.2nF	3.9nF	18nF	680pF	2.7nF	1.8nF	3.9nF	8.2nF	39nF	220pF	-	1.2nF	1.5nF	330pF	820pF	1.8nF	2.7nF	
	1,000V	120pF	680pF	-	-	560pF	4.7nF	220pF	1nF	-	-	1.2nF	10nF	82pF	-	-	-	120pF	-	-	560pF	

Series	CEC/CNC 6						CEC/CNC 70				CEC/CNC 5				CEC/CNC 7						
Size	1812						1825				2210				2220						
Dimensions inches (mm)	L	0.177 ± 0.02 (4.5 ± 0.5)						0.177 ± 0.020 (4.5 ± 0.5)				0.224 ± 0.02 (5.7 ± 0.5)				0.224 ± 0.02 (5.7 ± 0.5)					
	W	0.126 ± 0.016 (3.2 ± 0.4)						0.250 ± 0.020 (6.35 ± 0.5)				0.098 ± 0.012 (2.5 ± 0.3)				0.197 ± 0.02 (5 ± 0.5)					
	a	0.024 ± 0.016 (0.6 ± 0.4)						0.024 ± 0.020 (0.6 ± 0.4)				0.024 ± 0.016 (0.6 ± 0.4)				0.024 ± 0.016 (0.6 ± 0.4)					
	T max.	0.071 (1.8)						0.071 (1.8)				0.067 (1.7)				0.071 (1.8)					
Dielectric	NPO	NPO Ext.	BX	2C1	X7R	X7R Ext.	NPO	BX	2C1	X7R	NPO	BX	2C1	X7R	NPO	NPO Ext.	BX	2C1	X7R	X7R Ext.	
Min. Cap. value	47pF		470pF				100pF		1nF		220pF		1nF		100pF		1.2nF				
Rated voltage (U <sub>RC</sub> )	10V	82nF	-	4.7μF	4.7μF	4.7μF	-	150nF	4.7μF	4.7μF	4.7μF	39nF	680nF	680nF	680nF	180nF	-	10μF	10μF	10μF	-
	16V	82nF	-	3.3μF	3.3μF	4.7μF	-	150nF	2.7μF	2.7μF	2.7μF	39nF	680nF	680nF	680nF	180nF	-	8.2μF	8.2μF	10μF	-
	25V	39nF	-	2.2μF	2.2μF	2.2μF	-	82nF	2.2μF	2.2μF	2.2μF	22nF	470nF	470nF	470nF	82nF	-	4.7μF	4.7μF	4.7μF	-
	50V	27nF	-	560nF	820nF	1.2μF	-	56nF	1.2μF	1.5μF	1.5μF	18nF	390nF	390nF	390nF	56nF	-	1.2μF	2.2μF	2.7μF	-
	63V	22nF	-	330nF	470nF	1μF	-	47nF	680nF	1μF	1μF	15nF	330nF	390nF	390nF	47nF	-	820nF	1.5μF	2.7μF	-
	100V	15nF	-	150nF	270nF	470nF	1μF	22nF	270nF	560nF	820nF	10nF	100nF	180nF	180nF	33nF	-	270nF	680nF	1μF	-
	200V	4.7nF	12nF	27nF	47nF	68nF	330nF	8.2nF	56nF	100nF	180nF	3.9nF	27nF	47nF	68nF	10nF	27nF	56nF	120nF	220nF	820nF
	500V	1.2nF	5.6nF	2.7nF	6.8nF	10nF	82nF	2.2nF	5.6nF	12nF	27nF	1nF	2.7nF	5.6nF	8.2nF	2.7nF	15nF	5.6nF	15nF	27nF	180nF
	1,000V	470pF	2.7nF	-	-	2.2nF	22nF	820pF	-	-	3.9nF	470pF	-	-	1.8nF	1nF	6.8nF	-	-	3.9nF	39nF



DIMENSIONS in inches (mm)

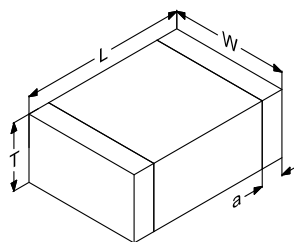

STANDARD RATINGS

Series	CEC/CNC 71				CEC/CNC W				CEC/CNC X				CEC/CNC 72				
Size	2225				2528				3030				3040				
Dimensions inches (mm)	L	0.224 ± 0.02 (5.7 ± 0.5)				0.250 ± 0.020 (6.35 ± 0.5)				0.299 ± 0.02 (7.6 ± 0.5)				0.299 ± 0.02 (7.6 ± 0.5)			
	w	0.250 ± 0.020 (6.35 ± 0.5)				0.276 ± 0.020 (7 ± 0.5)				0.299 ± 0.02 (7.6 ± 0.5)				0.4 ± 0.02 (10.16 ± 0.5)			
	a	0.024 ± 0.020 (0.6 ± 0.4)				0.024 ± 0.020 (0.6 ± 0.4)				0.024 ± 0.016 (0.6 ± 0.4)				0.024 ± 0.016 (0.6 ± 0.4)			
	T <sub>max.</sub>	0.079 (2)				0.079 (2)				0.079 (2)				0.079 (2)			
Dielectric	NPO	BX	2C1	X7R	NPO	BX	2C1	X7R	NPO	BX	2C1	X7R	NPO	BX	2C1	X7R	
Min. Cap. value	150pF	1.5nF			270pF	2.7nF			390pF	4.7nF			680pF	8.2nF			
Rated voltage (U <sub>RC</sub> )	10V	180nF	5.6µF	5.6µF	5.6µF	220nF	6.8µF	6.8µF	6.8µF	330nF	10µF	10µF	10µF	470nF	12µF	12µF	12µF
	16V	180nF	3.3µF	3.3µF	4.7µF	220nF	3.9µF	3.9µF	3.9µF	330nF	6.8µF	6.8µF	6.8µF	470nF	8.2µF	8.2µF	8.2µF
	25V	100nF	2.2µF	2.2µF	3.9µF	120nF	2.7µF	2.7µF	2.7µF	180nF	3.9µF	3.9µF	3.9µF	270nF	5.6µF	5.6µF	5.6µF
	50V	68nF	1.2µF	1.5µF	2.2µF	82nF	1.5µF	1.8µF	1.8µF	120nF	2.7µF	2.7µF	2.7µF	150nF	3.3µF	3.9µF	3.9µF
	63V	56nF	820nF	1.2µF	1.5µF	68nF	1µF	1.5µF	1.8µF	100nF	1.5µF	2.2µF	2.2µF	120nF	2.2µF	2.7µF	3.3µF
	100V	33nF	390nF	680nF	1.2µF	33nF	390nF	820nF	1.2µF	56nF	680nF	1.2µF	1.5µF	82nF	1µF	1.8µF	2.2µF
	200V	12nF	68nF	120nF	270nF	15nF	82nF	150nF	270nF	22nF	150nF	270nF	470nF	33nF	180nF	390nF	560nF
	500V	3.3nF	5.6nF	15nF	33nF	3.9nF	8.2nF	18nF	33nF	6.8nF	12nF	33nF	68nF	8.2nF	22nF	56nF	100nF
	1,000V	1.2nF	-	-	4.7nF	1.5nF	-	-	5.6nF	2.7nF	-	-	10nF	3.3nF	-	-	15nF

Available capacitance values:

NPO: E6, E12, E24, E48, E96 (see page 14). Specific values upon request.

X7R: E6, E12, E24 (see page 14). Specific values upon request.

The above table defines the standard products, other components may be built upon request.

Other temperature coefficients, temperature characteristic 2B1 and Bismuth free dielectrics are available: contact your sales representative.

# Non Magnetic Chips Series

Low and Medium Voltage Chips Capacitors

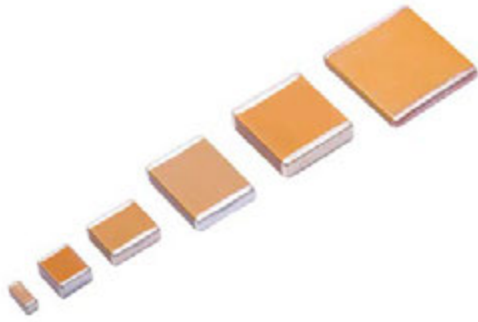

## FEATURES

- Case sizes: 0603 to 2220
- NPO and X7R dielectrics
- Capacitance range: 10pF to 1μF
- RoHS compliant capacitors

## PHYSICAL CHARACTERISTICS

MLCC capacitors with:

- Copper barrier + pur Tin or Silver Palladium terminations for surface mounting.

## PACKAGING

Sizes	Ag/Pd/Pt termination [A code]	Cu termination [C code]
	Parts / reel *	Parts / reel *
R14 (0603)	[C code]*	3,000 / 4,000
R15 (0805)	Parts / reel *	Parts / reel *
R18 (1206)	3,000 - 4,000	3,000
S41 (1210)	2,000 - 4,000	1,000 - 2,000 - 3,000
S43 (1812)	500 - 1,000	-
S47 (2220)	500 - 1,000	-

\* Note: the quantity of parts in a reel depends upon their thicknesses.

Please, consult us for more accurate data.

## ELECTRICAL SPECIFICATIONS

Description	NPO dielectric	X7R dielectric
Dielectric code	N	X
CECC class	1B / CG	2R1
EIA class	Class I	Class II
Temperature range	-55°C to +125°C	-55°C to +125°C
Temperature coefficient	(0 ± 30) ppm/°C	NA
Maximum ΔC/°C over temperature range without DC voltage applied	NA	± 15%
Rated voltage (U <sub>R</sub> )	100V <sub>DC</sub> to 500V <sub>DC</sub>	63V <sub>DC</sub> to 500V <sub>DC</sub>
Dielectric withstanding voltage	250% rated voltage	250% rated voltage
Insulation resistance (I <sub>R</sub> ) at 25°C under U <sub>R</sub>	100GΩ or 1,000Ω.F whichever is less	100GΩ or 1,000Ω.F whichever is less
Aging	None	≤ 2.5% per decade hour

## HOW TO ORDER

630	S41	N	472	J	C	E
Rated voltage	Exxelia Size Code	Dielectric code	Capacitance	Tolerance	Termination	Packaging
<b>630</b> = 63V <b>101</b> = 100V <b>201</b> = 200V <b>501</b> = 500V	<b>R14</b> = 0603 <b>R15</b> = 0805 <b>R18</b> = 1206 <b>S41</b> = 1210 <b>S43</b> = 1812 <b>S47</b> = 2220	<b>N</b> = NPO <b>X</b> = X7R	Capacitance value in code. 1 <sup>st</sup> two digits represent significant figures; last digit specifies the number of zeros to follow.  Examples: <b>101</b> = 100pF <b>472</b> = 4.7nF <b>683</b> = 68nF <b>564</b> = 0.56μF <b>105</b> = 1μF	<b>NPO:</b> <b>F</b> = ± 1% <b>G</b> = ± 2% <b>J</b> = ± 5% <b>K</b> = ± 10% <b>M</b> = ± 20%  <b>X7R:</b> <b>K</b> = ± 10% <b>M</b> = ± 20%	<b>C</b> = Pure Tin plated Copper barrier on Pure Silver termination  <b>A</b> = Silver Palladium Platinum termination	- = Bulk  <b>E</b> = tape & reel (see packaging paragraph for details)  See page 13

## DIMENSIONS in inches (mm)

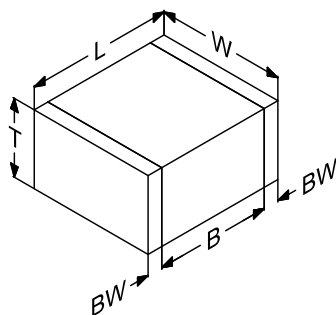

## STANDARD RATINGS

Size		0603				0805				1206			
Exxelia size code		R14				R15				R18			
Termination code		C		A		C		A		C		A	
Dimensions inches (mm)	L	0.063 ± 0.012 (1.6 ± 0.3)		0.063 ± 0.012 (1.6 ± 0.3)		0.079 ± 0.012 (2 ± 0.3)		0.079 ± 0.012 (2 ± 0.3)		0.126 ± 0.012 (3.2 ± 0.3)		0.126 ± 0.012 (3.2 ± 0.3)	
	W	0.032 ± 0.008 (0.8 ± 0.2)		0.032 ± 0.008 (0.8 ± 0.2)		0.049 ± 0.012 (1.25 ± 0.3)		0.049 ± 0.012 (1.25 ± 0.3)		0.063 ± 0.012 (1.6 ± 0.3)		0.063 ± 0.012 (1.6 ± 0.3)	
	B min.	0.015 (0.4)		0.015 (0.4)		0.027 (0.7)		0.019 (0.5)		0.059 (1.5)		0.055 (1.4)	
	BW min.	0.005 (0.15)		0.005 (0.15)		0.007 (0.2)		0.005 (0.13)		0.011 (0.3)		0.009 (0.25)	
	T max.	0.038 (0.95)		0.038 (0.95)		0.058 (1.45)		0.058 (1.45)		0.071 (1.80)		0.071 (1.80)	
Dielectric		NPO	X7R	NPO	X7R	NPO	X7R	NPO	X7R	NPO	X7R	NPO	X7R
Rated voltage (U <sub>nc</sub> )	63V	-	470pF to 22nF	-	4.7nF to 22nF	-	680pF to 22nF	-	10nF to 47nF	-	1nF to 100nF	-	15nF to 100nF
	100V	47pF to 180pF	-	-	-	47pF to 1nF	-	220pF to 1nF	-	100pF to 1nF	-	220pF to 2.2nF	-
	200V	-	-	-	-	-	-	10pF to 220pF	330pF to 4.7nF	-	-	10pF to 1nF	1nF to 10nF
	500V	-	-	-	-	-	-	10pF to 180pF	270pF to 2.2nF	-	-	10pF to 470pF	680pF to 4.7nF

Size		1210				1812				2220			
Exxelia size code		S41				S43				S47			
Termination code		C		A		C		A		C		A	
Dimensions inches (mm)	L	0.126 ± 0.016 (3.2 ± 0.4)		0.126 ± 0.016 (3.2 ± 0.4)		-		0.177 ± 0.02 (4.5 ± 0.5)		-		0.224 ± 0.02 (5.7 ± 0.5)	
	W	0.098 ± 0.012 (2.5 ± 0.3)		0.098 ± 0.012 (2.5 ± 0.3)		-		0.126 ± 0.016 (3.2 ± 0.4)		-		0.197 ± 0.02 (5 ± 0.5)	
	B min.	0.062 (1.6)		0.055 (1.4)		-		0.086 (2.2)		-		0.114 (2.9)	
	BW min.	0.011 (0.3)		0.009 (0.25)		-		0.009 (0.25)		-		0.009 (0.25)	
	T max.	0.103 (2.6)		0.099 (2.5)		-		0.119 (3)		-		0.119 (3)	
Dielectric		NPO	X7R	NPO	X7R	NPO	X7R	NPO	X7R	NPO	X7R	NPO	X7R
Rated voltage (U <sub>nc</sub> )	63V	-	3.3nF to 100nF	-	33nF to 330nF	-	150nF to 1µF	-	150nF to 1µF	-	330nF to 1µF	-	330nF to 1µF
	100V	100pF to 4.7pF	-	470pF to 5.6nF	-	1.8nF to 5.6nF	-	1.8nF to 5.6nF	-	6.8nF to 10nF	-	6.8nF to 10nF	-
	200V	-	-	100pF to 2.7nF	1.5nF to 4.7nF	180pF to 5.6nF	2.7nF to 100nF	180pF to 5.6nF	2.7nF to 100nF	680pF to 10nF	6.8nF to 220nF	680pF to 10nF	6.8nF to 220nF
	500V	-	-	100pF to 1nF	1.5nF to 22nF	180pF to 2.2nF	2.7nF to 47nF	180pF to 2.2nF	2.7nF to 47nF	680pF to 4.7nF	6.8nF to 100nF	680pF to 4.7nF	6.8nF to 100nF

Available capacitance values:

E6, E12 (see page XX). Specific values upon request.

Note: some capacitance values in these tables may not be proposed for small quantities. Please, contact us for confirmation.

# OP Series

## Open Mode Chips Capacitors

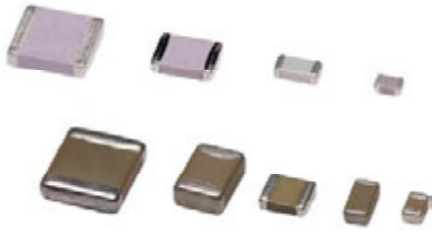

### FEATURES

- Case sizes: 0805 to 2220
- NPO and X7R dielectrics
- Capacitance range: 1pF to 4.7μF
- Designed to significantly minimize the probability of short circuit or low IR failure due to board flexion
- Ag/Pd/Pt, Ni barrier, epoxy terminations available
- RoHS and Non RoHS compliant capacitors available
- Screening in accordance with ESA specifications available

### PHYSICAL CHARACTERISTICS

#### CONSTRUCTION

MLCC capacitors for surface mounting with optional Nickel barrier

#### MARKING (on request)

Capacitance value code

### ELECTRICAL SPECIFICATIONS

Description	NPO	X7R
<b>Operating temperature</b>	-55°C to +125°C*	-55°C to +125°C*
<b>Climatic category</b>	55 / 125 / 56	55 / 125 / 56
<b>Rated voltage (U<sub>RC</sub>)</b>	10V <sub>DC</sub> to 100V <sub>DC</sub>	10V <sub>DC</sub> to 100V <sub>DC</sub>
<b>Maximum ΔC/°C over temperature range without DC voltage applied</b>	NA	±15%
<b>Temperature coefficient with or without DC voltage applied</b>	(0 ± 30)ppm/°C	NA
<b>Dielectric withstanding voltage</b>	2.5 U <sub>RC</sub>	2.5 U <sub>RC</sub>
<b>Capacitance</b>	at 1MHz for C ≤ 1,000pF at 1kHz for C > 1,000pF	at 1MHz for C ≤ 100pF at 1kHz for C > 100pF
<b>Dissipation factor at 25°C</b>	≤ 0.015 (150/C + 7)% at 1MHz for C ≤ 50pF ≤ 0.15% at 1MHz for 50pF < C ≤ 1,000pF ≤ 0.15% at 1kHz for C > 1,000pF	≤ 2.5% at 1MHz for C ≤ 100pF ≤ 2.5% at 1kHz for C > 100pF
<b>Insulation resistance at 25°C under U<sub>RC</sub></b>	≥ 100,000 MΩ for C ≤ 10nF ≥ 1,000 MΩ.μF for C > 10nF	≥ 100,000 MΩ for C ≤ 10nF ≥ 1,000 MΩ.μF for C > 10nF
<b>Aging</b>	None	≤ 2.5% per decade hour

Other temperature coefficients, temperature characteristics 2B1, BX, BR and Bismuth free dielectrics are available.

\* Operating temperature up to 250°C available upon request. Contact your sales representative.

### HOW TO ORDER

OP	1210	X7R	C	M	F	270nF	10%	50V	S8	T5		
Series	Size	Dielectric	Termination	Marking	Quality level	Capacitance	Tolerance	Rated voltage	Packaging	Reliability level		
OP: Open-mode	0805 1206 1210 1812 2220	NPO X7R	W = RoHS compliant		- = no marking  M = Marking: capacitance value coded (from 0805 to 3040 sizes).	- = standard quality level  F = Hi-Rel quality: screening in accordance with Exxelia specification	Capacitance value in clear	NPO: cap. value ≤ 12pF ± 0.25pF cap. value ≤ 8.2pF ± 0.5pF ± 1pF  cap. value > 22pF ± 1% cap. value > 12pF ± 2% cap. value > 8.2pF ± 5% ± 10% cap. value > 3.9pF ± 20%  X7R: ± 5% ± 10% ± 20%	10V 16V 25V 50V 100V  Intermediary and higher voltages available on request.	- = Exxelia packaging S8* = available for 0402 to 1210 sizes. S12* = available for 1812 to 2220 sizes. BA* = available for 0402 to 2220 (except 0907) sizes.  * not available with H, HW and E, EW terminations See page 13	For F parts only. Acc. to Exxelia spec. - T5 T6 See page 15	
			Ag/Pd/Pt	W								Ag/Pd/Pt
			Ag *	QW								Ag
			Ag + Ni + dipped Sn/Pb 60/40 **	-								-
			Ag/Pd/Pt + dipped Sn/Pb 60/40	HW								Ag/Pd/Pt + dipped Sn
			Ag + Ni + electrolytic Sn/Pb 95/5	CW								Ag + Ni + electrolytic Sn
			Ag + Ni + electrolytic Sn/Pb 60/40	-								-
			Ag + Ni + dipped Sn/Pb 60/40	EW								Ag + Ni + electrolytic Sn
			Ag + Ni + Au	GW								Ag + Ni + Au
			Ag + Polymer + Ni + Sn/Pb 95/5	YCW								Ag + Polymer + Ni + Sn
			Ag + Polymer + Ni + Sn/Pb 60/40	-								-
			Ag + Polymer + Ni + Au	YGW								Ag + Polymer + Ni + Au

\* Only 1812 to 3040 sizes  
\*\* Maintenance only

## Open Mode Chips Capacitors

## OP Series

## DIMENSIONS in inches (mm)

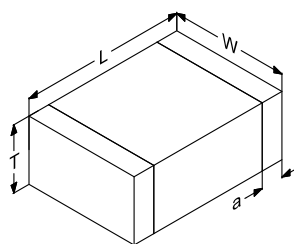

L, W, T for tinned chips [E, EW, H, HW]: +0.02" (+0.5mm)

## STANDARD RATINGS

Size	0805		1206		1210		1812		2220		
Dimensions inches (mm)	L	0.079 ± 0.012 [2 ± 0.3]	0.126 ± 0.01 [3.2 ± 0.25]	0.126 ± 0.016 [3.2 ± 0.4]	0.177 ± 0.02 [4.5 ± 0.5]	0.224 ± 0.02 [5.7 ± 0.5]					
	W	0.049 ± 0.008 [1.25 ± 0.2]	0.063 ± 0.006 [1.6 ± 0.15]	0.098 ± 0.012 [2.5 ± 0.3]	0.126 ± 0.016 [3.2 ± 0.4]	0.197 ± 0.02 [5 ± 0.5]					
	a	0.02 ± 0.012 [0.5 ± 0.3]	0.02 ± 0.012 [0.5 ± 0.3]	0.024 ± 0.016 [0.6 ± 0.4]	0.024 ± 0.016 [0.6 ± 0.4]	0.024 ± 0.016 [0.6 ± 0.4]					
	T <sub>max.</sub>	0.052 [1.3]	0.063 [1.6]	0.071 [1.8]	0.071 [1.8]	0.079 [2]					
Dielectric	NPO	X7R	NPO	X7R	NPO	X7R	NPO	X7R	NPO	X7R	
Min. Cap. value	1pF	10pF	1pF	100pF	10pF	180pF	47pF	470pF	100pF	1.2nF	
Rated voltage (U <sub>rated</sub> )	10V	5.6nF	270nF	18nF	820nF	27nF	1.5μF	47nF	2.7μF	120nF	4.7μF
	16V	5.6nF	220nF	18nF	680nF	27nF	1.2μF	47nF	2.2μF	120nF	3.9μF
	25V	3.3nF	120nF	10nF	330nF	15nF	560nF	27nF	1μF	56nF	2.2μF
	50V	1.8nF	68nF	4.7nF	150nF	6.8nF	330nF	12nF	680nF	27nF	1.5μF
	63V	1.5nF	39nF	3.9nF	82nF	5.6nF	180nF	10nF	390nF	22nF	820nF
	100V	820pF	18nF	1.8nF	47nF	2.7nF	100nF	5.6nF	180nF	12nF	470nF

Available capacitance values:

NPO: E6, E12, E24, E48, E96 (See page 14). Specific values upon request.

X7R: E6, E12, E24 (See page 14). Specific values upon request.

The above table defines the standard products, other components may be built upon request.

Other temperature coefficients, temperature characteristic 2B1 and Bismuth free dielectrics are available: contact your sales representative.

# CER / CNR Series

## Low Inductance Chips Capacitors



### FEATURES

- Low inductance due to their electrodes geometry which allow an increase of the working frequency
- Case sizes: 0306 to 0612
- NPO and X7R dielectrics
- Capacitance range: 1pF to 270nF
- Ag/Pd/Pt, Ni barrier, epoxy terminations available
- RoHS and Non RoHS compliant capacitors available
- Screening in accordance with ESA specifications available

### PHYSICAL CHARACTERISTICS

#### CONSTRUCTION

MLCC capacitors for surface mounting with optional Nickel barrier

#### MARKING (on request)

Capacitance value coded

### ELECTRICAL SPECIFICATIONS

Description	NPO	X7R
Operating temperature	-55°C to +125°C	-55°C to +125°C
Climatic category	55 / 125 / 56	55 / 125 / 56
Rated voltage ( $U_{RC}$ )	16V <sub>DC</sub> to 100V <sub>DC</sub>	16V <sub>DC</sub> to 100V <sub>DC</sub>
Maximum $\Delta C/\Delta C$ over temperature range without DC voltage applied	NA	±15%
Temperature coefficient with or without DC voltage applied	(0 ± 30)ppm/°C	NA
Dielectric withstanding voltage	2.5 $U_{RC}$	2.5 $U_{RC}$
Capacitance	at 1MHz for C ≤ 1,000pF at 1kHz for C > 1,000pF	at 1kHz
Dissipation factor at 25°C	≤ 0.015 (150/C + 7)% at 1MHz for C ≤ 50pF ≤ 0.15% at 1MHz for 50pF < C ≤ 1,000pF ≤ 0.15% at 1kHz for C > 1,000pF	≤ 2.5% at 1kHz
Insulation resistance at 25°C under $U_{RC}$	≥ 100,000 MΩ	≥ 100,000 MΩ for C ≤ 10nF ≥ 1,000 MΩ·μF for C > 10nF
Aging	None	≤ 2.5% per decade hour

### HOW TO ORDER

CER	2	C	560pF	10%	50V
Series/Dielectric	Exxelia size code	Termination	Capacitance	Tolerance	Rated voltage
CER = NPO CNR = X7R	14 = 0306 2 = 0508 12 = 0612	- Ag/Pd/Pt W Ag/Pd/Pt (RoHS) C Ag + Ni + electrolytic Sn/Pb 95/5 CW Ag + Ni + electrolytic Sn (RoHS) D Ag + Ni + electrolytic Sn/Pb 60/40 G Ag + Ni + Au GW Ag + Ni + Au (RoHS) YC Ag + Polymer + Ni + Sn/Pb 95/5 YCW Ag + Polymer + Ni + Sn (RoHS) YD Ag + Polymer + Ni + Sn/Pb 60/40 YG Ag + Polymer + Ni + Au YGW Ag + Polymer + Ni + Au (RoHS)	Capacitance value in clear	NPO: cap. value ≤ 12pF ± 0.25pF cap. value ≤ 8.2pF ± 0.5pF ± 1pF cap. value > 22pF ± 1% cap. value > 12pF ± 2% cap. value > 8.2pF ± 5% ± 10% cap. value > 3.9pF ± 20%  X7R: ± 5% ± 10% ± 20%	16V 25V 50V 100V  Intermediary and higher voltages available on request.

## DIMENSIONS in inches (mm)

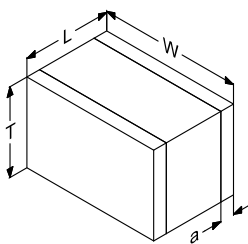

L, W, T for tinned chips [E, EW, H, HW]: +0.02" (+0.5mm)

## STANDARD RATINGS

Size	0306		0508		0612		
Exxelia size code	14		2		12		
Dimensions inches (mm)	L	0.032 ± 0.01 (0.8 ± 0.25)	0.049 ± 0.012 (1.25 ± 0.3)		0.063 ± 0.01 (1.6 ± 0.25)		
	W	0.063 ± 0.008 (1.6 ± 0.2)	0.079 ± 0.012 (2 ± 0.3)		0.126 ± 0.01 (3.2 ± 0.25)		
	a	0.004 min (0.1 min)	0.004 min (0.1 min)		0.012 ± 0.008 (0.3 ± 0.2)		
	T max.	0.04 (1)	0.05 (1.25)		0.063 (1.6)		
Dielectric	NPO	X7R	NPO	X7R	NPO	X7R	
	CER	CNR	CER	CNR	CER	CNR	
Min. Cap. value	1pF	100pF	1pF	100pF	1pF	470pF	
Rated voltage (U <sub>dc</sub> )	16V	820pF	22nF	2.7nF	100nF	10nF	270nF
	25V	680pF	15nF	2.2nF	68nF	8.2nF	180nF
	50V / 63V	470pF	15nF	1.2nF	68nF	4.7nF	120nF
	100V	270pF	4.7nF	820pF	22nF	2.7nF	39nF

Available capacitance values:

NPO: E6, E12, E24, E48, E96 [See page 14]. Specific values upon request.

X7R: E6, E12, E24 [See page 14]. Specific values upon request.

The above table defines the standard products, other components may be built upon request.

# C3N / C4N / C3E / C4E Series

Capacitors Arrays



## FEATURES

- Space saving with multiple capacitors in the same package
- NPO and X7R dielectrics
- Capacitance range: 4.7pF to 3.3nF
- Ag/Pd/Pt, Ni barrier, epoxy terminations available
- RoHS and Non RoHS compliant capacitors available

## PHYSICAL CHARACTERISTICS

MLCC capacitors for surface mounting with optional Nickel barrier

## ELECTRICAL SPECIFICATIONS

Description	NPO	X7R
<b>Operating temperature</b>	-55°C to +125°C	-55°C to +125°C
<b>Climatic category</b>	55 / 125 / 56	55 / 125 / 56
<b>Rated voltage (U<sub>RC</sub>)</b>	25V <sub>DC</sub> to 200V <sub>DC</sub>	25V <sub>DC</sub> to 200V <sub>DC</sub>
<b>Dielectric withstanding voltage at 25°C</b>	2.5 U <sub>RC</sub>	2.5 U <sub>RC</sub>
<b>Capacitance</b>	at 1MHz for C ≤ 1,000pF at 1kHz for C > 1,000pF	at 1MHz for C ≤ 100pF at 1kHz for C > 100pF
<b>Dissipation factor at 25°C</b>	≤ 0.015 (150/C + 7)% at 1MHz for C ≤ 50pF ≤ 0.15% at 1MHz for 50pF < C ≤ 1,000pF	≤ 2.5% at 1kHz for C > 100pF
<b>Insulation resistance at 25°C under U<sub>RC</sub></b>	≥ 50,000MΩ	≥ 20,000MΩ
<b>Aging</b>	None	≤ 2.5% per decade hour

## DIMENSIONS in inches (mm)

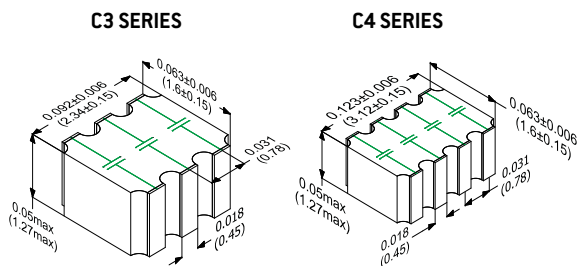

Black lines: mechanical - Green lines: electrical

## STANDARD RATINGS

Dielectric	NPO	X7R	
<b>Dielectric code</b>	E	N	
<b>Min Capacitance value</b>	4.7pF	100pF	
<b>Rated voltage (U<sub>RC</sub>)</b>	25V	680pF	33nF
	50V	390pF	18nF
	100V	270pF	6.8nF
	200V	120pF	3.3nF

Capacitance values of each capacitor of the array are the same. They can be different upon request.

Available capacitance values:

NPO: E6, E12, E24, E48, E96 (See page 14). Specific values upon request.

X7R: E6, E12, E24 (See page 14). Specific values upon request.

The above table defines the standard products, other components may be built upon request.

## HOW TO ORDER

C4	N	C	1.5nF	10%	100V	
Series	Dielectric	Termination	Capacitance	Tolerance	Rated voltage	
<b>C3</b> = 3 capacitors per array <b>C4</b> = 4 capacitors per array	E = NPO N = X7R	-	Capacitance value in clear	NPO: ±0.25pF (cap. value < 15pF) ±0.5pF (cap. value < 10pF) ±1pF (cap. value < 10pF) ±1% (cap. value ≥ 27pF) ±2% (cap. value ≥ 15pF) ±5% (cap. value ≥ 10pF) ±10% (cap. value ≥ 10pF) ±20% (cap. value ≥ 10pF)	25V 50V 100V 200V  Intermediary and higher voltages available on request.	
		W				Ag/Pd/Pt (RoHS)
		C				Ag + Ni + electrolytic Sn/Pb 95/5
		CW				Ag + Ni + electrolytic Sn (RoHS)
		D				Ag + Ni + electrolytic Sn/Pb 60/40
		G				Ag + Ni + Au
		GW				Ag + Ni + Au (RoHS)





### FEATURES

- 4 terminals security capacitors
- Detection of the open circuits
- NPO and X7R dielectrics
- Capacitance range: 470pF to 820nF
- Ag/Pd/Pt, tinned terminations, ribbon connections available
- RoHS and Non RoHS compliant capacitors available

### PHYSICAL CHARACTERISTICS

MLCC capacitors for surface mounting with optional Nickel barrier or ribbon connections

### ELECTRICAL SPECIFICATIONS

Description	NPO	X7R
<b>Operating temperature</b>	-55°C to +125°C	-55°C to +125°C
<b>Climatic category</b>	55 / 125 / 56	55 / 125 / 56
<b>Rated voltage (U<sub>RC</sub>)</b>	40V <sub>DC</sub> to 100V <sub>DC</sub>	40V <sub>DC</sub> to 100V <sub>DC</sub>
<b>Dielectric withstanding voltage at 25°C</b>	2.5 U <sub>RC</sub>	2.5 U <sub>RC</sub>
<b>Capacitance</b>	at 1MHz for C ≤ 1,000pF at 1kHz for C > 1,000pF	at 1MHz for C ≤ 100pF at 1kHz for C > 100pF
<b>Dissipation factor at 25°C</b>	≤0.15% at 1MHz for C ≤ 1,000pF ≤0.15% at 1kHz for C > 1,000pF	≤2.5% at 1kHz
<b>Insulation resistance at 25°C under U<sub>RC</sub></b>	≥ 100,000MΩ	≥ 20,000MΩ for C ≤ 25nF ≥ 500MΩ.μF for C > 25nF
<b>Aging</b>	None	≤ 2.5% per decade hour

### DIMENSIONS in inches (mm)

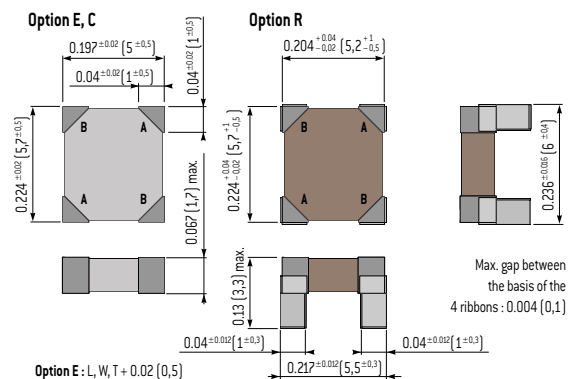

### STANDARD RATINGS

Dielectric	NPO	X7R
<b>Series</b>	1 30 S4	2 30 S4
<b>Min Capacitance value</b>	470pF	3.3nF
<b>Rated voltage (U<sub>RC</sub>)</b>	40V	39nF
	63V	22nF
	100V	10nF
	820nF	560nF
		180nF

Available capacitance values:  
 NPO: E6, E12, E24, E48, E96 (See page 14). Specific values upon request.  
 X7R: E6, E12, E24 (See page 14). Specific values upon request.  
 The above table defines the standard products, other components may be built upon request.

### HOW TO ORDER

130S4	C	M	1.5nF	10%	63V
Series/Dielectric	Termination	Marking	Capacitance	Tolerance	Rated voltage
1 30 S4 = NPO 2 30 S4 = X7R	- Ag/Pd/Pt W Ag/Pd/Pt (RoHS) C Ag + Ni + electrolytic Sn/Pb 95/5 CW Ag + Ni + electrolytic Sn (RoHS) E Ag + Ni + dipped Sn/Pb 60/40 EW Ag + Ni + electrolytic Sn (RoHS) R Solderable ribbons RW Solderable ribbons (RoHS)	For Ag/Pd/Pt, E, C terminations: - = No marking M = Marking  Systematic marking for ribbon terminations	Capacitance value in clear	NPO: ± 1% ± 2% ± 5% ± 10% ± 20%  X7R: ± 10% ± 20%	40V 63V 100V  Intermediary and higher voltages available on request.

# TCE / TCX / TCN / TXR Molded Series

Radial Molded Capacitors

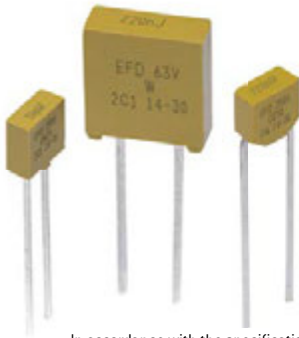

In accordance with the specifications of CECC 30700 and NF C 83132 standards

## FEATURES

- Radial molded capacitors
- NPO, BX, 2C1, X7R dielectrics
- Capacitance range: 0.5pF to 4.7μF
- RoHS and Non RoHS compliant capacitors available

## PHYSICAL CHARACTERISTICS

### CONSTRUCTION

Leaded MLCC capacitors for through-hole mounting:  
Epoxy molded capacitors

### MARKING

Capacitance, tolerance, voltage, dielectric, date code.

## TCN 50/60 R : Enhanced reliability types of TCN 50 A and TCN 60 A.

## ELECTRICAL SPECIFICATIONS

Description	NPO	BX	2C1	X7R
Dielectric code	CE	CX	CN	XR
<b>Operating temperature</b>	-55°C to +125°C			
<b>Climatic category</b>	55 / 125 / 56			
<b>Rated voltage (U<sub>RC</sub>)</b>	25V <sub>DC</sub> to 500V <sub>DC</sub>			
<b>Max. ΔC/°C over temperature range without DC voltage applied</b>	NA	± 15%	± 15%	± 15%
<b>Maximum ΔC/°C over temperature range with rated voltage applied</b>	NA	+15% -25%	+15% -30%	NA
<b>Temperature coefficient with or without DC voltage applied</b>	(0 ± 30)ppm/°C	NA	NA	NA
<b>Dielectric withstanding voltage</b>	2.5 U <sub>RC</sub>			
<b>Capacitance</b>	at 1MHz for C ≤ 1,000pF at 1kHz for C > 1,000pF		at 1MHz for C ≤ 100pF at 1kHz for C > 100pF	
<b>Dissipation factor at 25°C</b>	≤ 0.015 (150/°C + 7)% at 1MHz for C ≤ 50pF ≤ 0.15% at 1MHz for 50pF < C ≤ 1,000pF ≤ 0.15% at 1kHz for C > 1,000pF		≤ 2.5% at 1MHz for C ≤ 100pF ≤ 2.5% at 1kHz for C > 100pF	
<b>Insulation resistance at 25°C</b>	≥ 100,000 MΩ for C ≤ 10nF ≥ 1,000 MΩ.μF for C > 10nF			
<b>Aging</b>	None		≤ 2.5% per decade hour	

## HOW TO ORDER

T	CE	61	A	W	F	6.8nF	10%	25V	B	-
Series	Dielectric	Size	Bismuth	RoHS compliant	Quality level	Capacitance	Tolerance	Rated voltage	Packaging	Reliability level
T = Radial leaded, molded capacitor	CE = NPO CX = BX CN = 2C1 XR = X7R	50 60 61 61N 62 62N 63 64	- = For all models  A = Bismuth free for 50/60 sizes only (tg δ at -55°C ≤ 350.10 <sup>-4</sup> )	- = No RoHS W = RoHS compliant	- = standard quality level  F = Hi-Rel quality: screening in accordance with Exxelia specification	Capacitance value in clear	NPO: cap. value ≤ 12pF ± 0.25pF cap. value ≤ 8.2pF ± 0.5pF ± 1pF cap. value > 22pF ± 1% cap. value > 12pF ± 2% cap. value > 8.2pF ± 5% ± 10% cap. value > 3.9pF ± 20%  Available for BX, 2C1 and X7R: ± 5% ± 10% ± 20%	25V 50V 100V 200V 500V  Intermediary and higher voltages available on request.	- = Exxelia packaging Available for quantity ≥ 500: B = reel	For F parts only. Acc. to Exxelia spec. - T5 T6  See page 15

Radial Molded Capacitors

# TCE / TCX / TCN / TXR Molded Series

## DIMENSIONS in inches (mm)

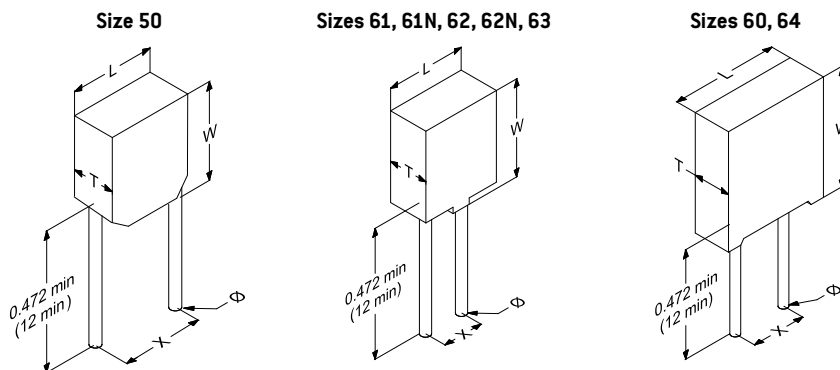

## STANDARD RATINGS

Size	61				61N				62				62N				63				64								
Dimensions inches (mm)	L	0.138 ± 0.02 (3.5 ± 0.5)								0.197 ± 0.02 (5 ± 0.5)								0.295 ± 0.02 (7.5 ± 0.5)								0.394 ± 0.02 (10 ± 0.5)			
	W	0.178 max (4.5 max)								0.237 max (6 max)								0.335 max (8.5 max)								0.434 max (11 max)			
	T	0.098 ± 0.008 (2.5 ± 0.2)								0.098 (2.5 ± 0.2)								0.098 (2.5 ± 0.2)								0.138 (3.5)			
	X	0.1 ± 0.008 (2.54 ± 0.2)				0.2 ± 0.008 (5.08 ± 0.2)				0.1 ± 0.008 (2.54 ± 0.2)				0.2 ± 0.008 (5.08 ± 0.2)				0.2 ± 0.008 (5.08 ± 0.2)				0.2 ± 0.008 (5.08 ± 0.2)							
	Ø ± 10%	0.024 (0.6)								0.024 (0.6)								0.024 (0.6)				0.031 (0.8)							
Dielectric	NPO	BX	2C1	X7R	NPO	BX	2C1	X7R	NPO	BX	2C1	X7R	NPO	BX	2C1	X7R	NPO	BX	2C1	X7R	NPO	BX	2C1	X7R					
Dielectric code	CE	CX	CN	XR	CE	CX	CN	XR	CE	CX	CN	XR	CE	CX	CN	XR	CE	CX	CN	XR	CE	CX	CN	XR					
Min. Cap. value	1pF	27pF				1pF	33pF				4.7pF	330pF				220pF	4.7nF												
Rated voltage (U <sub>RC</sub> )	25V	6.8nF	220nF	220nF	220nF	33nF	820nF	1µF	1µF	68nF	1.8µF	1.8µF	1.8µF	180nF	4.7µF	4.7µF	4.7µF												
	50V	3.3nF	56nF	82nF	100nF	15nF	220nF	390nF	470nF	47nF	1µF	1.2µF	1.2µF	120nF	2.7µF	3.9µF	3.9µF												
	63V	2.7nF	33nF	47nF	68nF	12nF	150nF	220nF	330nF	39nF	560nF	1µF	1µF	100nF	1.8µF	2.7µF	2.7µF												
	100V	1.5nF	12nF	22nF	39nF	6.8nF	56nF	120nF	180nF	18nF	220nF	470nF	680nF	56nF	680nF	1.2µF	1.8µF												
	200V	390pF	3.3nF	5.6nF	10nF	1.8nF	15nF	27nF	47nF	6.8nF	56nF	100nF	180nF	22nF	180nF	330nF	560nF												
	250V	270pF	1.8nF	3.9nF	6.8nF	1.2nF	8.2nF	18nF	27nF	4.7nF	33nF	68nF	120nF	15nF	100nF	220nF	330nF												
	500V	100pF	-	560pF	1.2nF	470pF	-	3.3nF	4.7nF	2.2nF	-	10nF	22nF	6.8nF	-	47nF	82nF												

Size	50				60								
Dimensions inches (mm)	L	0.197 ± 0.02 (5 ± 0.5)								0.295 ± 0.02 (7.5 ± 0.5)			
	W	0.197 ± 0.008 (5 ± 0.2)								0.295 ± 0.008 (7.5 ± 0.2)			
	T	0.098 max. (2.5 max.)								0.098 max. (2.5 max.)			
	X	0.2 ± 0.008 (5.08 ± 0.2)								0.2 ± 0.008 (5.08 ± 0.2)			
	Ø ± 10%	0.024 (0.6)								0.024 (0.6)			
Dielectric	NPO	BX	2C1	X7R	NPO	BX	2C1	X7R	NPO	BX	2C1	X7R	
Dielectric code	CE	CX	CN	XR	CE	CX	CN	XR	CE	CX	CN	XR	
Min. Cap. value	1pF	10pF				4.7pF	330pF						
Rated voltage (U <sub>RC</sub> )	25V	27nF	820nF	820nF	820nF	56nF	1.5µF	1.5µF	1.5µF				
	50V	12nF	220nF	270nF	390nF	39nF	1µF	1µF	1µF				
	63V	10nF	120nF	180nF	270nF	27nF	470nF	1µF	820nF				
	100V	5.6nF	47nF	100nF	150nF	15nF	180nF	390nF	560nF				
	200V	1.5nF	12nF	22nF	39nF	5.6nF	39nF	82nF	150nF				
	250V	1.2nF	6.8nF	15nF	27nF	3.9nF	27nF	56nF	100nF				
	500V	390pF	-	1.8nF	4.7nF	1.5nF	-	8.2nF	15nF				

Available capacitance values:

NPO: E6, E12, E24, E48, E96 (see page 14). Specific values upon request.

X7R: E6, E12, E24 (see page 14). Specific values upon request.

The above table defines the standard products, other components may be built upon request.

# LA Series

## Radial Molded Capacitors



### FEATURES

- Radial molded capacitors
- Temperature coefficients :  $0 \pm 30.10^{-6}$   
 $-750.10^{-6}$   
 $-1500.10^{-6}$
- Capacitance range: 1pF to 680nF
- RoHS and Non RoHS compliant capacitors available

### PHYSICAL CHARACTERISTICS

#### CONSTRUCTION

Leaded MLCC capacitors for through-hole mounting:  
Epoxy molded capacitors

#### MARKING

Capacitance, tolerance, voltage, dielectric, date code.

### ELECTRICAL SPECIFICATIONS

Temperature coefficient	$0 \pm 30.10^{-6}$	$-750.10^{-6}$	$-1500.10^{-6}$
Operating temperature	-55°C to +125°C		
Climatic category	55 / 125 / 56		
Rated voltage (U <sub>RC</sub> )	25V <sub>DC</sub> to 63V <sub>DC</sub>		
Dielectric withstanding voltage	2.5 U <sub>RC</sub>		
Dissipation factor at 1kHz at 25°C	$\leq 10.10^{-4}$	$\leq 100.10^{-4}$	$\leq 250.10^{-4}$
Insulation resistance at 25°C	$\geq 50,000 \text{ M}\Omega$ for C $\leq 1\text{nF}$ $\geq 50 \text{ M}\Omega \cdot \mu\text{F}$ for C > 1nF		

### HOW TO ORDER

LA	1	W	F	10pF	10%	50V	B	-
Series	Size	RoHS compliant	Quality level	Capacitance	Tolerance	Rated voltage	Packaging	Reliability level
LA = Radial leaded, molded capacitor	1 2 3 4 5A 5B 5C	- = No RoHS W = RoHS compliant	- = standard quality level  F = Hi-Rel quality: screening in accordance with Exxelia specification	Capacitance value in clear	$0 \pm 30.10^{-6}$ : cap. value $\leq 10\text{pF}$ $\pm 0.25\text{pF}$  cap. value $\leq 6.8\text{pF}$ $\pm 0.5\text{pF}$ $\pm 1\text{pF}$  cap. value > 22pF $\pm 1\%$  cap. value > 10pF $\pm 2\%$  cap. value > 6.8pF $\pm 5\%$ $\pm 10\%$  cap. value > 3.3pF $\pm 20\%$  Available for $-750.10^{-6}$ and $-1500.10^{-6}$ : $\pm 10\%$ $\pm 20\%$	25V 50V 63V  Intermediary and higher voltages available on request.	- = Exxelia packaging Available for quantity $\geq 500$ : B = reel	For F parts only. Acc. to Exxelia spec. - T5 T6  See page 15

Radial Molded Capacitors

LA Series

DIMENSIONS in inches (mm)

Sizes 1, 2, 3, 4, 5A, 5B, 5C

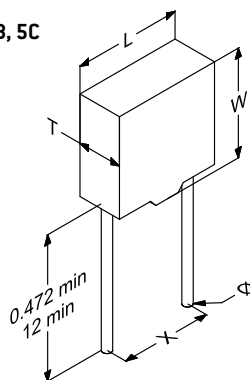

STANDARD RATINGS

Size		1			2			3			4				
Dimensions inches (mm)	L max	0.178 (4.5)			0.197 (5)			0.237 (6)			0.319 (8.1)				
	W max	0.158 (4)			0.178 (4.5)			0.237 (6)			0.319 (8.1)				
	T max	0.107 (2.7)			0.119 (3)			0.119 (3)			0.119 (3)				
	X ± 0.016 (± 0.4)	0.1 (2.54)			0.1 (2.54)			0.2 (5.08)			0.2 (5.08)				
	Ø ± 10%	0.02 (0.5)			0.02 (0.5)			0.02 (0.5)			0.024 (0.6)				
Temperature coefficient	0 ± 30.10 <sup>-6</sup>		-750.10 <sup>-6</sup>	-1500.10 <sup>-6</sup>		0 ± 30.10 <sup>-6</sup>		-750.10 <sup>-6</sup>	-1500.10 <sup>-6</sup>		0 ± 30.10 <sup>-6</sup>		-750.10 <sup>-6</sup>	-1500.10 <sup>-6</sup>	
Rated voltage (U <sub>RC</sub> )	25V	-			-			-			-				
	50V	1pF to 680pF	1nF to 2.2nF	3.3nF to 22nF	1nF to 1.5nF	2.2nF to 6.8nF	10nF to 47nF	2.2nF to 3.3nF	3.3nF to 15nF	22nF to 100nF	3.3nF to 6.8nF	10nF to 47nF	56nF to 680nF		

Size		5A			5B			5C		
Dimensions inches (mm)	L max	0.3 (7.6)			0.3 (7.6)			0.315 (8)		
	W max	0.217 (5.5)			0.217 (5.5)			0.276 (7)		
	T max	0.099 (2.5)			0.197 (5)			0.296 (7.5)		
	X ± 0.016 (± 0.4)	0.2 (5.08)			0.2 (5.08)			0.2 (5.08)		
	Ø ± 10%	0.024 (0.6)			0.024 (0.6)			0.024 (0.6)		
Temperature coefficient	0 ± 30.10 <sup>-6</sup>			0 ± 30.10 <sup>-6</sup>			0 ± 30.10 <sup>-6</sup>			
Rated voltage (U <sub>RC</sub> )	25V	-			-			47nF to 120nF		
	63V	4.7pF to 10nF			6.8nF to 47nF			-		

Available capacitance values:

NP0: E6, E12, E24, E48, E96 (see page 14). Specific values upon request.

X7R: E6, E12, E24 (see page 14). Specific values upon request.

The above table defines the standard products, other components may be built upon request.

STANDARD

# TCE / TCX / TCN / TXR Axial Series

Axial Molded Capacitors

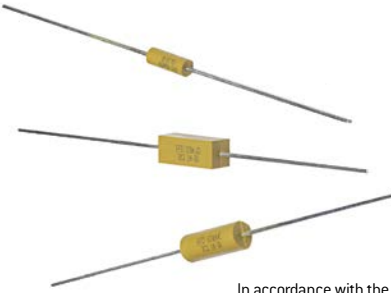

In accordance with the specifications of CECC 30600 and NF C 83131 standards

## FEATURES

- Axial molded capacitors
- NP0, BX, 2C1, X7R dielectrics
- Capacitance range: 1pF to 6.8μF
- RoHS and Non RoHS compliant capacitors available

## PHYSICAL CHARACTERISTICS

### CONSTRUCTION

Leaded MLCC capacitors for through-hole mounting:  
Epoxy molded capacitors

### MARKING

Capacitance, tolerance, voltage, dielectric, date code.

## ELECTRICAL SPECIFICATIONS

Description	NP0	BX	2C1	X7R
Dielectric code	CE	CX	CN	XR
Operating temperature	-55°C to +125°C			
Climatic category	55 / 125 / 56			
Rated voltage (U <sub>RC</sub> )	25V <sub>DC</sub> to 500V <sub>DC</sub>			
Max. ΔC/°C over temperature range without DC voltage applied	NA	± 15%	± 15%	± 15%
Maximum ΔC/°C over temperature range with rated voltage applied	NA	+15% -25%	+15% -30%	NA
Temperature coefficient with or without DC voltage applied	(0 ± 30)ppm/°C	NA	NA	NA
Dielectric withstanding voltage	2.5 U <sub>RC</sub>			
Capacitance	at 1MHz for C ≤ 1,000pF at 1kHz for C > 1,000pF		at 1MHz for C ≤ 100pF at 1kHz for C > 100pF	
Dissipation factor at 25°C	≤ 0.015 (150/°C + 7)% at 1MHz for C ≤ 50pF ≤ 0.15% at 1MHz for 50pF < C ≤ 1,000pF ≤ 0.15% at 1kHz for C > 1,000pF		≤ 2.5% at 1MHz for C ≤ 100pF ≤ 2.5% at 1kHz for C > 100pF	
Insulation resistance at 25°C	≥ 100,000 MΩ for C ≤ 10nF ≥ 1,000 MΩ.μF for C > 10nF			
Aging	None		≤ 2.5% per decade hour	

## HOW TO ORDER

T	CE	52	W	F	3.3nF	10%	25V	B
Series	Dielectric	Size	RoHS compliant	Quality level	Capacitance	Tolerance	Rated voltage	Packaging
T = Axial leaded, molded capacitor	CE = NP0 CX = BX CN = 2C1 XR = X7R	52 52R 53 53R 54 54R 55 55R 56R	- = No RoHS W = RoHS compliant	- = standard quality level  F = Hi-Rel quality: screening in accordance with Exxelia specification	Capacitance value in clear	NP0: cap. value ≤ 12pF ± 0.25pF cap. value ≤ 8.2pF ± 0.5pF ± 1pF cap. value > 22pF ± 1% cap. value > 12pF ± 2% cap. value > 8.2pF ± 5% ± 10% cap. value > 3.9pF ± 20%  Available for BX, 2C1 and X7R: ± 5% ± 10% ± 20%	25V 50V 63V 100V 200V 250V 500V  Intermediary and higher voltages available on request.	- = Exxelia packaging Available for quantity ≥ 500: B = reel

Axial Molded Capacitors

# TCE / TCX / TCN / TXR Axial Series

## DIMENSIONS in inches (mm)

Sizes 52R, 53R, 54R, 55R, 56R

Sizes 52, 53, 54

Size 55

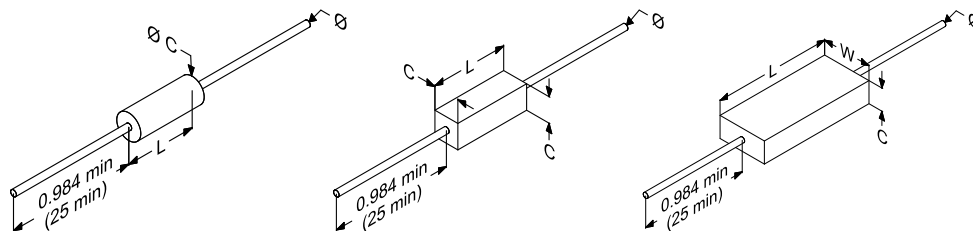

## STANDARD RATINGS

Size	52				52R				53				53R				
Dimensions inches (mm)	L	0.217 max (5.5 max)				0.167 max (4.3 max)				0.296 max (7.5 max)				0.26 max (6.6 max)			
	C	0.099 max (2.5 max)				-				0.154 max (3.9 max)				-			
	W	-				-				-				-			
	Ø ± 10%	0.024 (0.6)				-				0.024 (0.6)				-			
<b>Dielectric</b>	NPO	BX	2C1	X7R	NPO	BX	2C1	X7R	NPO	BX	2C1	X7R	NPO	BX	2C1	X7R	
<b>Dielectric code</b>	CE	CX	CN	XR	CE	CX	CN	XR	CE	CX	CN	XR	CE	CX	CN	XR	
<b>Min. Cap. value</b>	1pF	10pF				1pF				10pF				1pF			
Rated voltage (U <sub>RC</sub> )	25V	3.3nF	82nF	100nF	120nF	10nF	220nF	220nF	220nF	10nF	220nF	220nF	220nF	10nF	220nF	220nF	220nF
	50V	1.5nF	27nF	39nF	47nF	6.8nF	56nF	82nF	100nF	6.8nF	56nF	82nF	100nF	6.8nF	56nF	82nF	100nF
	63V	1.2nF	15nF	22nF	33nF	6.8nF	33nF	47nF	68nF	6.8nF	33nF	47nF	68nF	6.8nF	33nF	47nF	68nF
	100V	680pF	6.8nF	12nF	18nF	2.2nF	15nF	27nF	39nF	2.2nF	15nF	27nF	39nF	2.2nF	15nF	27nF	39nF
	200V	180pF	1.5nF	2.7nF	4.7nF	560pF	2.7nF	4.7nF	8.2nF	560pF	2.7nF	4.7nF	8.2nF	560pF	2.7nF	4.7nF	8.2nF
	250V	120pF	-	1.5nF	2.7nF	390pF	-	3.3nF	5.6nF	390pF	-	3.3nF	5.6nF	390pF	-	3.3nF	5.6nF
	500V	39pF	-	-	-	120pF	-	-	-	120pF	-	-	-	120pF	-	-	-

Size	54				54R				55								
Dimensions inches (mm)	L	0.394 max (10 max)				0.433 ± 0.02 (11 ± 0.5)				0.433 ± 0.02 (11 ± 0.5)							
	C	0.154 max (3.9 max)				-				0.217 ± 0.02 (5.5 ± 0.5)							
	W	-				-				0.315 ± 0.02 (8 ± 0.5)							
	Ø ± 10%	0.024 (0.6)				-				0.024 (0.6)							
<b>Dielectric</b>	NPO	BX	2C1	X7R	NPO	BX	2C1	X7R	NPO	BX	2C1	X7R	NPO	BX	2C1	X7R	
<b>Dielectric code</b>	CE	CX	CN	XR	CE	CX	CN	XR	CE	CX	CN	XR	CE	CX	CN	XR	
<b>Min. Cap. value</b>	4.7pF	27pF				10pF				68pF							
Rated voltage (U <sub>RC</sub> )	25V	27nF	820nF	1µF	1µF	150nF	3.9µF	3.9µF	3.9µF	27nF	820nF	1µF	1µF	150nF	3.9µF	3.9µF	3.9µF
	50V	15nF	270nF	330nF	390nF	100nF	2.2µF	2.7µF	2.7µF	15nF	270nF	330nF	390nF	100nF	2.2µF	2.7µF	2.7µF
	63V	12nF	180nF	270nF	330nF	82nF	1.2µF	1.8µF	2.2µF	12nF	180nF	270nF	330nF	82nF	1.2µF	1.8µF	2.2µF
	100V	5.6nF	68nF	100nF	180nF	47nF	560nF	1µF	1.5µF	5.6nF	68nF	100nF	180nF	47nF	560nF	1µF	1.5µF
	200V	1.8nF	15nF	22nF	39nF	18nF	120nF	220nF	390nF	1.8nF	15nF	22nF	39nF	18nF	120nF	220nF	390nF
	250V	1.2nF	8.2nF	12nF	22nF	12nF	68nF	150nF	220nF	1.2nF	8.2nF	12nF	22nF	12nF	68nF	150nF	220nF
	500V	470pF	-	2.7nF	4.7nF	4.7nF	-	27nF	47nF	470pF	-	2.7nF	4.7nF	4.7nF	-	27nF	47nF

Available capacitance values:

NPO: E6, E12, E24, E48, E96 (see page 14). Specific values upon request.

X7R: E6, E12, E24 (see page 14). Specific values upon request.

The above table defines the standard products, other components may be built upon request.

STANDARD

# TCE / TCX / TCN / TXR Conformal Coated Series

Radial Dipped Capacitors



In accordance with the specifications of  
CECC 30700 and NF C 83132 standards

## FEATURES

- Radial conformal coated capacitors
- NPO, BX, 2C1, X7R dielectrics
- Capacitance range: 1pF to 6.8μF
- RoHS and Non RoHS compliant capacitors available

## PHYSICAL CHARACTERISTICS

### CONSTRUCTION

Leaded MLCC capacitors for through-hole mounting;  
Epoxy molded capacitors

### MARKING

Capacitance, tolerance, voltage, dielectric, date code.

## ELECTRICAL SPECIFICATIONS

Description	NPO	BX	2C1	X7R
<b>Dielectric code</b>	CE	CX	CN	XR
<b>Operating temperature</b>	-55°C to +125°C			
<b>Climatic category</b>	55 / 125 / 56			
<b>Rated voltage (U<sub>RC</sub>)</b>	25V <sub>DC</sub> to 500V <sub>DC</sub>			
<b>Max. ΔC/°C over temperature range without DC voltage applied</b>	NA	± 15%	± 15%	± 15%
<b>Maximum ΔC/°C over temperature range with rated voltage applied</b>	NA	+15% -25%	+15% -30%	NA
<b>Temperature coefficient with or without DC voltage applied</b>	(0 ± 30)ppm/°C	NA	NA	NA
<b>Dielectric withstanding voltage</b>	2.5 U <sub>RC</sub>			
<b>Capacitance</b>	at 1MHz for C ≤ 1,000pF at 1kHz for C > 1,000pF		at 1MHz for C ≤ 100pF at 1kHz for C > 100pF	
<b>Dissipation factor at 25°C</b>	≤ 0.015 (150/°C + 7)% at 1MHz for C ≤ 50pF ≤ 0.15% at 1MHz for 50pF < C ≤ 1,000pF ≤ 0.15% at 1kHz for C > 1,000pF		≤ 2.5% at 1MHz for C ≤ 100pF ≤ 2.5% at 1kHz for C > 100pF	
<b>Insulation resistance at 25°C</b>	≥ 100,000 MΩ for C ≤ 10nF ≥ 1,000 MΩ.μF for C > 10nF			
<b>Aging</b>	None		≤ 2.5% per decade hour	

## HOW TO ORDER

T	CE	77-1	W	F	2.7nF	10%	50V	B
Series	Dielectric	Size	RoHS compliant	Quality level	Capacitance	Tolerance	Rated voltage	Packaging
T = Radial leaded, conformal coated capacitor	CE = NPO CX = BX CN = 2C1 XR = X7R	77-1 77-5 78-1 78-5 79-5 80-5 76-5	- = No RoHS W = RoHS compliant	- = standard quality level  F = Hi-Rel quality: screening in accordance with Exxelia specification	Capacitance value in clear	NPO: cap. value ≤ 12pF ± 0.25pF cap. value ≤ 8.2pF ± 0.5pF ± 1pF cap. value > 22pF ± 1% cap. value > 12pF ± 2% cap. value > 8.2pF ± 5% ± 10% cap. value > 3.9pF ± 20%  Available for BX, 2C1 and X7R: ± 5% ± 10% ± 20%	25V 50V 63V 100V 200V 250V 500V  Intermediary and higher voltages available on request.	- = Exxelia packaging Available for quantity. ≥ 500: B = reel



Radial Dipped Capacitors

# TCE / TCX / TCN / TXR Conformal Coated Series

## DIMENSIONS in inches (mm)

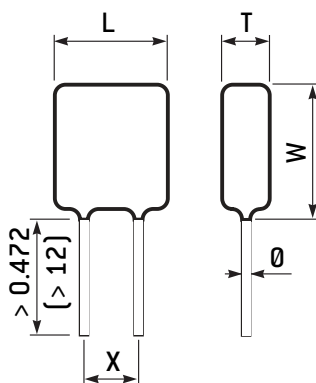

## STANDARD RATINGS

Size	77-1				77-5				78-1		78-5						
Dimensions inches (mm)	L max.	0.150 (3.8)				0.150 (3.8)				0.197 (5)		0.197 (5)					
	W max.	0.229 (5.8)				0.209 (5.3)				0.276 (7)		0.256 (6.5)					
	T max.	0.099 (2.5)				0.099 (2.5)				0.123 (3.1)		0.123 (3.1)					
	X ± 0.008 (± 0.2)	0.2 (5.08)				0.1 (2.54)				0.2 (5.08)		0.1 (2.54)					
	Ø ± 10%	0.024 (0.6)				0.024 (0.6)				0.024 (0.6)		0.024 (0.6)					
Dielectric	NPO		BX		2C1		X7R		NPO		BX		2C1		X7R		
Dielectric code	CE		CX		CN		XR		CE		CX		CN		XR		
Min. Cap. value	1pF				22pF				1pF				22pF				
Rated voltage (U <sub>DC</sub> )	25V	5.6nF		150nF		180nF		180nF		33nF		820nF		1µF		1µF	
	50V	2.7nF		39nF		56nF		82nF		15nF		220nF		390nF		470nF	
	63V	2.2nF		27nF		39nF		56nF		12nF		150nF		220nF		330nF	
	100V	1.2nF		10nF		18nF		33nF		6.8nF		56nF		120nF		180nF	
	200V	390pF		2.2nF		3.9nF		8.2nF		2.2nF		12nF		27nF		47nF	
	250V	220pF		1.2nF		2.8nF		4.7nF		1.2nF		8.2nF		18nF		33nF	
	500V	82pF						820pF		470pF				2.7nF		4.7nF	

Size	79-5				80-5				76-5								
Dimensions inches (mm)	L max.	0.299 (7.6)				0.398 (10.1)				0.5 (12.7)							
	W max.	0.378 (9.6)				0.477 (12.1)				0.56 (14.2)							
	T max.	0.15 (3.8)				0.15 (3.8)				0.197** (5)**							
	X ± 0.008 (± 0.2)	0.2 (5.08)				0.2 (5.08)				0.4* (10.16)*							
	Ø ± 10%	0.024 (0.6)				0.024 (0.6)				0.024 (0.6)							
Dielectric	NPO		BX		2C1		X7R		NPO		BX		2C1		X7R		
Dielectric code	CE		CX		CN		XR		CE		CX		CN		XR		
Min. Cap. value	1nF				4.7nF				3.9nF				12nF				
Rated voltage (U <sub>DC</sub> )	25V	82nF		2.2µF		2.2µF		2.2µF		150nF		3.9µF		3.9µF		3.9µF	
	50V	56nF		1.2µF		1.5µF		1.5µF		100nF		2.7µF		2.7µF		2.7µF	
	63V	47nF		820nF		1µF		1.2µF		100nF		1.5µF		2.2µF		2.2µF	
	100V	27nF		270nF		560nF		820nF		56nF		560nF		1.2µF		1.2µF	
	200V	10nF		82nF		150nF		220nF		27nF		180nF		330nF		390nF	
	250V	6.8nF		47nF		100nF		150nF		15nF		100nF		220nF		220nF	
	500V	3.3nF		6.8nF		18nF		33nF		6.8nF		15nF		39nF		56nF	

\* X = 0.2" [5.08mm] for Cr ≤ 1µF - 50V and Cr ≤ 680nF - 100V  
 \*\* T max = 0.273" [6mm] for Cr ≥ 3.3µF - 50V

Available capacitance values:  
 NPO: E6, E12, E24, E48, E96 (see page 14). Specific values upon request.  
 X7R: E6, E12, E24 (see page 14). Specific values upon request.  
 The above table defines the standard products, other components may be built upon request.

# Non Magnetic Conformal Coated Series

Radial Dipped Capacitors



## FEATURES

- Case sizes: 1812 to 2220
- NPO and X7R dielectrics
- Capacitance range: 180pF to 1 $\mu$ F
- RoHS compliant capacitors

## PHYSICAL CHARACTERISTICS

MLCC capacitors with:

- Radial leads for through-hole mounting.

## ELECTRICAL SPECIFICATIONS

Description	NPO dielectric	X7R dielectric
Dielectric code	N	X
CECC class	1B / CG	2R1
EIA class	Class I	Class II
Temperature range	-55°C to +125°C	-55°C to +125°C
Temperature coefficient	(0 $\pm$ 30) ppm/°C	NA
Maximum $\Delta$ C/°C over temperature range without DC voltage applied	NA	$\pm$ 15%
Rated voltage (U <sub>R</sub> )	100V <sub>DC</sub> to 500V <sub>DC</sub>	63V <sub>DC</sub> to 500V <sub>DC</sub>
Dielectric withstanding voltage	250% rated voltage	250% rated voltage
Insulation resistance (I <sub>R</sub> ) at 25°C under U <sub>R</sub>	100G $\Omega$ or 1,000 $\Omega$ .F whichever is less	100G $\Omega$ or 1,000 $\Omega$ .F whichever is less
Aging	None	$\leq$ 2.5% per decade hour

## HOW TO ORDER

630	S43	X	394	K	R	E
Rated voltage	Exxelia size code	Dielectric code	Capacitance	Tolerance	Termination	Packaging
<b>630</b> = 63V <b>101</b> = 100V <b>201</b> = 200V <b>501</b> = 500V	<b>S43</b> = 1812 <b>S47</b> = 2220	<b>N</b> = NPO <b>X</b> = X7R	Capacitance value in code. 1 <sup>st</sup> two digits represent significant figures; last digit specifies the number of zeros to follow.  Examples: <b>101</b> = 100pF <b>472</b> = 4.7nF <b>683</b> = 68nF <b>564</b> = 0.56 $\mu$ F <b>105</b> = 1 $\mu$ F	<b>NPO</b> : <b>F</b> = $\pm$ 1% <b>G</b> = $\pm$ 2% <b>J</b> = $\pm$ 5% <b>K</b> = $\pm$ 10% <b>M</b> = $\pm$ 20%  <b>X7R</b> : <b>K</b> = $\pm$ 10% <b>M</b> = $\pm$ 20%	<b>R</b> = Radial two wires	- = Bulk  <b>E</b> = tape & reel

## DIMENSIONS in inches (mm)

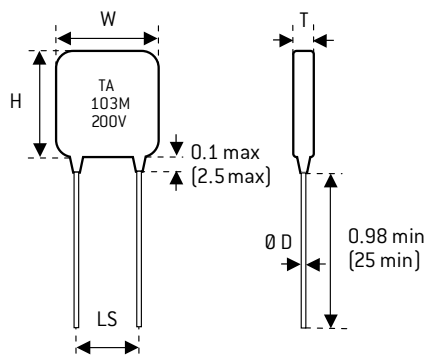

## STANDARD RATINGS

Size		1812		2220	
Exxelia size code		S43		S47	
Dimensions inches (mm)	W	0.28 max. [7.1 max.]		0.327 max. [8.3 max.]	
	H	0.26 max. [6.6 max.]		0.335 max. [8.5 max.]	
	LS	0.2 ± 0.02 [5.08 ± 0.5]		0.2 ± 0.02 [5.08 ± 0.5]	
	Ø ± 10%	0.024 [0.6]		0.024 [0.6]	
	T max.	0.146 [3.7]		0.146 [3.7]	
Dielectric		NPO	X7R	NPO	X7R
		N	X	N	X
Rated voltage (U <sub>RC</sub> )	63V	-	150nF to 1µF	-	330nF to 1µF
	100V	1.8nF to 5.6nF	-	6.8nF to 10nF	-
	200V	180pF to 5.6nF	2.7nF to 100nF	680pF to 10nF	6.8nF to 220nF
	500V	180pF to 2.2nF	2.7nF to 47nF	680pF to 4.7nF	6.8nF to 100nF

Available capacitance values:

E6, E12 (see page 14). Specific values upon request.

Note: some capacitance values in these tables may not be proposed for small quantities. Please, contact us for confirmation.

For exact values regarding the thickness, please consult us.

# CK Series

## Radial Molded Capacitors



In accordance with MIL C 11015 D standards

### FEATURES

- Radial molded capacitors
- BX dielectric
- Capacitance range: 10pF to 1μF
- RoHS and Non RoHS compliant capacitors available

### PHYSICAL CHARACTERISTICS

#### CONSTRUCTION

Leaded MLCC capacitors for through-hole mounting:  
Epoxy molded capacitors

#### MARKING

Capacitance, tolerance, voltage, dielectric, date code.

**CKR 05/06 : on request, High reliability types.**

### ELECTRICAL SPECIFICATIONS

Description	BX
Operating temperature	-55°C to +125°C
Climatic category	55 / 125 / 56
Rated voltage (U <sub>RC</sub> )	25V <sub>DC</sub> to 250V <sub>DC</sub>
Max. ΔC/C over temperature range without DC voltage applied	± 15%
Maximum ΔC/C over temperature range with rated voltage applied	+15% -25%
Dielectric withstanding voltage	2.5 U <sub>RC</sub>
Capacitance	at 1MHz for C ≤ 100pF at 1kHz for C > 100pF
Dissipation factor at 25°C	≤2.5% at 1MHz for C ≤ 100pF ≤2.5% at 1kHz for C > 100pF
Insulation resistance at 25°C	≥ 100,000 MΩ for C ≤ 10nF ≥ 1,000 MΩ.μF for C > 10nF
Aging	≤ 2.5% per decade hour

### DIMENSIONS in inches (mm)

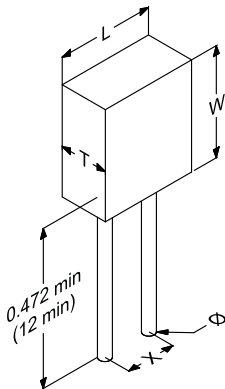

Available capacitance values:  
BX: E6, E12, E24 (see page 14). Specific values upon request.  
The above table defines the standard products, other components may be built upon request.

### STANDARD RATINGS

Size	05	06	
Dimensions inches (mm)	L	0.189 ± 0.008 (4.8 ± 0.2)	0.291 ± 0.008 (7.4 ± 0.2)
	W	0.189 ± 0.008 (4.8 ± 0.2)	0.291 ± 0.008 (7.4 ± 0.2)
	T	0.091 ± 0.008 (2.3 ± 0.2)	0.091 ± 0.008 (2.3 ± 0.2)
	X	0.2 ± 0.008 (5.08 ± 0.2)	0.2 ± 0.008 (5.08 ± 0.2)
	0 ± 10%	0.024 (0.6)	0.024 (0.6)
Min. Cap. value	10pF	330pF	
Rated voltage (U <sub>RC</sub> )	25V	820nF	1.5μF
	50V	220nF	1μF
	63V	120nF	470nF
	100V	47nF	180nF
	200V	12nF	39nF
	250V	6.8nF	27nF

### HOW TO ORDER

CK	05	W	F	820nF	10%	25V	B	-
Series	Size	RoHS compliant	Quality level	Capacitance	Tolerance	Rated voltage	Packaging	Reliability level
CK = Radial leaded, molded capacitor	05 06	- = No RoHS W = RoHS compliant	- = standard quality level F = Hi-Rel quality: screening in accordance with Exxelia specification	Capacitance value in clear	± 10% ± 20%	25V 100V 50V 200V 63V 250V  Intermediary and higher voltages available on request	- = Exxelia packaging Available for quantity ≥ 500: B = reel	For F parts only. Acc. to Exxelia spec. - T5 T6  See page 15

# HIGH VOLTAGE

GENERAL INFORMATION ..... 46

**C SERIES**  
High Voltage Chips Capacitors ..... 51

**TCL / TCK SERIES**  
High Voltage Molded & Varnished Leaded Caps ..... 54

**TCF SERIES**  
High Voltage Conformal Coated Leaded Caps ..... 57

**TKD SERIES**  
High Voltage Conformal Coated Leaded Caps ..... 60

**CS SERIES**  
High Voltage Stacked Capacitors ..... 62

**VM SERIES**  
Voltage Multipliers ..... 65

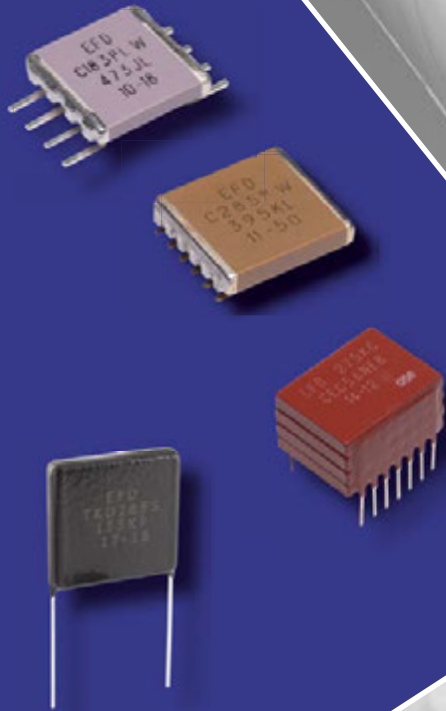

# General Information

High voltage multilayer ceramic capacitors designed by EXXELIA are adapted to applications in electronics such as high voltage power supplies and high voltage multiplier circuits. Their multilayer construction offers significant size and space saving advantages. They are available in class 1 (NPO), class 2 (X7R) and C4xx (-2,200 ppm/°C) dielectrics versions complying with the main requirements of applicable standards. They are suited for use in commercial, industrial and High-Rel military and space circuits.

As standard products can't meet all the specificities of all applications, special applications may require specific features (higher voltage, burn-in, dimensions, coating, leading, marking...) not described in this catalogue. Based on our state-of-the-art technologies and our expertise, our Engineers may study at your request all special components to meet your application.

Please, consult us for more information.

### NPO, X7R, C4xx: SELF-RESONANCE FREQUENCY VS CAPACITANCE

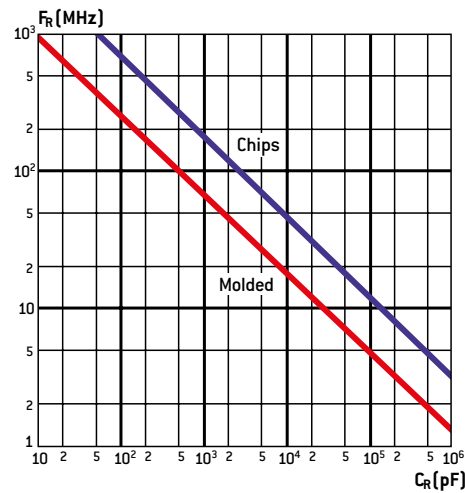

### NPO/COG DIELECTRICS (CLASS 1)

Made of titanium oxide and other various selected oxides, they feature unique stability of all parameters under such constraints as operating time, temperature, voltage applied. For example, the quality factor remains very high over an extremely wide frequency range. As example, loss angle tangent value at 1 MHz is typically in the order of 3.10<sup>-4</sup>. These characteristics make them compatible with steep-edge impulse mode without noticeable temperature rise. The different parameters and related variations are illustrated in figures below:

### NPO: RELATIVE CAPACITANCE CHANGE VS TEMPERATURE

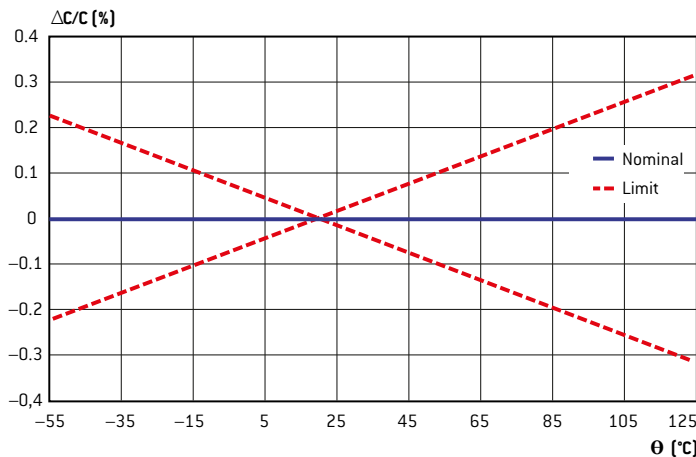

### NPO: IMPEDANCE VS FREQUENCY

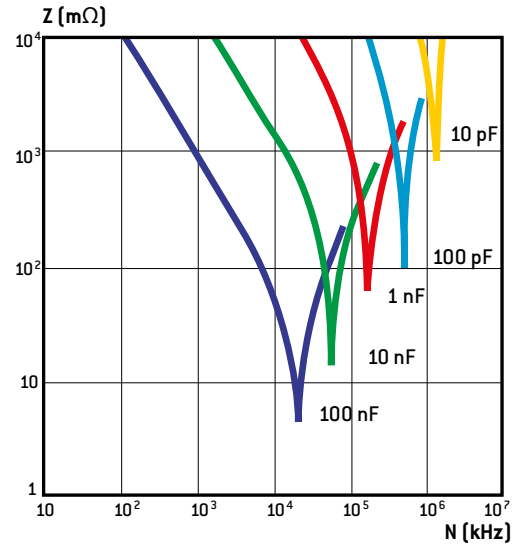

### NPO: LOSS TANGENT VS TEMPERATURE

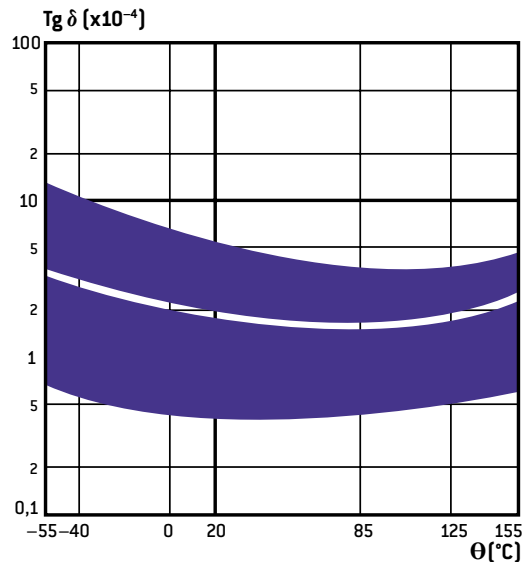

### NPO: INSULATION RESISTANCE VS TEMPERATURE

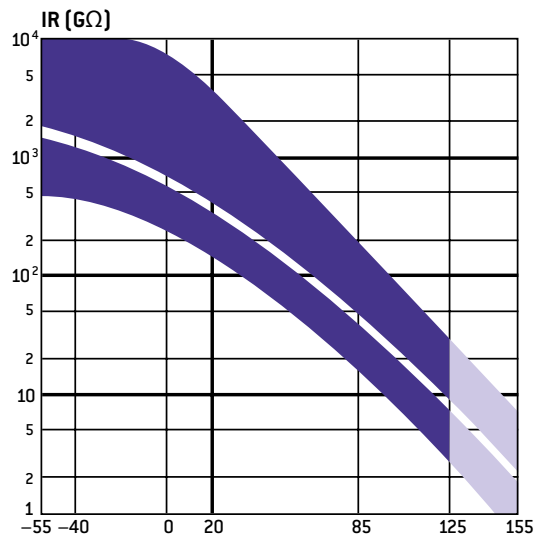

# General Information

## X7R DIELECTRICS (CLASS 2)

They are mainly made of barium titanate modified by various oxides to achieve the electrical properties required. A specific ceramic dielectric is used to achieve an excellent dielectric strength. High dielectric constant enables to achieve high capacitance values.

For optimum use, the specific properties of barium titanate in function of the different parameters must be taken into account.

See the variations illustrated in figures below:

### CHANGE VS PERCENTAGE OF RATED VOLTAGE APPLIED

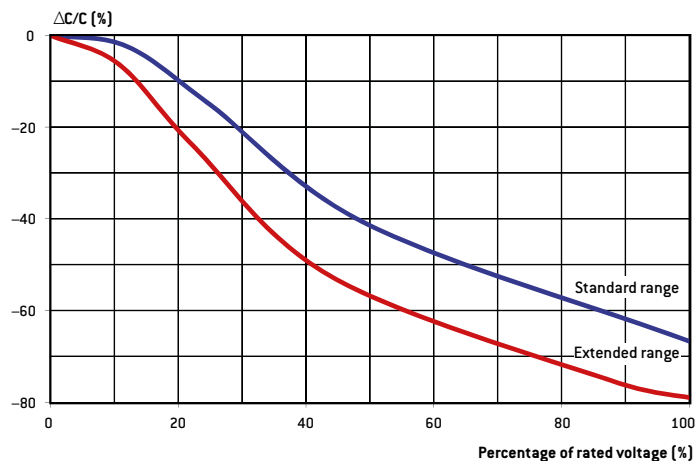

### X7R: CAPACITANCE CHANGE VS TEMPERATURE

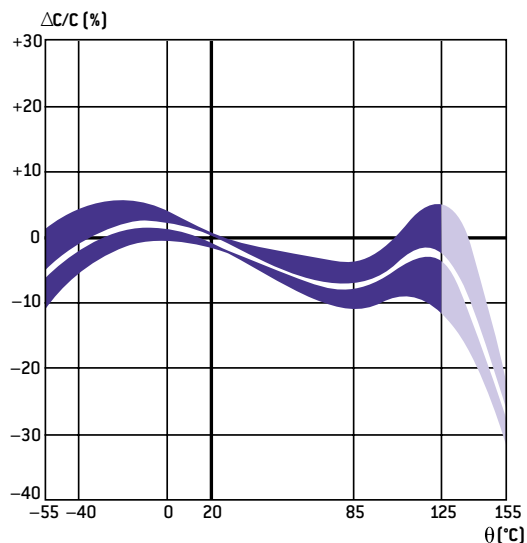

### X7R: CAPACITANCE CHANGE VS FREQUENCY

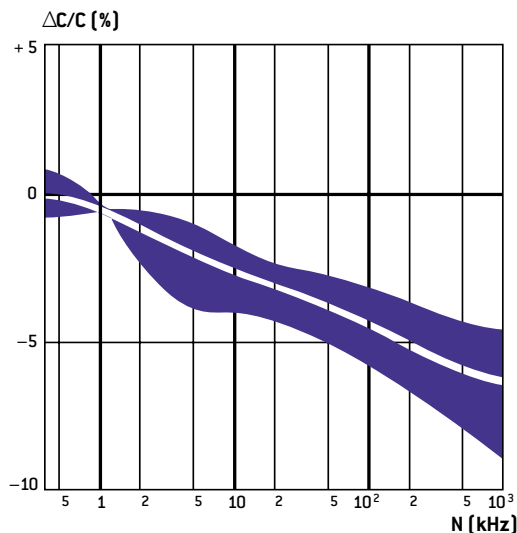

### X7R: INSULATION RESISTANCE VS TEMPERATURE

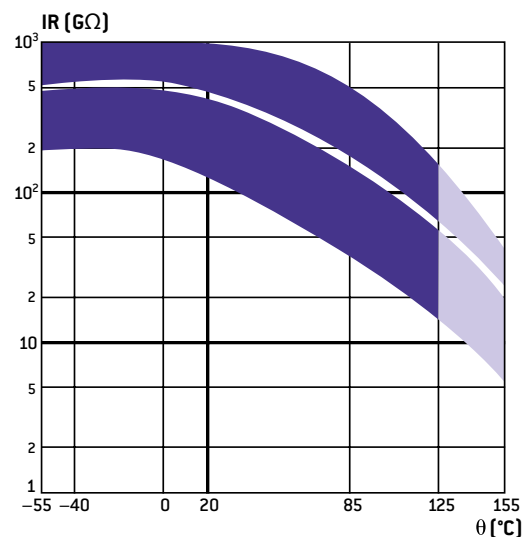

HIGH VOLTAGE

# General Information

X7R: LOSS TANGENT CHANGE VS TEMPERATURE

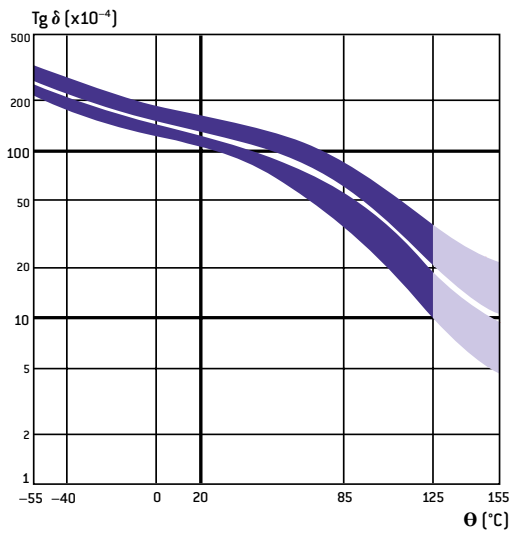

X7R: MAXIMUM ADMISSIBLE CURRENT VS FREQUENCY

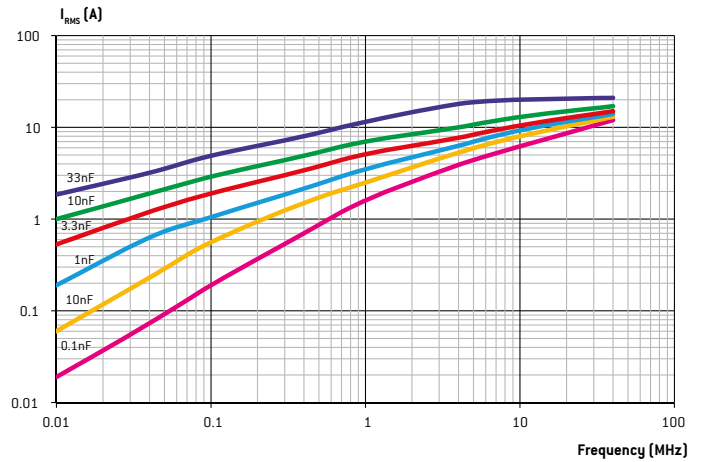

These typical curves are examples of admissible currents for one family of chip capacitors (size 3333). For other curves and products or for further information, please contact us.

Note: for the calculations, we have considered that the terminations are directly connected to an infinite heat sink. In other words, the thermal resistance of the circuit itself which depends on its type and design has not been taken into account. Moreover, the ambient temperature taken is 25°C.

X7R: LOSS TANGENT CHANGE VS FREQUENCY

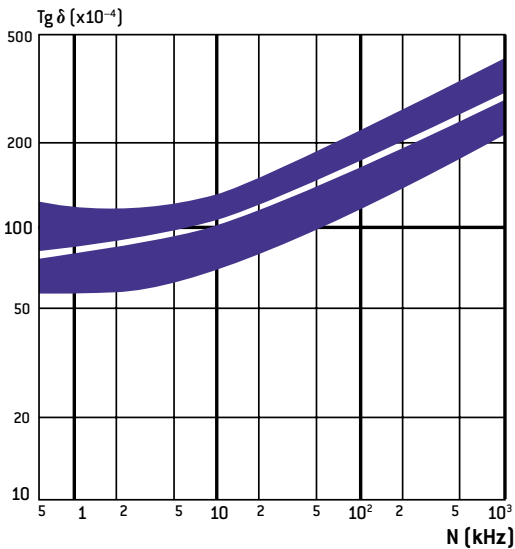

X7R: ESR VS FREQUENCY

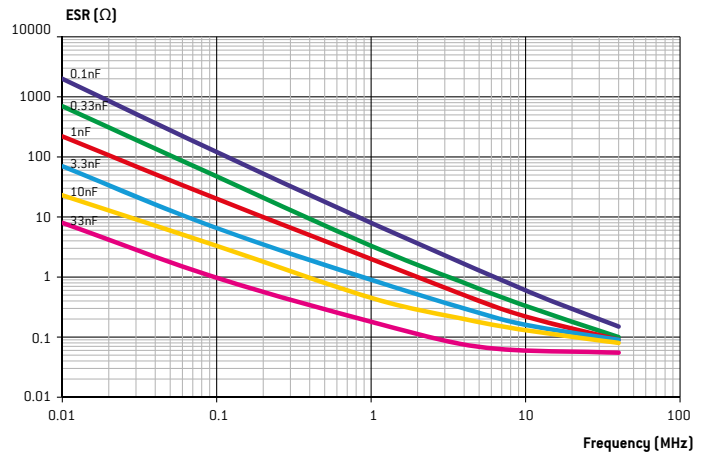

The ESR (Equivalent Serial Resistance) typical curves are given, here for SMD (chip) capacitors. Regarding the curves for the leaded capacitors, they are rather the same. Indeed, due to the resistivity of the raw material used and the wire diameters, the resistance of the wires is much lower than the ESR of the chips. So, in a first approach, their influence can be considered as negligible.



# General Information

## C4xx DIELECTRIC

This ceramic is a negative temperature coefficient dielectric (-2,200 ppm/°C). Its advantage is that it combines the high dielectric constant of an X7R dielectric with the stability of an NPO dielectric. As the C4xx ceramic features low dissipation factor it is recommended for AC line filtering from 110 Vrms to 230 Vrms, 20 to 400 Hz, for high power RF at high voltage up to 5,000 V and for pulse applications.

### C4xx: TEMPERATURE COEFFICIENT

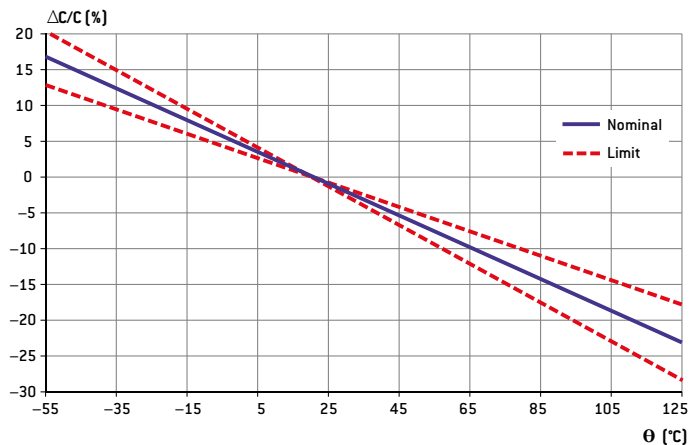

### COMPARISON OF CAPACITANCE VALUE UNDER RATED VOLTAGE AT 125°C

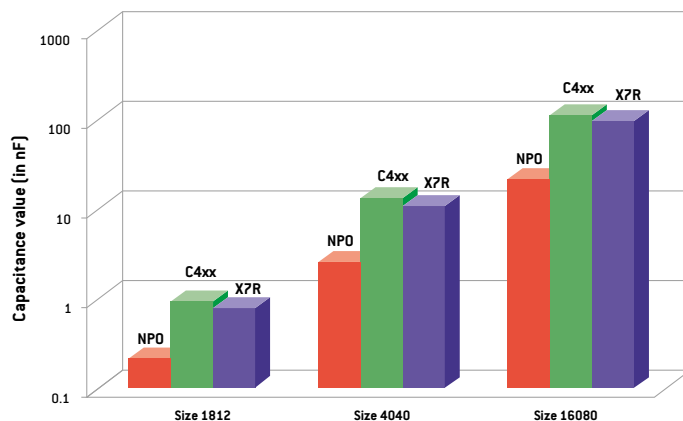

HIGH VOLTAGE

### C4xx: VOLTAGE COEFFICIENT

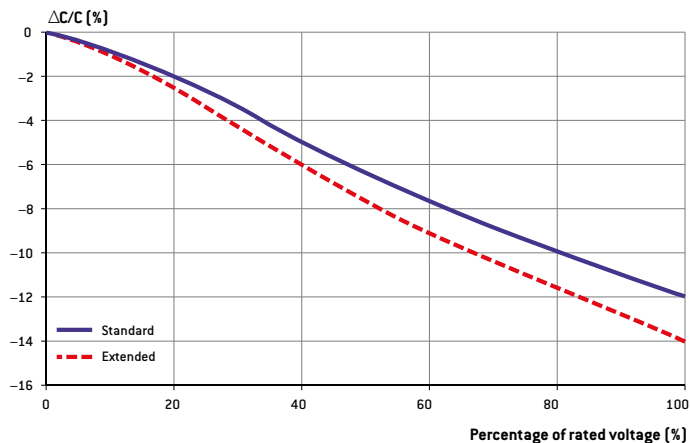

### COMPARISON OF SELF-HEATING AT 400 Hz BETWEEN C4xx AND X7R DIELECTRICS

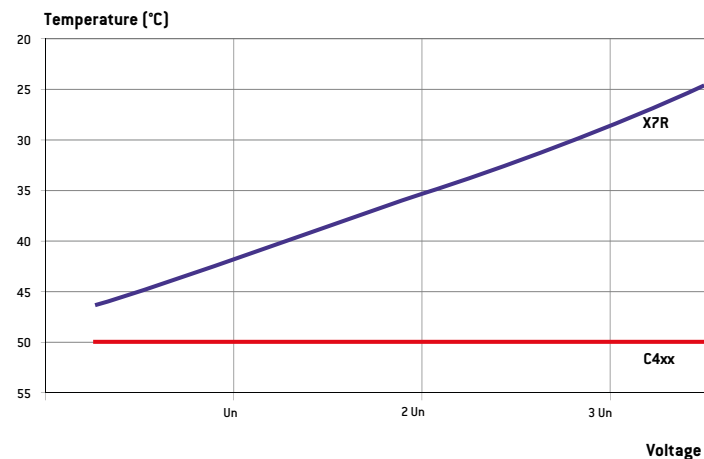

# General Information

## RECOMMENDED FOOTPRINTS

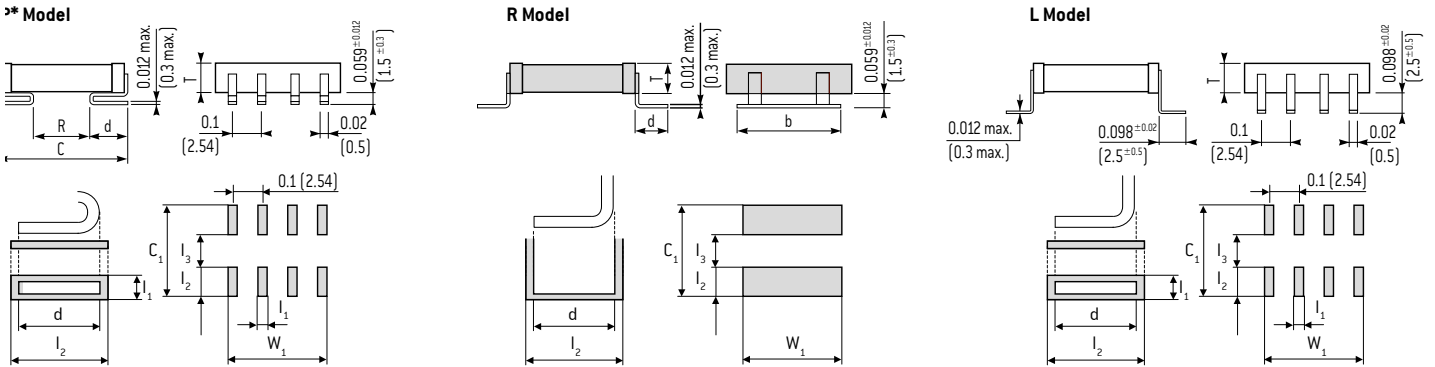

## DIMENSIONS in inches (mm)

Exxelia size code	Lead shape	C max inches (mm)	Leads per side	d inches (mm)	b inches (mm)	C <sub>1</sub> inches (mm)	W <sub>1</sub> inches (mm)	I <sub>1</sub> inches (mm)	I <sub>2</sub> inches (mm)	I <sub>3</sub> inches (mm)
90	P*	0.228 [5.8]	2	0.06 ± 0.012 [1.5 ± 0.3]	-	0.268 [6.8]	0.147 [3.74]	0.047 [1.2]	0.108 [2.75]	0.098 [2.5]
	L	0.394 [10]	2	0.098 ± 0.02 [2.5 ± 0.5]	-	0.433 [11]	0.147 [3.74]	0.047 [1.2]	0.152 [3.85]	0.130 [3.3]
	R	0.386 [9.8]	1	0.087 ± 0.008 [2.2 ± 0.2]	0.197 ± 0.02 [5 ± 0.5]	0.425 [10.8]	0.244 [6.2]	-	0.148 [3.75]	0.130 [3.3]
80	P*	0.276 [7]	2	0.06 ± 0.012 [1.5 ± 0.3]	-	0.315 [8]	0.147 [3.74]	0.047 [1.2]	0.108 [2.75]	0.098 [2.5]
	L	0.480 [12.2]	2	0.098 ± 0.02 [2.5 ± 0.5]	-	0.520 [13.2]	0.147 [3.74]	0.047 [1.2]	0.171 [4.35]	0.177 [4.5]
	R	0.433 [11]	1	0.087 ± 0.008 [2.2 ± 0.2]	0.197 ± 0.02 [5 ± 0.5]	0.472 [12]	0.244 [6.2]	-	0.148 [3.75]	0.177 [4.5]
91	P*	0.276 [7]	2	0.06 ± 0.012 [1.5 ± 0.3]	-	0.315 [8]	0.147 [3.74]	0.047 [1.2]	0.108 [2.75]	0.098 [2.5]
	L	0.480 [12.2]	2	0.098 ± 0.02 [2.5 ± 0.5]	-	0.520 [13.2]	0.147 [3.74]	0.047 [1.2]	0.171 [4.35]	0.177 [4.5]
	R	0.433 [11]	1	0.087 ± 0.008 [2.2 ± 0.2]	0.197 ± 0.02 [5 ± 0.5]	0.472 [12]	0.244 [6.2]	-	0.148 [3.75]	0.177 [4.5]
81	P*	0.315 [8]	2	0.087 ± 0.012 [2.2 ± 0.3]	-	0.354 [9]	0.147 [3.74]	0.047 [1.2]	0.108 [2.75]	0.138 [3.5]
	L	0.531 [13.5]	2	0.098 ± 0.02 [2.5 ± 0.5]	-	0.571 [14.5]	0.147 [3.74]	0.047 [1.2]	0.171 [4.35]	0.228 [5.8]
	R	0.484 [12.3]	1	0.087 ± 0.008 [2.2 ± 0.2]	0.197 ± 0.02 [5 ± 0.5]	0.524 [13.3]	0.244 [6.2]	-	0.148 [3.75]	0.228 [5.8]
82	P*	0.354 [9]	3	0.087 ± 0.012 [2.2 ± 0.3]	-	0.394 [10]	0.247 [6.28]	0.047 [1.2]	0.108 [2.75]	0.177 [4.5]
	L	0.587 [14.9]	3	0.098 ± 0.02 [2.5 ± 0.5]	-	0.626 [15.9]	0.247 [6.28]	0.047 [1.2]	0.171 [4.35]	0.283 [7.2]
	R	0.642 [16.3]	1	0.138 ± 0.008 [3.5 ± 0.2]	0.315 ± 0.02 [8 ± 0.5]	0.681 [17.3]	0.362 [9.2]	-	0.199 [5.05]	0.283 [7.2]
83	P*	0.472 [12]	4	0.087 ± 0.012 [2.2 ± 0.3]	-	0.512 [13]	0.347 [8.82]	0.047 [1.2]	0.118 [3]	0.276 [7]
	L	0.676 [17.16]	4	0.098 ± 0.02 [2.5 ± 0.5]	-	0.715 [18.16]	0.347 [8.82]	0.047 [1.2]	0.191 [4.85]	0.333 [8.46]
	R	0.731 [18.56]	1	0.138 ± 0.008 [3.5 ± 0.2]	0.315 ± 0.02 [8 ± 0.5]	0.770 [19.56]	0.362 [9.2]	-	0.219 [5.55]	0.333 [8.46]
84	P*	0.610 [15.5]	4	0.087 ± 0.012 [2.2 ± 0.3]	-	0.650 [16.5]	0.347 [8.82]	0.047 [1.2]	0.128 [3.25]	0.394 [10]
	L	0.815 [20.7]	4	0.098 ± 0.02 [2.5 ± 0.5]	-	0.854 [21.7]	0.347 [8.82]	0.047 [1.2]	0.191 [4.85]	0.472 [12]
	R	0.870 [22.1]	1	0.138 ± 0.008 [3.5 ± 0.2]	0.315 ± 0.02 [8 ± 0.5]	0.909 [23.1]	0.362 [9.2]	-	0.219 [5.55]	0.472 [12]
89	P*	0.630 [16]	5	0.087 ± 0.012 [2.2 ± 0.3]	-	0.669 [17]	0.347 [8.82]	0.047 [1.2]	0.128 [3.25]	0.413 [10.5]
	L	0.827 [21]	5	0.098 ± 0.02 [2.5 ± 0.5]	-	0.866 [22]	0.347 [8.82]	0.047 [1.2]	0.191 [4.85]	0.484 [12.3]
	R	0.882 [22.4]	1	0.138 ± 0.008 [3.5 ± 0.2]	0.315 ± 0.02 [8 ± 0.5]	0.921 [23.4]	0.362 [9.2]	-	0.219 [5.55]	0.484 [12.3]
85	P*	0.728 [18.5]	6	0.087 ± 0.012 [2.2 ± 0.3]	-	0.768 [19.5]	0.547 [13.9]	0.047 [1.2]	0.128 [3.25]	0.512 [13]
	L	0.925 [23.5]	6	0.098 ± 0.02 [2.5 ± 0.5]	-	0.965 [24.5]	0.547 [13.9]	0.047 [1.2]	0.191 [4.85]	0.583 [14.8]
	R	0.980 [24.9]	1	0.138 ± 0.008 [3.5 ± 0.2]	0.591 ± 0.02 [15 ± 0.5]	1.020 [25.9]	0.638 [16.2]	-	0.219 [5.55]	0.583 [14.8]
87	P*	1.260 [32]	6	0.087 ± 0.012 [2.2 ± 0.3]	-	1.299 [33]	0.547 [13.9]	0.047 [1.2]	0.128 [3.25]	0.945 [24]
	L	1.398 [35.5]	6	0.098 ± 0.02 [2.5 ± 0.5]	-	1.437 [36.5]	0.547 [13.9]	0.047 [1.2]	0.191 [4.85]	1.055 [26.8]
	R	1.453 [36.9]	1	0.138 ± 0.008 [3.5 ± 0.2]	0.591 ± 0.02 [15 ± 0.5]	1.492 [37.9]	0.638 [16.2]	-	0.219 [5.55]	1.055 [26.8]
88	P*	1.654 [42]	6	0.087 ± 0.012 [2.2 ± 0.3]	-	1.693 [43]	0.547 [13.9]	0.047 [1.2]	0.128 [3.25]	1.378 [35]
	L	1.831 [46.5]	6	0.098 ± 0.02 [2.5 ± 0.5]	-	1.870 [47.5]	0.547 [13.9]	0.047 [1.2]	0.191 [4.85]	1.488 [37.8]
	R	1.886 [47.9]	1	0.138 ± 0.008 [3.5 ± 0.2]	0.591 ± 0.02 [15 ± 0.5]	1.925 [48.9]	0.638 [16.2]	-	0.219 [5.55]	1.488 [37.8]

\* For PL and PLS, add 0.098 in [2.5 mm] to d and I2 and 0.197 in [5 mm] to C1.

# High Voltage Chips Capacitors

# C Series

**According to**  
Available space ranges:  
consult our detail  
specifications



## ELECTRICAL SPECIFICATIONS

Dielectric	NPO	C4xx	X7R
<b>Dielectric code</b>	<b>1</b>	<b>4</b>	<b>2</b>
<b>Maximum <math>\Delta C/^\circ C</math> over temperature range without voltage</b>	NA	NA	$\pm 15\%$
<b>Temperature coefficient</b>	$(0 \pm 30)$ ppm/ $^\circ C$	$(-2,200 \pm 500)$ ppm/ $^\circ C$	NA
<b>Aging</b>	None	None	$\leq 2.5\%$ per decade hour
<b>Operating temperature</b>	$-55^\circ C$ to $+125^\circ C$		
<b>Rated voltage (<math>U_{RC}</math>)</b>	200 $V_{DC}$ to 10,000 $V_{DC}$	200 $V_{DC}$ to 5,000 $V_{DC}$	200 $V_{DC}$ to 10,000 $V_{DC}$
<b>Dielectric withstanding voltage</b>	2.5 $U_{RC}$ for $U_{RC} \leq 500 V_{DC}$ 1.6 $U_{RC}$ for $U_{RC} \geq 1,000 V_{DC}$ <b>Extended range:</b> 2 $U_{RC}$ for $U_{RC} \leq 500 V_{DC}$ 1.3 $U_{RC}$ for $U_{RC} \geq 1,000 V_{DC}$	2.5 $U_{RC}$ for $U_{RC} = 200 V_{DC}$ 2 $U_{RC}$ for $U_{RC} = 500 V_{DC}$ 1.5 $U_{RC}$ for $U_{RC} = 1,000 V_{DC}$ 1.4 $U_{RC}$ for $U_{RC} > 1,000 V_{DC}$ <b>Extended range:</b> 1.5 $U_{RC}$ for $U_{RC} \leq 500 V_{DC}$ 1.2 $U_{RC}$ for $U_{RC} \geq 1,000 V_{DC}$	2.5 $U_{RC}$ for $U_{RC} = 200 V_{DC}$ 2 $U_{RC}$ for $U_{RC} = 500 V_{DC}$ 1.5 $U_{RC}$ for $U_{RC} = 1,000 V_{DC}$ 1.2 $U_{RC}$ for $U_{RC} > 1,000 V_{DC}$ <b>Extended range:</b> 1.5 $U_{RC}$ for $U_{RC} \leq 500 V_{DC}$ 1.2 $U_{RC}$ for $U_{RC} \geq 1,000 V_{DC}$
<b>Capacitance</b>	at 1 MHz for $C \leq 1,000$ pF at 1 kHz for $C > 1,000$ pF		at 1 kHz
<b>Dissipation factor</b>	$\leq 0.015$ at 1 MHz for $C \leq 50$ pF $\leq 0.15\%$ at 1 MHz for $50$ pF $< C < 1,000$ pF $\leq 0.15\%$ at 1 kHz for $C > 1,000$ pF	$\leq 0.10\%$ at 1 kHz	$\leq 2.5\%$ at 1 kHz
<b>Insulation resistance at 25<math>^\circ C</math> under <math>U_{RC}</math> for <math>U_{RC} \leq 500V_{DC}</math> under 500<math>V_{DC}</math> for <math>U_{RC} &gt; 500V_{DC}</math></b>	$\geq 100,000 M\Omega$ for $C \leq 10$ nF $\geq 1,000 M\Omega \mu F$ for $C > 10$ nF	$\geq 20,000 M\Omega$ for $C \leq 25$ nF $\geq 500 M\Omega \mu F$ for $C > 25$ nF	

## FEATURES

- Multilayer chip ceramic capacitors
- Size 1515 to 16080
- NPO, C4xx and X7R dielectrics
- Capacitance range: 10 pF to 39  $\mu F$
- Voltage range: 200  $V_{DC}$  to 10,000  $V_{DC}$

## PHYSICAL CHARACTERISTICS

### CONSTRUCTION

- C Series: Unleaded chip capacitors for surface mounting with optional tinning.
- P, PL, L models: DIL leaded uncoated chip capacitors for surface mounting recommended to eliminate thermomechanical stresses.
- N, NU models: DIL leaded chip capacitors for through-hole circuits (N: varnished chips, NU: uncoated chips).
- R, RU models: Ribbon leaded chip capacitors for surface mounting (R: varnished chips, RU: uncoated chips) recommended to eliminate thermomechanical stresses.

### MARKING (On request on unleaded chips)

Series, capacitance value, tolerance, rated voltage clear or coded, date code.

C	2	80	C	P	M	F	1 $\mu F$	10%	200V	S12	T5		
Series	Dielectric	Exxelia size code	Termination (Bare chips only)	Leads style + finishing (Leaded chips only)	Marking	Quality level	Capacitance	Tolerance	Rated voltage	Packaging	Reliability level		
C = High voltage chip capacitor	1 = NPO 2 = X7R 4 = C4xx	78 = 1515	<b>W</b> = RoHS compliant		<b>P</b> PW - RoHS <b>PL</b> PLW - RoHS <b>L</b> LW - RoHS <b>R</b> RW - RoHS <b>RU</b> RUW - RoHS <b>N</b> NW - RoHS <b>NU</b> NUW - RoHS	- = standard quality level  <b>F</b> = Hi-Rel quality: screening in accordance with Exxelia specification	Capacitance value in clear	For NPO dielectric: $\pm 1\%$ $\pm 2\%$ $\pm 5\%$ $\pm 10\%$ $\pm 20\%$  For C4xx dielectric: $\pm 2\%$ $\pm 5\%$ $\pm 10\%$ $\pm 20\%$  For X7R dielectric: $\pm 10\%$ $\pm 20\%$	200V 500V 1,000V 1,500V 2,000V 3,000V 4,000V 5,000V 7,500V 10,000V	- = Exxelia packaging (leaded chips: thermoformed packaging)  Only available for unleaded chips: S12 = Super 12 reel Sizes 1515 - 2220: S12 = Super 12 reel Sizes 1812 and 2220 BA = Tray package (non oriented chips) BA0 = Tray package (oriented chips) See page 13	For F parts only. Acc. to Exxelia spec. - <b>T5</b> <b>T6</b>  See page 15		
		79 = 1812	For all sizes										
		90 = 1825	-	Ag/Pd/Pt								<b>W</b>	Ag/Pd/Pt
		80 = 2220	<b>Q</b>	wAg								<b>QW</b>	Ag
		91 = 2225	From 1812 to 3333 sizes										
		81 = 2825	-	Ag/Pd/Pt								<b>W</b>	Ag/Pd/Pt
		82 = 3333	<b>H</b>	Ag/Pd/Pt + dipped Sn/Pb 60/40								<b>HW</b>	Ag/Pd/Pt + dipped Sn
		83 = 4040	<b>E</b>	Ni + dipped Sn/Pb 60/40								<b>EW</b>	Ni + dipped Sn
		84 = 5440	<b>C</b>	Ni + electrolytic Sn/Pb 95/5								<b>CW</b>	Ni + electrolytic Sn
		89 = 5550	<b>D</b>	Ag + Ni + electrolytic Sn/Pb 60/40								-	-
		85 = 6560	<b>G</b>	Ni + electrolytic Gold								-	-
		87 = 11283	From 1812 to 4040 sizes										
88 = 16080	<b>YC</b>	Ag + Polymer + Ni + Sn/Pb 95/5	<b>YCW</b>	Ag + Polymer + Ni + Sn									
	<b>YD</b>	Ag + Polymer + Ni + Sn/Pb 60/40	-	-									
	<b>YG</b>	Ag + Polymer + Ni + Au	<b>YGW</b>	Ag + Polymer + Ni + Au									

HIGH VOLTAGE

# C Series

## High Voltage Chips Capacitors

### DIMENSIONS in inches (mm)

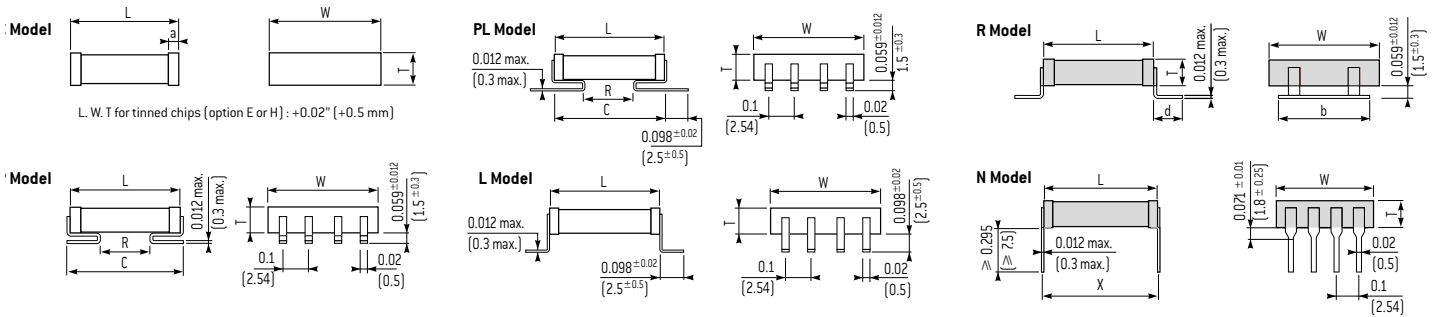

### STANDARD RATINGS

	Size	1515	1812	1825	2220	2225	2825	3333														
	Exxelia size code	78	79	90	80	91	81	82														
Dimensions inches (mm)	L*	0.15 ± 0.015 (3.8 ± 0.38)	0.177 ± 0.020 (4.5 ± 0.5)	0.177 ± 0.020 (4.5 ± 0.5)	0.224 ± 0.020 (5.7 ± 0.5)	0.224 ± 0.020 (5.7 ± 0.5)	0.276 ± 0.020 (7 ± 0.5)	0.331 ± 0.020 (8.4 ± 0.5)														
	W*	0.15 ± 0.015 (3.8 ± 0.38)	0.126 ± 0.020 (3.2 ± 0.5)	0.250 ± 0.020 (6.35 ± 0.5)	0.197 ± 0.020 (5.0 ± 0.5)	0.250 ± 0.020 (6.35 ± 0.5)	0.250 ± 0.020 (6.35 ± 0.5)	0.331 ± 0.020 (8.4 ± 0.5)														
	a	0.012 min (0.3 min)	0.024 ± 0.020 (0.6 ± 0.5)	0.024 ± 0.020 (0.6 ± 0.5)	0.028 ± 0.020 (0.7 ± 0.5)	0.028 ± 0.020 (0.7 ± 0.5)	0.039 ± 0.020 (1 ± 0.5)	0.039 ± 0.020 (1 ± 0.5)														
	d	-	-	0.087 ± 0.008 (2.2 ± 0.2)	0.087 ± 0.008 (2.2 ± 0.2)	0.087 ± 0.008 (2.2 ± 0.2)	0.087 ± 0.008 (2.2 ± 0.2)	0.138 ± 0.008 (3.5 ± 0.2)														
	b	-	-	0.197 ± 0.020 (5 ± 0.5)	0.197 ± 0.020 (5 ± 0.5)	0.197 ± 0.020 (5 ± 0.5)	0.197 ± 0.020 (5 ± 0.5)	0.315 ± 0.020 (8 ± 0.5)														
	R min.	-	-	0.066 (1.7)	0.098 (2.5)	0.098 (2.5)	0.137 (3.5)	0.177 (4.5)														
	C max.	-	-	0.229 (5.8)	0.276 (7)	0.276 (7)	0.315 (8)	0.355 (9)														
	X	-	-	0.2 ± 0.020 (5.08 ± 0.5)	0.248 ± 0.020 (6.3 ± 0.5)	0.248 ± 0.020 (6.3 ± 0.5)	0.300 ± 0.020 (7.62 ± 0.5)	0.350 ± 0.020 (8.9 ± 0.5)														
	Leads per side	-	-	2	2	2	2	3														
	T max.*	0.154 (3.9)	0.138 (3.5)	0.138 (3.5)	0.2kV up to 3kV: 0.119 (3) 4kV-5kV: 0.150 (3.8)	0.2kV up to 3kV: 0.158 (4) 4kV-5kV: 0.197 (5)	0.2kV up to 3kV: 0.158 (4) 4kV: 0.197 (5) 5kV: 0.237 (6)	0.2kV up to 3kV: 0.158 (4) 4kV: 0.197 (5) 5kV: 0.237 (6)														
Dielectric	NPD	X7R	NPD	C4xx	X7R	NPD	C4xx	X7R	NPD	C4xx	X7R	NPD	C4xx	X7R	NPD	C4xx	X7R	NPD	C4xx	X7R		
	Exxelia ceramic code	1	2	1	4	2	1	4	2	1	4	2	1	4	2	1	4	2	1	4	2	
Min. Capacitance value	12pF	120pF	10pF	27pF	100pF	10pF	33pF	150pF	10pF	33pF	150pF	15pF	47pF	150pF	18pF	56pF	150pF	33pF	82pF	330pF		
Rated voltage (U <sub>RC</sub> )	0.2kV	Standard	-	-	5.6nF	120nF	220nF	12nF	220nF	470nF	12nF	220nF	390nF	15nF	330nF	560nF	18nF	390nF	820nF	33nF	680nF	1.5µF
		Extended	-	-	18nF	-	470nF	27nF	-	-	22nF	-	1µF	39nF	-	-	56nF	-	1.8µF	100nF	-	2.7µF
	0.5kV	Standard	-	-	3.3nF	22nF	47nF	6.8nF	47nF	100nF	5.6nF	47nF	100nF	6.8nF	68nF	150nF	8.2nF	82nF	220nF	22nF	120nF	390nF
		Extended	-	-	10nF	39nF	150nF	18nF	68nF	-	18nF	68nF	270nF	22nF	100nF	-	27nF	120nF	560nF	68nF	220nF	1µF
	1kV	Standard	-	-	1.8nF	6.8nF	15nF	2.7nF	12nF	22nF	2.2nF	12nF	22nF	3.3nF	18nF	33nF	3.9nF	22nF	47nF	10nF	39nF	68nF
		Extended	820pF	12nF	5.6nF	10nF	27nF	8.2nF	15nF	-	6.8nF	15nF	56nF	10nF	22nF	-	12nF	27nF	120nF	33nF	56nF	220nF
	1.5kV	Standard	-	-	820pF	2.7nF	5.6nF	1.2nF	5.6nF	10nF	1.5nF	5.6nF	10nF	2.2nF	8.2nF	15nF	2.7nF	10nF	18nF	4.7nF	18nF	33nF
		Extended	-	-	1.5nF	3.9nF	12nF	2.2nF	8.2nF	-	2.2nF	6.8nF	22nF	3.3nF	12nF	-	4.7nF	15nF	47nF	8.2nF	27nF	82nF
	2kV	Standard	-	-	390pF	1.5nF	3.3nF	680pF	2.7nF	5.6nF	470pF	2.7nF	5.6nF	820pF	4.7nF	6.8nF	1.2nF	5.6nF	10nF	3.3nF	10nF	18nF
		Extended	470pF	2.7nF	820pF	2.2nF	5.6nF	1.2nF	3.9nF	-	1nF	3.9nF	12nF	1.8nF	6.8nF	-	2.7nF	8.2nF	27nF	6.8nF	15nF	47nF
3kV	Standard	-	-	180pF	680pF	1.2nF	180pF	1.2nF	2.2nF	220pF	1.2nF	2.2nF	330pF	1.8nF	3.3nF	470pF	2.2nF	3.9nF	820pF	3.9nF	6.8nF	
	Extended	220pF	1nF	390pF	1nF	2.7nF	680pF	1.8nF	-	470pF	1.8nF	4.7nF	820pF	2.7nF	-	1nF	3.3nF	12nF	1.8nF	5.6nF	22nF	
4kV	Standard	-	-	100pF	330pF	680pF	120pF	680pF	1nF	150pF	820pF	1.2nF	220pF	1.2nF	1.8nF	390pF	1.5nF	2.7nF	680pF	3.3nF	4.7nF	
	Extended	150pF	470pF	220pF	560pF	-	330pF	1nF	-	330pF	1.2nF	2.2nF	680pF	1.8nF	-	820pF	2.2nF	4.7nF	1.5nF	4.7nF	10nF	
5kV	Standard	-	-	-	-	-	-	-	-	100pF	560pF	820pF	150pF	820pF	1nF	270pF	1nF	1.8nF	470pF	2.2nF	3.3nF	
	Extended	-	-	-	-	-	-	-	-	220pF	820pF	1.5nF	320pF	1.2nF	-	560pF	1.5nF	3.3nF	1nF	2.7nF	6.8nF	

# High Voltage Chips Capacitors

# C Series

## STANDARD RATINGS

Size		4040			5440			5550			6560			11283			16080			
Exxelia size code		83			84			89			85			87			88			
Dimensions inches (mm)	L*	0.400 ± 0.039 (10.16 ± 1)			0.539 ± 0.039 (13.7 ± 1)			0.551 ± 0.039 (14 ± 1)			0.650 ± 0.039 (16.5 ± 1)			1.122 ± 0.039 (28.5 ± 1)			1.555 ± 0.039 (39.5 ± 1)			
	W*	0.400 ± 0.039 (10.16 ± 1)			0.400 ± 0.039 (10.16 ± 1)			0.500 ± 0.039 (12.7 ± 1)			0.598 ± 0.039 (15.2 ± 1)			0.827 ± 0.039 (21 ± 1)			0.756 ± 0.039 (19.2 ± 1)			
	a	0.059 ± 0.020 (1.5 ± 0.5)			0.059 ± 0.020 (1.5 ± 0.5)			0.059 ± 0.020 (1.5 ± 0.5)			0.059 ± 0.020 (1.5 ± 0.5)			0.059 ± 0.020 (1.5 ± 0.5)			0.059 ± 0.020 (1.5 ± 0.5)			
	d	0.138 ± 0.008 (3.5 ± 0.2)			0.138 ± 0.008 (3.5 ± 0.2)			0.138 ± 0.008 (3.5 ± 0.2)			0.138 ± 0.008 (3.5 ± 0.2)			0.138 ± 0.008 (3.5 ± 0.2)			0.138 ± 0.008 (3.5 ± 0.2)			
	b	0.315 ± 0.020 (8 ± 0.5)			0.315 ± 0.020 (8 ± 0.5)			0.315 ± 0.020 (8 ± 0.5)			0.591 ± 0.020 (15 ± 0.5)			0.591 ± 0.020 (15 ± 0.5)			0.591 ± 0.020 (15 ± 0.5)			
	R min.	0.275 (7)			0.393 (10)			0.393 (10)			0.511 (13)			0.984 (25)			1.377 (35)			
	C max.	0.473 (12)			0.611 (15.5)			0.63 (16)			0.729 (18.5)			1.26 (32)			1.654 (42)			
	X	0.45 ± 0.020 (11.43 ± 0.5)			0.551 ± 0.020 (14 ± 0.5)			0.563 ± 0.020 (14.3 ± 0.5)			0.7 ± 0.020 (17.78 ± 0.5)			1.15 ± 0.020 (29.21 ± 0.5)			1.6 ± 0.020 (40.64 ± 0.5)			
	Leads per side	4			4			5			6			6			6			
	T max.*	0.2kV up to 3kV: 0.158 (4) 4kV: 0.197 (5) 5kV up to 10kV: 0.237 (6)			0.2kV up to 3kV: 0.158 (4) 4kV: 0.197 (5) 5kV up to 10kV: 0.237 (6)			0.2kV up to 3kV: 0.158 (4) 4kV: 0.197 (5) 5kV up to 10kV: 0.237 (6)			0.2kV up to 3kV: 0.158 (4) 4kV: 0.197 (5) 5kV up to 10kV: 0.237 (6)			0.2kV up to 3kV: 0.158 (4) 4kV: 0.197 (5) 5kV up to 10kV: 0.237 (6) 7.5kV up to 10kV: 0.256 (6.5)			0.2kV up to 3kV: 0.158 (4) 4kV: 0.197 (5) 5kV: 0.236 (6) 7.5kV up to 10kV: 0.256 (6.5)			
Dielectric		NPO			C4xx			X7R			NPO			C4xx			X7R			
Exxelia ceramic code		1			4			2			1			4			2			
Min. Capacitance value		10pF			180pF			270pF			22pF			390pF			27pF			
Rated voltage (U <sub>ric</sub> )	0.2kV	Standard	56nF	1.2µF	2.7µF	82nF	1.5µF	3.9µF	100nF	1.8µF	4.7µF	180nF	2.7µF	6.8µF	330nF	6.8µF	12µF	390nF	8.2µF	15µF
		Extended	180nF	-	5.6µF	270nF	-	6.8µF	220nF	-	8.2µF	560nF	-	12µF	1µF	-	33µF	1.2µF	-	39µF
	0.5kV	Standard	33nF	270nF	680nF	47nF	330nF	1µF	56nF	390nF	1.2µF	82nF	680nF	1.8µF	150nF	1.5µF	3.9µF	270nF	1.8µF	4.7µF
		Extended	100nF	390nF	1.5µF	150nF	560nF	2.2µF	150nF	680nF	2.7µF	270nF	1µF	3.9µF	470nF	2.2µF	10µF	820nF	2.7µF	12µF
	1kV	Standard	15nF	82nF	150nF	22nF	82nF	220nF	33nF	120nF	270nF	39nF	220nF	390nF	82nF	560nF	1µF	150nF	680nF	1.2µF
		Extended	47nF	120nF	390nF	68nF	120nF	560nF	82nF	220nF	560nF	120nF	330nF	1µF	270nF	680nF	2.7µF	470nF	1µF	3.3µF
	1.5kV	Standard	8.2nF	39nF	82nF	12nF	39nF	100nF	15nF	68nF	150nF	22nF	100nF	180nF	47nF	220nF	470nF	68nF	330nF	560nF
		Extended	18nF	56nF	180nF	22nF	56nF	220nF	33nF	100nF	330nF	47nF	150nF	470nF	100nF	330nF	1.2µF	150nF	470nF	1.5µF
	2kV	Standard	4.7nF	18nF	33nF	6.8nF	22nF	68nF	8.2nF	39nF	68nF	12nF	56nF	100nF	27nF	120nF	220nF	39nF	180nF	330nF
		Extended	10nF	27nF	100nF	15nF	33nF	150nF	18nF	56nF	150nF	27nF	82nF	220nF	56nF	180nF	560nF	82nF	270nF	820nF
	3kV	Standard	1.5nF	8.2nF	15nF	2.7nF	10nF	27nF	3.3nF	18nF	27nF	4.7nF	27nF	39nF	12nF	56nF	100nF	15nF	68nF	120nF
		Extended	3.3nF	12nF	39nF	5.6nF	15nF	56nF	10nF	22nF	68nF	10nF	39nF	100nF	27nF	82nF	270nF	33nF	100nF	330nF
	4kV	Standard	1.2nF	6.8nF	10nF	2.2nF	6.8nF	15nF	2.7nF	12nF	18nF	3.9nF	18nF	27nF	10nF	39nF	68nF	12nF	47nF	100nF
		Extended	2.7nF	10nF	18nF	4.7nF	10nF	27nF	6.8nF	18nF	39nF	8.2nF	27nF	47nF	22nF	56nF	120nF	27nF	82nF	150nF
	5kV	Standard	1nF	4.7nF	5.6nF	1.8nF	4.7nF	10nF	1.8nF	8.2nF	12nF	3.3nF	12nF	18nF	8.2nF	27nF	56nF	10nF	33nF	68nF
		Extended	2.2nF	6.8nF	15nF	3.9nF	6.8nF	22nF	4.7nF	12nF	27nF	6.8nF	18nF	39nF	15nF	39nF	82nF	18nF	47nF	100nF
	7.5kV	Standard	150pF	-	1.5nF	270pF	-	2.7nF	470pF	-	3.3nF	560pF	-	6.8nF	1.5nF	-	18nF	2.2nF	-	27nF
		Extended	330pF	-	3.3nF	560pF	-	5.6nF	1.2nF	-	6.8nF	1.2nF	-	12nF	3.3nF	-	33nF	4.7nF	-	47nF
	10kV	Standard	100pF	-	680pF	180pF	-	1.2nF	270pF	-	1.5nF	390pF	-	3.3nF	1nF	-	8.2nF	1.5nF	-	12nF
		Extended	220pF	-	1.8nF	390pF	-	3.3nF	680pF	-	3.9nF	820pF	-	6.8nF	2.2nF	-	15nF	3.3nF	-	27nF

\* For E, EW, H and HW: add +0.020 inch (+0.5 mm) to L, W and T dimensions.  
 The high voltage parts may require varnish or encapsulation to prevent surface arcing.  
 Available capacitance values:  
 NPO, C4xx dielectrics: E6, E12, E24 (see page 14). Specific values upon request.  
 X7R dielectric: E6, E12 in standard (see page 14). Specific values upon request.  
 The above table defines the standard products, other components may be built upon request.

HIGH VOLTAGE

# TCL / TCK Series

## High Voltage Molded & Varnished Leaded Capacitors



According to (TCK)  
Available space ranges:  
consult our detail  
specifications

### FEATURES

- Multilayer chip ceramic capacitors
- NPO, C4xx and X7R dielectrics
- Capacitance range: 10 pF to 39 μF
- Voltage range: 200 V<sub>DC</sub> to 10,000 V<sub>DC</sub>

### PHYSICAL CHARACTERISTICS

#### CONSTRUCTION

- **TCK Series:** molded (semi-hard epoxy resin) radial leaded chip capacitors for through-hole circuits. Models suited for harsh environmental conditions.
- **TCL Series:** varnished radial leaded chip capacitors for through-hole circuits. Models suited to applications for reduced size is required with minimum exposure to external constraint, or to assemblies potted by the user.

#### MARKING

Series, capacitance value, tolerance, rated voltage clear or coded for TCK, date code.

### ELECTRICAL SPECIFICATIONS

DIELECTRIC	NPO	C4xx	X7R
<b>Dielectric code</b>	1	4	2
<b>Maximum ΔC/°C over temperature range without voltage</b>	NA	NA	±15%
<b>Temperature coefficient</b>	(0 ± 30) ppm/°C	(-2,200 ± 500) ppm/°C	NA
<b>Aging</b>	None	None	≤ 2.5% per decade hour
<b>Operating temperature</b>	-55°C to +125°C		
<b>Rated voltage (U<sub>RC</sub>)</b>	200 V <sub>DC</sub> to 10,000 V <sub>DC</sub>	200 V <sub>DC</sub> to 5,000 V <sub>DC</sub>	200 V <sub>DC</sub> to 10,000 V <sub>DC</sub>
<b>Dielectric withstanding voltage</b>	2.5 U <sub>RC</sub> for U <sub>RC</sub> ≤ 500 V <sub>DC</sub> 1.6 U <sub>RC</sub> for U <sub>RC</sub> ≥ 1,000 V <sub>DC</sub> <b>Extended range:</b> 2 U <sub>RC</sub> for U <sub>RC</sub> ≤ 500 V <sub>DC</sub> 1.3 U <sub>RC</sub> for U <sub>RC</sub> ≥ 1,000 V <sub>DC</sub>	2.5 U <sub>RC</sub> for U <sub>RC</sub> = 200 V <sub>DC</sub> 2 U <sub>RC</sub> for U <sub>RC</sub> = 500 V <sub>DC</sub> 1.5 U <sub>RC</sub> for U <sub>RC</sub> = 1,000 V <sub>DC</sub> 1.4 U <sub>RC</sub> for U <sub>RC</sub> > 1,000 V <sub>DC</sub> <b>Extended range:</b> 1.5 U <sub>RC</sub> for U <sub>RC</sub> ≤ 500 V <sub>DC</sub> 1.2 U <sub>RC</sub> for U <sub>RC</sub> ≥ 1,000 V <sub>DC</sub>	2.5 U <sub>RC</sub> for U <sub>RC</sub> = 200 V <sub>DC</sub> 2 U <sub>RC</sub> for U <sub>RC</sub> = 500 V <sub>DC</sub> 1.5 U <sub>RC</sub> for U <sub>RC</sub> = 1,000 V <sub>DC</sub> 1.2 U <sub>RC</sub> for U <sub>RC</sub> > 1,000 V <sub>DC</sub> <b>Extended range:</b> 1.5 U <sub>RC</sub> for U <sub>RC</sub> ≤ 500 V <sub>DC</sub> 1.2 U <sub>RC</sub> for U <sub>RC</sub> ≥ 1,000 V <sub>DC</sub>
<b>Capacitance</b>	at 1 MHz for C ≤ 1,000 pF at 1 kHz for C > 1,000 pF	at 1 kHz	at 1 kHz
<b>Dissipation factor</b>	≤ 0.015 (150/C + 7)% at 1 MHz for C ≤ 50 pF ≤ 0.15% at 1 MHz for 50 pF < C ≤ 1,000 pF ≤ 0.15% at 1 kHz for C > 1,000 pF	≤ 0.10% at 1 kHz	≤ 2.5% at 1 kHz
<b>Insulation resistance at 25°C under U<sub>RC</sub> for U<sub>RC</sub> ≤ 500 V under 500 V<sub>DC</sub> for U<sub>RC</sub> &gt; 500 V</b>	≥ 100,000 MΩ for C ≤ 10 nF ≥ 1,000 MΩ.μF for C > 10 nF	≥ 20,000 MΩ for C ≤ 25 nF ≥ 500 MΩ.μF for C > 25 nF	
<b>Voltage proof body insulation</b>	Only for TCK Series: under U <sub>RC</sub> for U <sub>RC</sub> ≤ 1,250 V <sub>DC</sub> under 1,300 V <sub>DC</sub> for U <sub>RC</sub> > 1,250 V <sub>DC</sub>		

### HOW TO ORDER

TCK	1	82	UL	W	F	680pF	10%	4,000 V	-	B
Series	Dielectric code	Exxelia size code	UL94V0 compliant	RoHS compliant	Quality level	Capacitance	Tolerance	Rated voltage	Packaging	Reliability level
<b>TCK</b> = Molded radial leaded capacitor	1 = NPO 2 = X7R 4 = C4xx	79 90 80 91	Only available for TCK Series:	- = No RoHS W = RoHS compliant	- = standard quality level F = Hi-Rel quality: screening in accordance with Exxelia specification	Capacitance value in clear	NPO dielectric: ±1% ±2% ±5% ±10% ±20% C4xx dielectric: ±2% ±5% ±10% ±20% X7R dielectric: ±10% ±20%	200 V 500 V 1,000 V 2,000 V 3,000 V 4,000 V 5,000 V 7,500 V 10,000 V	Only available for TCK Series: B = Reel option: Contact your sales representative.	For F parts only. Acc. to Exxelia spec. - T5 T6 See page 15
<b>TCL</b> = Varnished radial leaded capacitor		81 82 83 84 89 85 87 88	UL = UL94V0 compliant					Intermediary and higher voltages available: contact your sales representative.		

High Voltage Molded & Varnished Leaded Capacitors

TCL / TCK Series

DIMENSIONS in inches (mm)

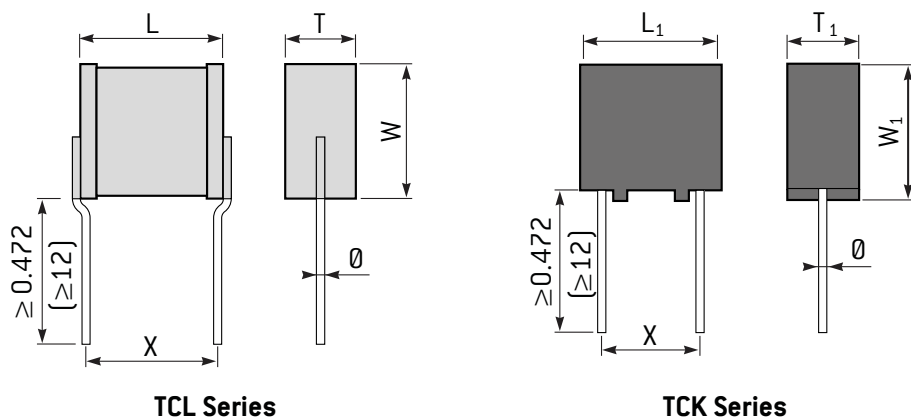

STANDARD RATINGS

		Exxelia size code			79			90			80			91			81			82		
Dimensions inches (mm)	L max.	0.237 (6)			0.237 (6)			0.276 (7)			0.276 (7)			0.355 (9)			0.394 (10)					
	W max.	0.197 (5)			0.296 (7.5)			0.276 (7)			0.296 (7.5)			0.296 (7.5)			0.394 (10)					
	T max.	0.138 (3.5)			0.138 (3.5)			0.2kV up to 3kV: 0.118 (3) 4kV-5kV: 0.150 (3.8)			0.2kV up to 3kV: 0.158 (4) 4kV-5kV: 0.197 (5)			0.2kV up to 3kV: 0.158 (4) 4kV: 0.197 (5) 5kV: 0.237 (6)			0.2kV up to 3kV: 0.158 (4) 4kV: 0.197 (5) 5kV: 0.237 (6)					
	L <sub>1</sub>	0.284 ± 0.020 (7.2 ± 0.5)			0.284 ± 0.020 (7.2 ± 0.5)			0.315 ± 0.020 (8 ± 0.5)			0.315 ± 0.020 (8 ± 0.5)			0.413 ± 0.020 (10.5 ± 0.5)			0.512 ± 0.020 (13 ± 0.5)					
	W <sub>1</sub>	0.197 ± 0.020 (5 ± 0.5)			0.37 ± 0.020 (9.4 ± 0.5)			0.315 ± 0.020 (8 ± 0.5)			0.37 ± 0.020 (9.4 ± 0.5)			0.354 ± 0.020 (9 ± 0.5)			0.472 ± 0.020 (12 ± 0.5)					
	T <sub>1</sub> max.	0.197 (5)			0.197 (5)			0.197 (5)			0.2kV up to 3kV: 0.256 (6.5) 4kV-5kV: 0.296 (7.5)			0.2kV up to 3kV: 0.256 (6.5) 4kV-5kV: 0.315 (8)			0.2kV up to 3kV: 0.256 (6.5) 4kV-5kV: 0.315 (8)					
	Ø ± 10%	0.024 (0.6)			0.024 (0.6)			0.024 (0.6)			0.024 (0.6)			0.031 (0.8)			0.031 (0.8)					
X	0.2 ± 0.020 (5.08 ± 0.5)			0.2 ± 0.020 (5.08 ± 0.5)			0.2 ± 0.020 (5.08 ± 0.5)			0.2 ± 0.020 (5.08 ± 0.5)			0.3 ± 0.020 (7.62 ± 0.5)			0.4 ± 0.020 (10.16 ± 0.5)						
Dielectric		NPO	C4xx	X7R	NPO	C4xx	X7R	NPO	C4xx	X7R	NPO	C4xx	X7R	NPO	C4xx	X7R	NPO	C4xx	X7R			
Exxelia ceramic code		1	4	2	1	4	2	1	4	2	1	4	2	1	4	2	1	4	2			
Min. Capacitance value		10pF	27pF	100pF	10pF	33pF	150pF	10pF	33pF	150pF	15pF	47pF	150pF	18pF	56pF	150pF	33pF	82pF	330pF			
Rated voltage (U <sub>ric</sub> )	0.2kV	Standard	5.6nF	120nF	220nF	12nF	220nF	470nF	12nF	220nF	390nF	15nF	330nF	560nF	18nF	390nF	820nF	33nF	680nF	1.5µF		
		Extended	18nF	-	470nF	27nF	-	-	22nF	-	1µF	39nF	-	-	56nF	-	1.8µF	100nF	-	2.7µF		
	0.5kV	Standard	3.3nF	22nF	47nF	6.8nF	47nF	100nF	5.6nF	47nF	100nF	6.8nF	68nF	150nF	8.2nF	82nF	220nF	22nF	120nF	390nF		
		Extended	10nF	39nF	150nF	18nF	68nF	-	18nF	68nF	270nF	22nF	100nF	-	27nF	120nF	560nF	68nF	220nF	1µF		
	1kV	Standard	1.8nF	6.8nF	15nF	2.7nF	12nF	24nF	2.2nF	12nF	22nF	3.3nF	18nF	33nF	3.9nF	22nF	47nF	10nF	39nF	68nF		
		Extended	5.6nF	10nF	27nF	8.2nF	15nF	-	6.8nF	15nF	56nF	10nF	22nF	-	12nF	27nF	120nF	33nF	56nF	220nF		
	1.5kV	Standard	820pF	2.7nF	5.6nF	1.2nF	5.6nF	10nF	1.5nF	5.6nF	10nF	2.2nF	8.2nF	15nF	2.7nF	10nF	18nF	4.7nF	18nF	33nF		
		Extended	1.5nF	3.9nF	12nF	2.2nF	8.2nF	-	2.2nF	6.8nF	22nF	3.3nF	12nF	-	4.7nF	15nF	47nF	8.2nF	27nF	82nF		
	2kV	Standard	390pF	1.5nF	3.3nF	680pF	2.7nF	5.6nF	470pF	2.7nF	5.6nF	820pF	4.7nF	6.8nF	1.2nF	5.6nF	10nF	3.3nF	10nF	18nF		
		Extended	820pF	2.2nF	5.6nF	1.2nF	3.9nF	-	1nF	3.9nF	12nF	1.8nF	6.8nF	-	2.7nF	8.2nF	27nF	6.8nF	15nF	47nF		
	3kV	Standard	180pF	680pF	1.2nF	180pF	1.2nF	2.2nF	220pF	1.2nF	2.2nF	330pF	1.8nF	3.3nF	470pF	2.2nF	3.9nF	820pF	3.9nF	6.8nF		
		Extended	390pF	1nF	2.7nF	680pF	1.8nF	-	470pF	1.8nF	4.7nF	820pF	2.7nF	-	1nF	3.3nF	12nF	1.8nF	5.6nF	22nF		
	4kV	Standard	100pF	330pF	680pF	120pF	680pF	1nF	150pF	820pF	1.2nF	220pF	1.2nF	1.8nF	390pF	1.5nF	2.7nF	680pF	3.3nF	4.7nF		
		Extended	220pF	560pF	-	330pF	1nF	-	330pF	1.2nF	2.2nF	680pF	1.8nF	-	820pF	2.2nF	4.7nF	1.5nF	4.7nF	10nF		
	5kV	Standard	-	-	-	-	-	-	100pF	560pF	820pF	150pF	820pF	1nF	270pF	1nF	1.8nF	470pF	2.2nF	3.3nF		
		Extended	-	-	-	-	-	-	220pF	820pF	1.5nF	320pF	1.2nF	-	560pF	1.5nF	3.3nF	1nF	2.7nF	6.8nF		

HIGH VOLTAGE

# TCL / TCK Series

## High Voltage Molded and Varnished Leaded Capacitors

### STANDARD RATINGS

		Exxelia size code	83			84			89			85			87			88		
Dimensions	L max.		0.473 [12]			0.63 [16]			0.642 [16.3]			0.729 [18.5]			1.182 [30]			1.674 [42.5]		
	W max.		0.493 [12.5]			0.493 [12.5]			0.619 [15.7]			0.689 [17.5]			0.886 [22.5]			0.827 [21]		
	T max.		0.2kV up to 3kV: 0.158 [4] 4kV: 0.197 [5] 5kV up to 10kV: 0.237 [6]			0.2kV up to 3kV: 0.158 [4] 4kV: 0.197 [5] 5kV up to 10kV: 0.237 [6]			0.2kV up to 3kV: 0.158 [4] 4kV: 0.197 [5] 5kV up to 10kV: 0.237 [6]			0.2kV up to 3kV: 0.158 [4] 4kV: 0.197 [5] 5kV up to 10kV: 0.237 [6]			0.2kV up to 3kV: 0.158 [4] 4kV: 0.197 [5] 5kV: 0.237 [6] 7.5kV up to 10kV: 0.256 [6.5]			0.2kV up to 3kV: 0.158 [4] 4kV: 0.197 [5] 5kV: 0.237 [6] 7.5kV up to 10kV: 0.256 [6.5]		
	L <sub>1</sub>		0.591 ± 0.020 [15 ± 0.5]			0.709 ± 0.020 [18 ± 0.5]			0.732 ± 0.020 [18.6 ± 0.5]			0.787 ± 0.020 [20 ± 0.5]			1.221 ± 0.020 [31 ± 0.5]			1.772 ± 0.020 [45 ± 0.5]		
	W <sub>1</sub>		0.551 ± 0.020 [14 ± 0.5]			0.630 ± 0.020 [16 ± 0.5]			0.697 ± 0.020 [17.7 ± 0.5]			0.748 ± 0.020 [19 ± 0.5]			0.945 ± 0.020 [24 ± 0.5]			0.906 ± 0.020 [23 ± 0.5]		
	T <sub>1</sub> max.		0.2kV up to 3kV: 0.256 [6.5] 4kV up to 10kV: 0.315 [8]			0.2kV up to 3kV: 0.256 [6.5] 4kV up to 10kV: 0.315 [8]			0.2kV up to 3kV: 0.256 [6.5] 4kV up to 10kV: 0.315 [8]			0.2kV up to 3kV: 0.256 [6.5] 4kV up to 10kV: 0.315 [8]			0.2kV up to 3kV: 0.256 [6.5] 4kV up to 10kV: 0.315 [8]			0.2kV up to 3kV: 0.256 [6.5] 4kV up to 10kV: 0.355 [9]		
	Ø ± 10%		0.031 [0.8]			0.039 [1]			0.039 [1]			0.039 [1]			0.039 [1]			0.039 [1]		
	X		0.5 ± 0.020 [12.7 ± 0.5]			0.6 ± 0.020 [15.24 ± 0.5]			0.6 ± 0.020 [15.24 ± 0.5]			0.7 ± 0.020 [17.8 ± 0.5]			1.1 ± 0.020 [27.94 ± 0.5]			1.6 ± 0.020 [40.64 ± 0.5]		
Dielectric		NPO	C4xx	X7R	NPO	C4xx	X7R	NPO	C4xx	X7R	NPO	C4xx	X7R	NPO	C4xx	X7R	NPO	C4xx	X7R	
Exxelia ceramic code		1	4	2	1	4	2	1	4	2	1	4	2	1	4	2	1	4	2	
Min. Capacitance value		10pF	180pF	270pF	22pF	270pF	390pF	27pF	390pF	560pF	47pF	470pF	1nF	120pF	1nF	2.2nF	150pF	1.8nF	2.7nF	
Rated voltage (U <sub>ric</sub> )	0.2kV	Standard	56nF	1.2µF	2.7µF	82nF	1.5µF	3.9µF	100nF	1.8µF	4.7µF	180nF	2.7µF	6.8µF	330nF	6.8µF	12µF	390nF	8.2µF	15µF
		Extended	180nF	-	5.6µF	270nF	-	6.8µF	220nF	-	8.2µF	560nF	-	12µF	1µF	-	33µF	1.2µF	-	39µF
	0.5kV	Standard	33nF	270nF	680nF	47nF	330nF	1µF	56nF	390nF	1.2µF	82nF	680nF	1.8µF	150nF	1.5µF	3.9µF	270nF	1.8µF	4.7µF
		Extended	100nF	390nF	1.5µF	150nF	560nF	2.2µF	150nF	680nF	2.7µF	270nF	1µF	3.9µF	470nF	2.2µF	10µF	820nF	2.7µF	12µF
	1kV	Standard	15nF	82nF	150nF	22nF	82nF	220nF	33nF	120nF	270nF	39nF	220nF	390nF	82nF	560nF	1µF	150nF	680nF	1.2µF
		Extended	47nF	120nF	390nF	68nF	120nF	560nF	82nF	220nF	560nF	120nF	330nF	1µF	270nF	680nF	2.7µF	470nF	1µF	3.3µF
	1.5kV	Standard	8.2nF	39nF	82nF	12nF	39nF	100nF	15nF	68nF	150nF	22nF	100nF	180nF	47nF	220nF	470nF	68nF	330nF	560nF
		Extended	18nF	56nF	180nF	22nF	56nF	220nF	33nF	100nF	330nF	47nF	150nF	470nF	100nF	330nF	1.2µF	150nF	470nF	1.5µF
	2kV	Standard	4.7nF	18nF	33nF	6.8nF	22nF	68nF	8.2nF	39nF	68nF	12nF	56nF	100nF	27nF	120nF	220nF	39nF	180nF	330nF
		Extended	10nF	27nF	100nF	15nF	33nF	150nF	18nF	56nF	150nF	27nF	82nF	220nF	56nF	180nF	560nF	82nF	270nF	820nF
	3kV	Standard	1.5nF	8.2nF	15nF	2.7nF	10nF	27nF	3.3nF	18nF	27nF	4.7nF	27nF	39nF	12nF	56nF	100nF	15nF	68nF	120nF
		Extended	3.3nF	12nF	39nF	5.6nF	15nF	56nF	10nF	22nF	68nF	10nF	39nF	100nF	27nF	82nF	270nF	33nF	100nF	330nF
	4kV	Standard	1.2nF	6.8nF	10nF	2.2nF	6.8nF	15nF	2.7nF	12nF	18nF	3.9nF	18nF	27nF	10nF	39nF	68nF	12nF	47nF	100nF
		Extended	2.7nF	10nF	18nF	4.7nF	10nF	27nF	6.8nF	18nF	39nF	8.2nF	27nF	47nF	22nF	56nF	120nF	27nF	82nF	150nF
	5kV	Standard	1nF	4.7nF	5.6nF	1.8nF	4.7nF	10nF	1.8nF	8.2nF	12nF	3.3nF	12nF	18nF	8.2nF	27nF	56nF	10nF	33nF	68nF
		Extended	2.2nF	6.8nF	15nF	3.9nF	6.8nF	22nF	4.7nF	12nF	27nF	6.8nF	18nF	39nF	15nF	39nF	82nF	18nF	47nF	100nF
	7.5kV	Standard	150pF	-	1.5nF	270pF	-	2.7nF	470pF	-	3.3nF	560pF	-	6.8nF	1.5nF	-	18nF	2.2nF	-	27nF
		Extended	330pF	-	3.3nF	560pF	-	5.6nF	1.2nF	-	6.8nF	1.2nF	-	12nF	3.3nF	-	33nF	4.7nF	-	47nF
	10kV	Standard	100pF	-	680pF	180pF	-	1.2nF	270pF	-	1.5nF	390pF	-	3.3nF	1nF	-	8.2nF	1.5nF	-	12nF
		Extended	220pF	-	1.8nF	390pF	-	3.3nF	680pF	-	3.9nF	820pF	-	6.8nF	2.2nF	-	15nF	3.3nF	-	27nF

Available capacitance values:  
 NPO, C4xx dielectrics: E6, E12, E24 [see page 14]. Specific values upon request.  
 X7R dielectric: E6, E12 in standard [see page 14]. Specific values upon request.  
 The above table defines the standard products, other components may be built upon request.



# High Voltage Conformal Coated Leded Capacitors

# TCF Series



**According to**  
Available space ranges:  
consult our detail  
specifications

## ELECTRICAL SPECIFICATIONS

DIELECTRIC	NPO	C4xx	X7R
<b>Dielectric code</b>	1	4	2
<b>Maximum <math>\Delta C/C</math> over temperature range without voltage</b>	NA	NA	$\pm 15\%$
<b>Temperature coefficient</b>	$(0 \pm 30)$ ppm/ $^{\circ}C$	$(-2,200 \pm 500)$ ppm/ $^{\circ}C$	NA
<b>Aging</b>	None	None	$\leq 2.5\%$ per decade hour
<b>Operating temperature</b>	$-55^{\circ}C$ to $+125^{\circ}C$		
<b>Rated voltage (<math>U_{RC}</math>)</b>	200 $V_{DC}$ to 10,000 $V_{DC}$	200 $V_{DC}$ to 5,000 $V_{DC}$	200 $V_{DC}$ to 10,000 $V_{DC}$
<b>Dielectric withstanding voltage</b>	2.5 $U_{RC}$ for $U_{RC} \leq 500 V_{DC}$ 1.6 $U_{RC}$ for $U_{RC} \geq 1,000 V_{DC}$ <b>Extended range:</b> 2 $U_{RC}$ for $U_{RC} \leq 500 V_{DC}$ 1.3 $U_{RC}$ for $U_{RC} \geq 1,000 V_{DC}$	2.5 $U_{RC}$ for $U_{RC} = 200 V_{DC}$ 2 $U_{RC}$ for $U_{RC} = 500 V_{DC}$ 1.5 $U_{RC}$ for $U_{RC} = 1,000 V_{DC}$ 1.4 $U_{RC}$ for $U_{RC} > 1,000 V_{DC}$ <b>Extended range:</b> 1.5 $U_{RC}$ for $U_{RC} \leq 500 V_{DC}$ 1.2 $U_{RC}$ for $U_{RC} \geq 1,000 V_{DC}$	2.5 $U_{RC}$ for $U_{RC} = 200 V_{DC}$ 2 $U_{RC}$ for $U_{RC} = 500 V_{DC}$ 1.5 $U_{RC}$ for $U_{RC} = 1,000 V_{DC}$ 1.2 $U_{RC}$ for $U_{RC} > 1,000 V_{DC}$ <b>Extended range:</b> 1.5 $U_{RC}$ for $U_{RC} \leq 500 V_{DC}$ 1.2 $U_{RC}$ for $U_{RC} \geq 1,000 V_{DC}$
<b>Capacitance</b>	at 1 MHz for $C \leq 1,000 pF$ at 1 kHz for $C > 1,000 pF$	at 1 kHz	at 1 kHz
<b>Dissipation factor</b>	$\leq 0.015 (150/C + 7)\%$ at 1 MHz for $C \leq 50 pF$ $\leq 0.15\%$ at 1 MHz for $50 pF < C \leq 1,000 pF$ $\leq 0.15\%$ at 1 kHz for $C > 1,000 pF$	$\leq 0.10\%$ at 1 kHz	$\leq 2.5\%$ at 1 kHz
<b>Insulation resistance at 25<math>^{\circ}C</math> under <math>U_{RC}</math> for <math>U_{RC} \leq 500 V</math> under 500 <math>V_{DC}</math> for <math>U_{RC} &gt; 500 V</math></b>	$\geq 100,000 M\Omega$ for $C \leq 10 nF$ $\geq 1,000 M\Omega \mu F$ for $C > 10 nF$	$\geq 20,000 M\Omega$ for $C \leq 25 nF$ $\geq 500 M\Omega \mu F$ for $C > 25 nF$	
<b>Voltage proof body insulation</b>	under $U_{RC}$ for $U_{RC} \leq 1,250 V_{DC}$ under 1,300 $V_{DC}$ for $U_{RC} > 1,250 V_{DC}$		

## FEATURES

- Multilayer chip ceramic capacitors
- NPO, C4xx and X7R dielectrics
- Capacitance range: 10 pF to 39  $\mu F$
- Voltage range: 200  $V_{DC}$  to 10,000  $V_{DC}$

## PHYSICAL CHARACTERISTICS

### CONSTRUCTION

Epoxy conformal coated radial leaded capacitors suited to through-hole circuits.

### MARKING

Series, capacitance value, tolerance, rated voltage, date code.

HIGH VOLTAGE

## HOW TO ORDER

TCF	1	82	W	F	680pF	10%	4,000 V	B
Series	Dielectric code	Exxelia size code	RoHS compliant	Quality level	Capacitance	Tolerance	Rated voltage	Reliability level
TCF = Conformal coated radial leaded capacitor	1 = NPO 2 = X7R 4 = C4xx	79	- = No RoHS W = RoHS compliant	- = standard quality level F = Hi-Rel quality: screening in accordance with Exxelia specification	Capacitance value in clear	NPO dielectric: $\pm 1\%$ $\pm 2\%$ $\pm 5\%$ $\pm 10\%$ $\pm 20\%$ C4xx dielectric: $\pm 2\%$ $\pm 5\%$ $\pm 10\%$ $\pm 20\%$ X7R dielectric: $\pm 10\%$ $\pm 20\%$	200 V 500 V 1,000 V 1,500 V 2,000 V 3,000 V 4,000 V 5,000 V 7,500 V 10,000 V  Intermediary and higher voltages available: contact your sales representative.	For F parts only. Acc. to Exxelia spec. - T5 T6  See page 15
		80						
		81						
		82						
		83						
		84						
		89						
		85						
		87						
		88						

# TCF Series

## High Voltage Conformal Coated Leaded Capacitors

### DIMENSIONS in inches (mm)

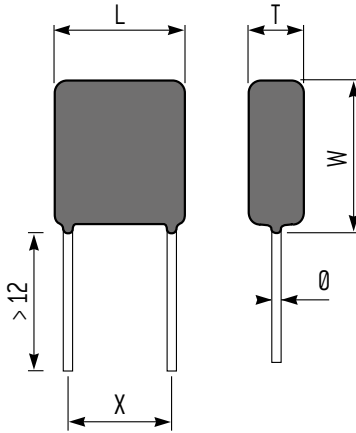

### STANDARD RATINGS

		Exxelia size code	78	79	90	80	91	81	82													
Dimensions inches (mm)	L max.		0.249 [6.3]	0.256 [6.5]	0.256 [6.5]	0.315 [8]	0.319 [8.1]	0.394 [10]	0.414 [10.5]													
	W max.		0.229 [5.8]	0.237 [6]	0.355 [9]	0.355 [9]	0.355 [9]	0.355 [9]	0.453 [11.5]													
	T max.		0.205 [5.2]	0.197 [5]	0.197 [5]	0.197 [5]	0.2kV up to 3kV: 0.237 [6] 4kV-5kV: 0.276 [?]	0.2kV up to 3kV: 0.237 [6] 4kV: 0.276 [?] 5kV: 0.315 [8]	0.2kV up to 3kV: 0.237 [6] 4kV: 0.276 [?] 5kV: 0.315 [8]													
	Ø ± 10%		0.024 [0.6]	0.024 [0.6]	0.024 [0.6]	0.024 [0.6]	0.024 [0.6]	0.031 [0.8]	0.031 [0.8]													
	X		0.2 ± 0.02 [5.08 ± 0.5]	0.2 ± 0.012 [5.08 ± 0.3]	0.2 ± 0.012 [5.08 ± 0.3]	0.2 ± 0.012 [5.08 ± 0.3]	0.2 ± 0.012 [5.08 ± 0.3]	0.2 ± 0.012 [5.08 ± 0.3]	0.3 ± 0.012 [7.62 ± 0.3]	0.4 ± 0.012 [10.16 ± 0.3]												
Dielectric		NPO	X7R	NPO	C4xx	X7R	NPO	C4xx	X7R	NPO	C4xx	X7R	NPO	C4xx	X7R	NPO	C4xx	X7R	NPO	C4xx	X7R	
Exxelia ceramic code		1	2	1	4	2	1	4	2	1	4	2	1	4	2	1	4	2	1	4	2	
Min. Capacitance value		12pF	120pF	10pF	27pF	100pF	10pF	33pF	150pF	10pF	33pF	150pF	15pF	47pF	150pF	18pF	56pF	150pF	33pF	82pF	330pF	
Rated voltage (U <sub>RC</sub> )	0.2kV	Standard	-	-	5.6nF	120nF	220nF	12nF	220nF	470nF	12nF	220nF	390nF	15nF	330nF	560nF	18nF	390nF	820nF	33nF	680nF	1.5µF
		Extended	-	-	18nF	-	470nF	27nF	-	-	22nF	-	1µF	39nF	-	-	56nF	-	1.8µF	100nF	-	2.7µF
	0.5kV	Standard	-	-	3.3nF	22nF	47nF	6.8nF	47nF	100nF	5.6nF	47nF	100nF	6.8nF	68nF	150nF	8.2nF	82nF	220nF	22nF	120nF	390nF
		Extended	-	-	10nF	39nF	150nF	18nF	68nF	-	18nF	68nF	270nF	22nF	100nF	-	27nF	120nF	560nF	68nF	220nF	1µF
	1kV	Standard	-	-	1.8nF	6.8nF	15nF	2.7nF	12nF	24nF	2.2nF	12nF	22nF	3.3nF	18nF	33nF	3.9nF	22nF	47nF	10nF	39nF	68nF
		Extended	820pF	12nF	5.6nF	10nF	27nF	8.2nF	15nF	-	6.8nF	15nF	56nF	10nF	22nF	-	12nF	27nF	120nF	33nF	56nF	220nF
	1.5kV	Standard	-	-	820pF	2.7nF	5.6nF	1.2nF	5.6nF	10nF	1.5nF	5.6nF	10nF	2.2nF	8.2nF	15nF	2.7nF	10nF	18nF	4.7nF	18nF	33nF
		Extended	-	-	1.5nF	3.9nF	12nF	2.2nF	8.2nF	-	2.2nF	6.8nF	22nF	3.3nF	12nF	-	4.7nF	15nF	47nF	8.2nF	27nF	82nF
	2kV	Standard	-	-	390pF	1.5nF	3.3nF	680pF	2.7nF	5.6nF	470pF	2.7nF	5.6nF	820pF	4.7nF	6.8nF	1.2nF	5.6nF	10nF	3.3nF	10nF	18nF
		Extended	470pF	2.7nF	820pF	2.2nF	5.6nF	1.2nF	3.9nF	-	1nF	3.9nF	12nF	1.8nF	6.8nF	-	2.7nF	8.2nF	27nF	6.8nF	15nF	47nF
	3kV	Standard	-	-	180pF	680pF	1.2nF	180pF	1.2nF	2.2nF	220pF	1.2nF	2.2nF	330pF	1.8nF	3.3nF	470pF	2.2nF	3.9nF	820pF	3.9nF	6.8nF
		Extended	220pF	1nF	390pF	1nF	2.7nF	680pF	1.8nF	-	470pF	1.8nF	4.7nF	820pF	2.7nF	-	1nF	3.3nF	12nF	1.8nF	5.6nF	22nF
4kV	Standard	-	-	100pF	330pF	680pF	120pF	680pF	1nF	150pF	820pF	1.2nF	220pF	1.2nF	1.8nF	390pF	1.5nF	2.7nF	680pF	3.3nF	4.7nF	
	Extended	150pF	470pF	220pF	560pF	-	330pF	1nF	-	330pF	1.2nF	2.2nF	680pF	1.8nF	-	820pF	2.2nF	4.7nF	1.5nF	4.7nF	10nF	
5kV	Standard	-	-	-	-	-	-	-	-	100pF	560pF	820pF	150pF	820pF	1nF	270pF	1nF	1.8nF	470pF	2.2nF	3.3nF	
	Extended	-	-	-	-	-	-	-	-	220pF	820pF	1.5nF	320pF	1.2nF	-	560pF	1.5nF	3.3nF	1nF	2.7nF	6.8nF	

Available capacitance values:  
 NPO, C4xx dielectrics: E6, E12, E24 (see page 14). Specific values upon request.  
 X7R dielectric: E6, E12 in standard (see page 14). Specific values upon request.  
 The above table defines the standard products, other components may be built upon request.

# High Voltage Conformal Coated Leaded Capacitors

# TCF Series

## STANDARD RATINGS

		Exxelia size code	83	84	89	85	87	88												
Dimensions inches (mm)	L max.		0.552 (14)	0.689 (17.5)	0.701 (17.8)	0.788 (20)	1.221 (31)	1.772 (45)												
	W max.		0.571 (14.5)	0.571 (14.5)	0.689 (17.5)	0.749 (19)	0.945 (24)	0.906 (23)												
	T max.		0.2kV up to 3kV: 0.237 (6) 4kV: 0.276 (7) 5kV up to 10kV: 0.315 (8)	0.2kV up to 3kV: 0.237 (6) 4kV: 0.276 (7) 5kV up to 10kV: 0.315 (8)	0.2kV up to 3kV: 0.237 (6) 4kV: 0.276 (7) 5kV up to 10kV: 0.315 (8)	0.2kV up to 3kV: 0.237 (6) 4kV: 0.276 (7) 5kV up to 10kV: 0.315 (8)	0.2kV up to 3kV: 0.237 (6) 4kV: 0.276 (7) 5kV: 0.315 (8) 7.5kV up to 10kV: 0.335 (8.5)	0.2kV up to 3kV: 0.237 (6) 4kV: 0.276 (7) 5kV: 0.315 (8) 7.5kV up to 10kV: 0.335 (8.5)												
	Ø ± 10%		0.031 (0.8)	0.031 (0.8)	0.031 (0.8)	0.031 (0.8)	0.039 (1)	0.039 (1)												
	X		0.5 ± 0.012 (12.7 ± 0.3)	0.6 ± 0.012 (15.24 ± 0.3)	0.6 ± 0.012 (15.24 ± 0.3)	0.7 ± 0.012 (17.8 ± 0.3)	1.1 ± 0.012 (27.94 ± 0.3)	1.6 ± 0.012 (40.64 ± 0.3)												
Dielectric		NPO	C4xx	X7R	NPO	C4xx	X7R	NPO	C4xx	X7R	NPO	C4xx	X7R	NPO	C4xx	X7R	NPO	C4xx	X7R	
Exxelia ceramic code		1	4	2	1	4	2	1	4	2	1	4	2	1	4	2	1	4	2	
Min. Capacitance value		10pF	180pF	270pF	22pF	270pF	390pF	27pF	390pF	560pF	47pF	470pF	1nF	120pF	1nF	2.2nF	150pF	1.8nF	2.7nF	
Rated voltage (U <sub>DC</sub> )	0.2kV	Standard	56nF	1.2µF	2.7µF	82nF	1.5µF	3.9µF	100nF	1.8µF	4.7µF	180nF	2.7µF	6.8µF	330nF	6.8µF	12µF	390nF	8.2µF	15µF
		Extended	180nF	-	5.6µF	270nF	-	6.8µF	220nF	-	8.2µF	560nF	-	12µF	1µF	-	33µF	1.2µF	-	39µF
	0.5kV	Standard	33nF	270nF	680nF	47nF	330nF	1µF	56nF	390nF	1.2µF	82nF	680nF	1.8µF	150nF	1.5µF	3.9µF	270nF	1.8µF	4.7µF
		Extended	100nF	390nF	1.5µF	150nF	560nF	2.2µF	150nF	680nF	2.7µF	270nF	1µF	3.9µF	470nF	2.2µF	10µF	820nF	2.7µF	12µF
	1kV	Standard	15nF	82nF	150nF	22nF	82nF	220nF	33nF	120nF	270nF	39nF	220nF	390nF	82nF	560nF	1µF	150nF	680nF	1.2µF
		Extended	47nF	120nF	390nF	68nF	120nF	560nF	82nF	220nF	560nF	120nF	330nF	1µF	270nF	680nF	2.7µF	470nF	1µF	3.3µF
	1.5kV	Standard	8.2nF	39nF	82nF	12nF	39nF	100nF	15nF	68nF	150nF	22nF	100nF	180nF	47nF	220nF	470nF	68nF	330nF	560nF
		Extended	18nF	56nF	180nF	22nF	56nF	220nF	33nF	100nF	330nF	47nF	150nF	470nF	100nF	330nF	1.2µF	150nF	470nF	1.5µF
	2kV	Standard	4.7nF	18nF	33nF	6.8nF	22nF	68nF	8.2nF	39nF	68nF	12nF	56nF	100nF	27nF	120nF	220nF	39nF	180nF	330nF
		Extended	10nF	27nF	100nF	15nF	33nF	150nF	18nF	56nF	150nF	27nF	82nF	220nF	56nF	180nF	560nF	82nF	270nF	820nF
	3kV	Standard	1.5nF	8.2nF	15nF	2.7nF	10nF	27nF	3.3nF	18nF	27nF	4.7nF	27nF	39nF	12nF	56nF	100nF	15nF	68nF	120nF
		Extended	3.3nF	12nF	39nF	5.6nF	15nF	56nF	10nF	22nF	68nF	10nF	39nF	100nF	27nF	82nF	270nF	33nF	100nF	330nF
	4kV	Standard	1.2nF	6.8nF	10nF	2.2nF	6.8nF	15nF	2.7nF	12nF	18nF	3.9nF	18nF	27nF	10nF	39nF	68nF	12nF	47nF	100nF
		Extended	2.7nF	10nF	18nF	4.7nF	10nF	27nF	6.8nF	18nF	39nF	8.2nF	27nF	47nF	22nF	56nF	120nF	27nF	82nF	150nF
	5kV	Standard	1nF	4.7nF	5.6nF	1.8nF	4.7nF	10nF	1.8nF	8.2nF	12nF	3.3nF	12nF	18nF	8.2nF	27nF	56nF	10nF	33nF	68nF
		Extended	2.2nF	6.8nF	15nF	3.9nF	6.8nF	22nF	4.7nF	12nF	27nF	6.8nF	18nF	39nF	15nF	39nF	82nF	18nF	47nF	100nF
	7.5kV	Standard	150pF	-	1.5nF	270pF	-	2.7nF	470pF	-	3.3nF	560pF	-	6.8nF	1.5nF	-	18nF	2.2nF	-	27nF
		Extended	330pF	-	3.3nF	560pF	-	5.6nF	1.2nF	-	6.8nF	1.2nF	-	12nF	3.3nF	-	33nF	4.7nF	-	47nF
	10kV	Standard	100pF	-	680pF	180pF	-	1.2nF	270pF	-	1.5nF	390pF	-	3.3nF	1nF	-	8.2nF	1.5nF	-	12nF
		Extended	220pF	-	1.8nF	390pF	-	3.3nF	680pF	-	3.9nF	820pF	-	6.8nF	2.2nF	-	15nF	3.3nF	-	27nF

Available capacitance values:

NPO, C4xx dielectrics: E6, E12, E24 (see page 14). Specific values upon request.

X7R dielectric: E6, E12 in standard (see page 14). Specific values upon request.

The above table defines the standard products, other components may be built upon request.

HIGH VOLTAGE

# TKD Series

## High Voltage Conformal Coated Led Capacitors



**According to**  
Available space ranges:  
consult our detail  
specifications

### ELECTRICAL SPECIFICATIONS

DIELECTRIC	NPO	C4xx	X7R
<b>Dielectric code</b>	<b>1</b>	<b>4</b>	<b>2</b>
<b>Maximum <math>\Delta C/^\circ C</math> over temperature range without voltage</b>	NA	NA	$\pm 15\%$
<b>Temperature coefficient</b>	$(0 \pm 30)$ ppm/ $^\circ C$	$(-2,200 \pm 500)$ ppm/ $^\circ C$	NA
<b>Aging</b>	None	None	$\leq 2.5\%$ per decade hour
<b>Operating temperature</b>	$-55^\circ C$ to $+125^\circ C$		
<b>Rated voltage (<math>U_{RC}</math>)</b>	250 $V_{DC}$ to 10,000 $V_{DC}$	250 $V_{DC}$ to 5,000 $V_{DC}$	250 $V_{DC}$ to 10,000 $V_{DC}$
<b>Dielectric withstanding voltage</b>	2.5 $U_{RC}$ for $U_{RC} \leq 500 V_{DC}$ 1.6 $U_{RC}$ for $U_{RC} \geq 1,000 V_{DC}$ <b>Extended range:</b> 2 $U_{RC}$ for $U_{RC} \leq 500 V_{DC}$ 1.3 $U_{RC}$ for $U_{RC} \geq 1,000 V_{DC}$	2.5 $U_{RC}$ for $U_{RC} = 250 V_{DC}$ 2 $U_{RC}$ for $U_{RC} = 500 V_{DC}$ 1.5 $U_{RC}$ for $U_{RC} = 1,000 V_{DC}$ 1.4 $U_{RC}$ for $U_{RC} > 1,000 V_{DC}$ <b>Extended range:</b> 1.5 $U_{RC}$ for $U_{RC} \leq 500 V_{DC}$ 1.2 $U_{RC}$ for $U_{RC} \geq 1,000 V_{DC}$	2.5 $U_{RC}$ for $U_{RC} = 250 V_{DC}$ 2 $U_{RC}$ for $U_{RC} = 500 V_{DC}$ 1.5 $U_{RC}$ for $U_{RC} = 1,000 V_{DC}$ 1.2 $U_{RC}$ for $U_{RC} > 1,000 V_{DC}$ <b>Extended range:</b> 1.5 $U_{RC}$ for $U_{RC} \leq 500 V_{DC}$ 1.2 $U_{RC}$ for $U_{RC} \geq 1,000 V_{DC}$
<b>Capacitance</b>	at 1 MHz for $C \leq 1,000 pF$ at 1 kHz for $C > 1,000 pF$	at 1 kHz	at 1 kHz
<b>Dissipation factor</b>	$\leq 0.015 (150/C + 7)\%$ at 1 MHz for $C \leq 50 pF$ $\leq 0.15\%$ at 1 MHz for $50 pF < C \leq 1,000 pF$ $\leq 0.15\%$ at 1 kHz for $C > 1,000 pF$	$\leq 0.1\%$ at 1 kHz	$\leq 2.5\%$ at 1 kHz
<b>Insulation resistance at 25<math>^\circ C</math> under <math>U_{RC}</math> for <math>U_{RC} \leq 500 V</math> under 500 <math>V_{DC}</math> for <math>U_{RC} &gt; 500 V</math></b>	$\geq 100,000 M\Omega$ for $C \leq 10 nF$ $\geq 1,000 M\Omega \mu F$ for $C > 10 nF$	$\geq 20,000 M\Omega$ for $C \leq 25 nF$ $\geq 500 M\Omega \mu F$ for $C > 25 nF$	
<b>Voltage proof body insulation</b>	under $U_{RC}$ for $U_{RC} \leq 1,250 V_{DC}$ under 1,300 $V_{DC}$ for $U_{RC} > 1,250 V_{DC}$		

### FEATURES

- Multilayer chip ceramic capacitors
- NPO, C4xx and X7R dielectrics
- Capacitance range: 10 pF to 39  $\mu F$
- Voltage range: 250  $V_{DC}$  to 10,000  $V_{DC}$

### PHYSICAL CHARACTERISTICS

#### CONSTRUCTION

Epoxy conformal coated radial leaded capacitors suited to through-hole circuits.

#### MARKING

Series, capacitance value, tolerance, rated voltage, date code.

### DIMENSIONS in inches (mm)

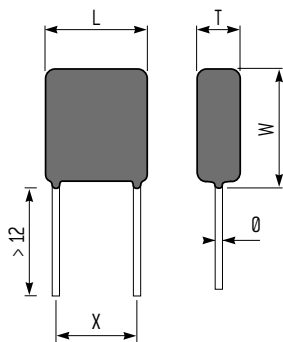

### HOW TO ORDER

TKD	1	82	W	F	680pF	10%	4,000 V	B
Series	Dielectric code	Exxelia size code	RoHS compliant	Quality level	Capacitance	Tolerance	Rated voltage	Reliability level
TKD = Conformal coated radial leaded capacitor	1 = NPO 2 = X7R 4 = C4xx	79 90 80 91 81 82 83 84 89 85 87 88	- = No RoHS W = RoHS compliant	- = standard quality level F = Hi-Rel quality: screening in accordance with Exxelia specification	Capacitance value in clear	<u>NPO dielectric:</u> $\pm 1\%$ $\pm 2\%$ $\pm 5\%$ $\pm 10\%$ $\pm 20\%$ <u>C4xx dielectric:</u> $\pm 2\%$ $\pm 5\%$ $\pm 10\%$ $\pm 20\%$ <u>X7R dielectric:</u> $\pm 10\%$ $\pm 20\%$	200 V 500 V 1,000 V 1,500 V 2,000 V 3,000 V 4,000 V 5,000 V 7,500 V 10,000 V Intermediary and higher voltages available: contact your sales representative.	For F parts only. Acc. to Exxelia spec. - T5 T6 See page 15

## High Voltage Conformal Coated Leaded Capacitors

# TKD Series

### STANDARD RATINGS

		Exxelia size code			79			90			80			91			81			82																										
Dimensions inches (mm)	L max.	0.25 (6.35)			0.256 (6.5)			0.319 (8.1)			0.319 (8.1)			0.371 (9.4)			0.469 (11.9)																													
	W max.	0.221 (5.6)			0.355 (9)			0.296 (7.5)			0.355 (9)			0.327 (8.3)			0.414 (10.5)																													
	T max.	0.197 (5)			0.217 (5.5)			0.25 (6.35)			0.25 (6.35)			0.25 (6.35)			0.25 (6.35)																													
	$\emptyset \pm 10\%$	0.024 (0.6)			0.024 (0.6)			0.024 (0.6)			0.024 (0.6)			0.024 (0.6)			0.024 (0.6)																													
	X	0.169 ± 0.020 (4.3 ± 0.5)			0.169 ± 0.020 (4.3 ± 0.5)			0.220 ± 0.020 (5.6 ± 0.5)			0.220 ± 0.020 (5.6 ± 0.5)			0.276 ± 0.020 (7.0 ± 0.5)			0.374 ± 0.020 (9.5 ± 0.5)																													
Dielectric		NPO			C4xx			X7R			NPO			C4xx			X7R			NPO			C4xx			X7R																				
Exxelia ceramic code		1			4			2			1			4			2			1			4			2																				
Min. Capacitance value		10pF			27pF			100pF			10pF			33pF			150pF			15pF			47pF			150pF			18pF			56pF			150pF			33pF			82pF			330pF		
Rated voltage ( $U_{DC}$ )	0.2kV	Standard	5.6nF	100nF	220nF	12nF	180nF	470nF	12nF	33pF	150pF	15nF	330nF	560nF	18nF	270nF	820nF	33nF	560nF	1.5µF																										
		Extended	15nF	-	470nF	27nF	-	-	22nF	-	1µF	39nF	-	-	47nF	-	1.8µF	82nF	-	2.7µF																										
	0.5kV	Standard	3.3nF	22nF	47nF	6.8nF	47nF	100nF	5.6nF	47nF	100nF	6.8nF	68nF	150nF	8.2nF	82nF	220nF	22nF	120nF	390nF																										
		Extended	10nF	39nF	150nF	18nF	68nF	-	18nF	68nF	270nF	22nF	100nF	-	27nF	120nF	560nF	68nF	220nF	1µF																										
	1kV	Standard	1.8nF	6.8nF	15nF	2.7nF	12nF	24nF	2.2nF	12nF	22nF	3.3nF	18nF	33nF	3.9nF	22nF	47nF	10nF	10nF	39nF	68nF																									
		Extended	5.6nF	10nF	27nF	8.2nF	15nF	-	6.8nF	15nF	56nF	10nF	22nF	-	12nF	27nF	120nF	33nF	56nF	220nF																										
	1.5kV	Standard	820pF	2.7nF	5.6nF	1.2nF	5.6nF	10nF	1.5nF	5.6nF	10nF	2.2nF	8.2nF	15nF	2.7nF	10nF	18nF	4.7nF	18nF	33nF																										
		Extended	1.5nF	3.9nF	12nF	2.2nF	8.2nF	-	2.2nF	6.8nF	22nF	3.3nF	12nF	-	4.7nF	15nF	47nF	8.2nF	27nF	82nF																										
	2kV	Standard	390pF	1.5nF	3.3nF	680pF	2.7nF	5.6nF	470pF	2.7nF	5.6nF	820pF	4.7nF	6.8nF	1.2nF	5.6nF	10nF	3.3nF	10nF	18nF																										
		Extended	820pF	2.2nF	5.6nF	1.2nF	3.9nF	-	1nF	3.9nF	12nF	1.8nF	6.8nF	-	2.7nF	8.2nF	27nF	6.8nF	15nF	47nF																										
	3kV	Standard	180pF	680pF	1.2nF	180pF	1.2nF	2.2nF	220pF	1.2nF	2.2nF	330pF	1.8nF	3.3nF	470pF	2.2nF	3.9nF	820pF	3.9nF	6.8nF																										
		Extended	390pF	1nF	2.7nF	680pF	1.8nF	-	470pF	1.8nF	4.7nF	820pF	2.7nF	-	1nF	3.3nF	12nF	1.8nF	5.6nF	22nF																										
	4kV	Standard	100pF	330pF	680pF	120pF	680pF	1nF	150pF	820pF	1.2nF	220pF	1.2nF	1.8nF	330pF	1.5nF	2.7nF	560pF	2.7nF	4.7nF																										
		Extended	220pF	560pF	-	330pF	1nF	-	330pF	1.2nF	2.2nF	680pF	1.8nF	-	820pF	2.2nF	4.7nF	1.5nF	3.9nF	10nF																										
5kV	Standard	-	-	-	-	-	-	100pF	560pF	820pF	150pF	820pF	1nF	220pF	820pF	1.5nF	390pF	1.8nF	2.7nF																											
	Extended	-	-	-	-	-	-	220pF	820pF	1.5nF	320pF	1.2nF	-	560pF	1.2nF	3.3nF	1nF	2.7nF	5.6nF																											

HIGH VOLTAGE

		Exxelia size code			83			84			89			85			87			88																				
Dimensions inches (mm)	L max.	0.569 (14.45)			0.67 (17)			0.701 (17.8)			0.77 (19.55)			1.221 (31)			1.772 (45)																							
	W max.	0.504 (12.8)			0.552 (14)			0.689 (17.5)			0.749 (19)			0.945 (24)			0.906 (23)																							
	T max.	0.27 (6.85)			0.27 (6.85)			0.27 (6.85)			0.27 (6.85)			0.27 (6.85)			0.27 (6.85)																							
	$\emptyset \pm 10\%$	0.024 (0.6)			0.024 (0.6)			0.024 (0.6)			0.024 (0.6)			0.024 (0.6)			0.024 (0.6)																							
	X	0.472 ± 0.020 (12.0 ± 0.5)			0.575 ± 0.020 (14.6 ± 0.5)			0.575 ± 0.020 (14.6 ± 0.5)			0.673 ± 0.020 (17.1 ± 0.5)			1.083 ± 0.020 (27.5 ± 0.5)			1.583 ± 0.020 (40.2 ± 0.5)																							
Dielectric		NPO			C4xx			X7R			NPO			C4xx			X7R			NPO			C4xx			X7R														
Exxelia ceramic code		1			4			2			1			4			2			1			4			2														
Min. Capacitance value		10pF			180pF			270pF			27pF			390pF			47pF			1nF			120pF			1nF			2.2nF			150pF			1.8nF			2.2nF		
Rated voltage ( $U_{DC}$ )	0.2kV	Standard	56nF	1µF	2.7µF	82nF	1.2µF	3.9µF	100nF	1.5µF	4.7µF	180nF	2.7µF	6.8µF	330nF	5.6µF	12µF	390nF	8.2µF	15µF																				
		Extended	180nF	-	5.6µF	220nF	-	6.8µF	220nF	-	8.2µF	470nF	-	12µF	1µF	-	33µF	1.2µF	-	39µF																				
	0.5kV	Standard	33nF	270nF	680nF	47nF	330nF	1µF	56nF	390nF	1.2µF	82nF	680nF	1.8µF	150nF	1.5µF	3.9µF	270nF	1.8µF	4.7µF																				
		Extended	100nF	390nF	1.5µF	150nF	560nF	2.2µF	150nF	680nF	2.7µF	270nF	1µF	3.9µF	470nF	2.2µF	10µF	820nF	2.7µF	12µF																				
	1kV	Standard	15nF	82nF	150nF	22nF	82nF	220nF	33nF	120nF	270nF	39nF	220nF	390nF	82nF	560nF	1µF	150nF	680nF	1.2µF																				
		Extended	47nF	120nF	390nF	68nF	120nF	560nF	82nF	220nF	560nF	120nF	330nF	1µF	270nF	680nF	2.7µF	470nF	1µF	3.3µF																				
	1.5kV	Standard	8.2nF	39nF	82nF	12nF	39nF	100nF	15nF	68nF	150nF	22nF	100nF	180nF	47nF	220nF	470nF	68nF	330nF	560nF																				
		Extended	18nF	56nF	180nF	22nF	56nF	220nF	33nF	100nF	330nF	47nF	150nF	470nF	100nF	330nF	1.2µF	150nF	470nF	1.5µF																				
	2kV	Standard	4.7nF	18nF	33nF	6.8nF	22nF	68nF	8.2nF	39nF	68nF	12nF	56nF	100nF	27nF	120nF	220nF	39nF	180nF	330nF																				
		Extended	10nF	27nF	100nF	15nF	33nF	150nF	18nF	56nF	150nF	27nF	82nF	220nF	56nF	180nF	560nF	82nF	270nF	820nF																				
	3kV	Standard	1.5nF	8.2nF	15nF	2.7nF	10nF	27nF	3.3nF	18nF	27nF	4.7nF	27nF	39nF	12nF	56nF	100nF	15nF	68nF	120nF																				
		Extended	3.3nF	12nF	39nF	5.6nF	15nF	56nF	10nF	22nF	68nF	10nF	39nF	100nF	27nF	82nF	270nF	33nF	100nF	330nF																				
	4kV	Standard	1.2nF	5.6nF	10nF	2.2nF	6.8nF	15nF	2.7nF	12nF	18nF	3.9nF	15nF	27nF	8.2nF	39nF	68nF	12nF	47nF	100nF																				
		Extended	2.7nF	8.2nF	18nF	4.7nF	10nF	27nF	6.8nF	18nF	39nF	8.2nF	22nF	47nF	22nF	56nF	120nF	27nF	82nF	150nF																				
5kV	Standard	1nF	3.9nF	5.6nF	1.8nF	4.7nF	10nF	1.8nF	8.2nF	12nF	3.3nF	12nF	18nF	6.8nF	22nF	56nF	6.8nF	33nF	68nF																					
	Extended	2.2nF	5.6nF	15nF	3.3nF	6.8nF	22nF	4.7nF	12nF	27nF	6.8nF	18nF	39nF	15nF	33nF	68nF	18nF	47nF	100nF																					
7.5kV	Standard	150pF	-	1.5nF	270pF	-	2.7nF	470pF	-	3.3nF	560pF	-	6.8nF	1.5nF	-	15nF	2.2nF	-	27nF																					
	Extended	330pF	-	3.3nF	560pF	-	5.6nF	1.2nF	-	6.8nF	1.2nF	-	12nF	3.3nF	-	33nF	4.7nF	-	47nF																					
10kV	Standard	100pF	-	680pF	180pF	-	1.2nF	270pF	-	1.5nF	390pF	-	3.3nF	1nF	-	8.2nF	1.5nF	-	12nF																					
	Extended	220pF	-	1.8nF	390pF	-	3.3nF	680pF	-	3.9nF	820pF	-	6.8nF	2.2nF	-	15nF	3.3nF	-	22nF																					

Available capacitance values:

NPO, C4xx dielectrics: E6, E12, E24 (see page 14). Specific values upon request.

X7R dielectric: E6, E12 in standard (see page 14). Specific values upon request.

The above table defines the standard products, other components may be built upon request.

# CS Series

## High Voltage Stacked Capacitors



### FEATURES

- Multilayer chip ceramic capacitors stacked
- NPO, C4xx and X7R dielectrics
- Capacitance range: 220 pF to 15 μF
- Voltage range: 1,000 V<sub>DC</sub> to 10,000 V<sub>DC</sub>

### PHYSICAL CHARACTERISTICS

#### CONSTRUCTION

- **P, PL, L models:** DIL leaded uncoated stacked chip capacitors for surface mounting recommended to eliminate thermomechanical stresses.
- **N, NU models:** DIL leaded stacked chip capacitors for through-hole circuits (N: varnished chips, NU: uncoated chips).
- **R, RU models:** Ribbon leaded stacked chip capacitors for surface mounting (R: varnished chips, RU: uncoated chips) recommended to eliminate thermomechanical stresses.

#### RECOMMENDED FOOTPRINT

See general information on high voltage capacitors (see page 50).

#### MARKING

Series, capacitance value, tolerance, rated voltage, date code.

### ELECTRICAL SPECIFICATIONS

DIELECTRIC	NPO	C4xx	X7R
Dielectric code	1	4	2
<b>Maximum ΔC/°C over temperature range without voltage</b>	NA	NA	± 15%
<b>Temperature coefficient</b>	(0 ± 30) ppm/°C	(-2,200 ± 500) ppm/°C	NA
<b>Aging</b>	None	None	≤ 2.5% per decade hour
<b>Operating temperature</b>	-55°C to +125°C		
<b>Rated voltage (U<sub>RC</sub>)</b>	1,000 V <sub>DC</sub> to 10,000 V <sub>DC</sub>	1,000 V <sub>DC</sub> to 5,000 V <sub>DC</sub>	1,000 V <sub>DC</sub> to 10,000 V <sub>DC</sub>
<b>Dielectric withstanding voltage</b>	1.3 U <sub>RC</sub>	1.2 U <sub>RC</sub>	1.2 U <sub>RC</sub>
<b>Capacitance</b>	at 1 MHz for C ≤ 1,000 pF at 1 kHz for C > 1,000 pF	at 1 kHz	at 1 kHz
<b>Dissipation factor</b>	≤ 0.15% at 1 MHz for C ≤ 1,000 pF ≤ 0.15% at 1 kHz for C > 1,000 pF	≤ 0.10% at 1 kHz	≤ 2.5% at 1 kHz
<b>Insulation resistance at 25°C under U<sub>RC</sub> for U<sub>RC</sub> ≤ 500 V under 500 V<sub>DC</sub> for U<sub>RC</sub> &gt; 500 V</b>	≥ 100,000 MΩ for C ≤ 10 nF ≥ 1,000 MΩ·μF for C > 10 nF	≥ 20,000 MΩ for C ≤ 25 nF ≥ 500 MΩ·μF for C > 25 nF	

### HOW TO ORDER

CS	2	84	P	W	F	120nF	20%	2,000 V	-
Series	Dielectric code	Exxelia size code	Leads style	RoHS compliant	Quality level	Capacitance	Tolerance	Rated voltage	Reliability level
CS = High voltage stacked capacitor	1 = NPO 2 = X7R 4 = C4xx	80 81 82 83 84 89 85 87 88	P PL L R RU N NU	- = No RoHS W = RoHS compliant	- = standard quality level F = Hi-Rel quality: screening in accordance with Exxelia specification	Capacitance value in clear	NPO dielectric: ± 1% ± 2% ± 5% ± 10% ± 20% C4xx dielectric: ± 2% ± 5% ± 10% ± 20% X7R dielectric: ± 10% ± 20%	1,000 V 1,500 V 2,000 V 3,000 V 4,000 V 5,000 V 7,500 V 10,000 V Intermediary, lower and higher voltages available: contact your sales representative.	For F parts only. Acc. to Exxelia spec. - T5 T6 See page 15

# High Voltage Stacked Capacitors

# CS Series

## DIMENSIONS in inches (mm)

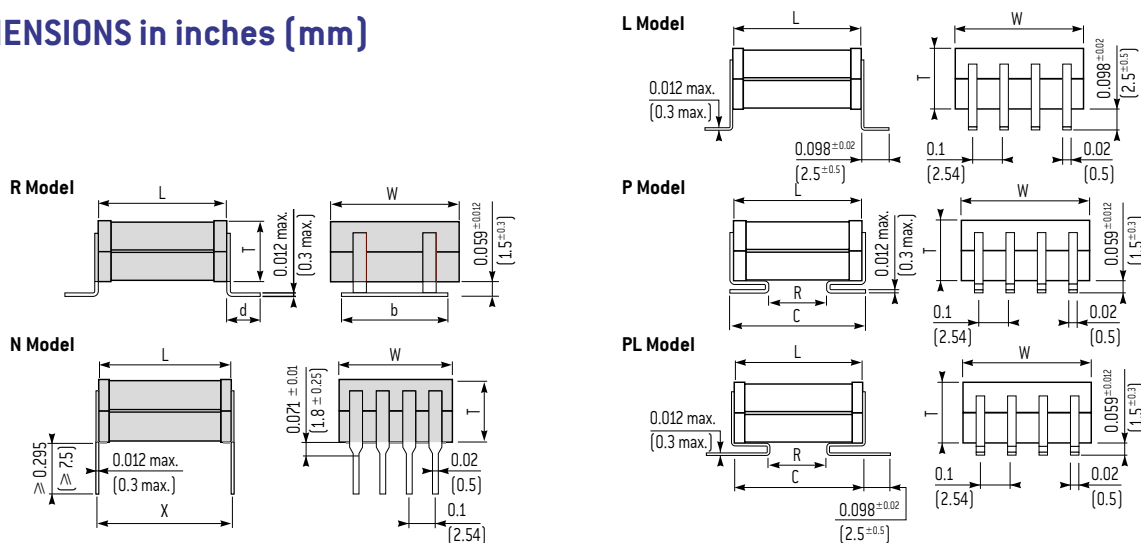

## STANDARD RATINGS

Size	2220			2825			3333			4040			T max. inches [mm]	Nb. of chips
	Exxelia size code	80	81	82	83									
L	0.224 ± 0.020 (5.7 ± 0.5)	0.276 ± 0.020 (7 ± 0.5)	0.331 ± 0.020 (8.4 ± 0.5)	0.400 ± 0.039 (10.16 ± 1)										
W	0.197 ± 0.020 (5.0 ± 0.5)	0.250 ± 0.020 (6.35 ± 0.5)	0.331 ± 0.020 (8.4 ± 0.5)	0.400 ± 0.039 (10.16 ± 1)										
d	0.087 ± 0.008 (2.2 ± 0.2)	0.087 ± 0.008 (2.2 ± 0.2)	0.138 ± 0.008 (3.5 ± 0.2)	0.138 ± 0.008 (3.5 ± 0.2)										
b	0.197 ± 0.020 (5 ± 0.5)	0.197 ± 0.020 (5 ± 0.5)	0.315 ± 0.020 (8 ± 0.5)	0.315 ± 0.020 (8 ± 0.5)										
R min.	0.098 (2.5)	0.137 (3.5)	0.177 (4.5)	0.275 (7)										
C max.	0.276 (7)	0.315 (8)	0.355 (9)	0.473 (12)										
X	0.248 ± 0.020 (6.3 ± 0.5)	0.300 ± 0.020 (7.62 ± 0.5)	0.350 ± 0.020 (8.9 ± 0.5)	0.45 ± 0.020 (11.43 ± 0.5)										
Leads per side	2	2	3	4										

Dielectric	NPO			C4xx			X7R			T max. inches [mm]	Nb. of chips				
	1	4	2	1	4	2	1	4	2						
Exxelia ceramic code	1	4	2	1	4	2	1	4	2						
Min. Capacitance value	220pF	820pF	1.5nF	560pF	1.5nF	3.3nF	1nF	2.7nF	6.8nF	220pF	6.8nF	1.8nF			
Rated voltage (U <sub>DC</sub> )	1kV	12nF	39nF	100nF	18nF	56nF	180nF	39nF	100nF	270nF	68nF	220nF	560nF	0.394 (10)	2
		18nF	68nF	150nF	27nF	82nF	270nF	56nF	150nF	390nF	100nF	330nF	1µF	0.591 (15)	3
		-	-	-	-	-	-	-	-	-	-	-	-	0.788 (20)	4
	1.5kV	5.6nF	18nF	39nF	8.2nF	27nF	68nF	22nF	56nF	120nF	39nF	100nF	270nF	0.394 (10)	2
		8.2nF	27nF	56nF	12nF	39nF	100nF	33nF	68nF	180nF	56nF	150nF	390nF	0.591 (15)	3
		-	-	-	-	-	-	-	-	-	-	-	-	0.788 (20)	4
	2kV	3.3nF	10nF	22nF	4.7nF	18nF	39nF	8.2nF	27nF	68nF	18nF	56nF	150nF	0.394 (10)	2
		4.7nF	15nF	33nF	6.8nF	27nF	68nF	12nF	39nF	120nF	27nF	82nF	220nF	0.591 (15)	3
		-	-	-	-	-	-	-	-	-	-	-	-	0.788 (20)	4
	3kV	2.2nF	4.7nF	12nF	2.7nF	6.8nF	18nF	4.7nF	12nF	33nF	10nF	27nF	68nF	0.394 (10)	2
		3.3nF	6.8nF	18nF	3.9nF	10nF	27nF	6.8nF	22nF	47nF	15nF	39nF	100nF	0.591 (15)	3
		-	-	-	-	-	-	-	-	-	-	-	-	0.788 (20)	4
	4kV	1nF	2.7nF	5.6nF	1.8nF	3.3nF	12nF	3.3nF	6.8nF	22nF	5.6nF	15nF	39nF	0.394 (10)	2
		1.5nF	3.9nF	8.2nF	2.7nF	4.7nF	18nF	4.7nF	10nF	33nF	8.2nF	22nF	56nF	0.591 (15)	3
		-	-	-	-	-	-	-	-	-	-	-	-	0.788 (20)	4
	5kV	560pF	1.5nF	3.9nF	1.2nF	2.2nF	8.2nF	2.2nF	3.9nF	12nF	3.9nF	8.2nF	27nF	0.394 (10)	2
		820pF	2.7nF	5.6nF	1.8nF	3.3nF	12nF	3.3nF	5.6nF	18nF	5.6nF	12nF	39nF	0.591 (15)	3
		-	-	-	-	-	-	-	-	-	-	-	-	0.788 (20)	4
	7.5kV	-	-	-	-	-	-	-	-	-	-	-	-	0.985 (25)	5
		-	-	-	-	-	-	-	-	-	820pF	-	8.2nF	0.394 (10)	2
		-	-	-	-	-	-	-	-	-	1.2nF	-	12nF	0.591 (15)	3
	10kV	-	-	-	-	-	-	-	-	-	-	-	-	0.788 (20)	4
		-	-	-	-	-	-	-	-	-	-	-	-	0.985 (25)	5
		-	-	-	-	-	-	-	-	-	560pF	-	4.7nF	0.394 (10)	2
-	-	-	-	-	-	-	-	-	820pF	-	6.8nF	0.591 (15)	3		
-	-	-	-	-	-	-	-	-	-	-	-	0.788 (20)	4		
-	-	-	-	-	-	-	-	-	-	-	-	0.985 (25)	5		

HIGH VOLTAGE

### STANDARD RATINGS

Size	5440			5550			6560			11283			16080						
Exxelia size code	84			89			85			87			88						
Dimensions inches (mm)	L	0.539 ± 0.039 (13.7 ± 1)			0.551 ± 0.039 (14 ± 1)			0.650 ± 0.039 (16.5 ± 1)			1.122 ± 0.039 (28.5 ± 1)			1.555 ± 0.039 (39.5 ± 1)					
	W	0.400 ± 0.039 (10.16 ± 1)			0.500 ± 0.039 (12.7 ± 1)			0.598 ± 0.039 (15.2 ± 1)			0.827 ± 0.039 (21 ± 1)			0.756 ± 0.039 (19.2 ± 1)					
	d	0.138 ± 0.008 (3.5 ± 0.2)			0.138 ± 0.008 (3.5 ± 0.2)			0.138 ± 0.008 (3.5 ± 0.2)			0.138 ± 0.008 (3.5 ± 0.2)			0.138 ± 0.008 (3.5 ± 0.2)					
	b	0.315 ± 0.020 (8 ± 0.5)			0.315 ± 0.020 (8 ± 0.5)			0.591 ± 0.020 (15 ± 0.5)			0.591 ± 0.020 (15 ± 0.5)			0.591 ± 0.020 (15 ± 0.5)					
	R min.	0.393 (10)			0.393 (10)			0.511 (13)			0.984 (25)			1.377 (35)					
	C max.	0.611 (15.5)			0.63 (16)			0.729 (18.5)			1.26 (32)			1.654 (42)					
	X	0.552 ± 0.020 (14 ± 0.5)			0.563 ± 0.020 (14.3 ± 0.5)			0.7 ± 0.020 (17.78 ± 0.5)			1.15 ± 0.020 (29.21 ± 0.5)			1.6 ± 0.020 (40.64 ± 0.5)					
Leads per side	4			5			6			6			6						
Dielectric	NPO	C4xx	X7R	NPO	C4xx	X7R	NPO	C4xx	X7R	NPO	C4xx	X7R	NPO	C4xx	X7R	T max. inches (mm)	Nb. of chips		
Exxelia ceramic code	1	4	2	1	4	2	1	4	2	1	4	2	1	4	2				
Min Capacitance value	390pF	6.8nF	3.3nF	680pF	12nF	3.9nF	820pF	18nF	6.8nF	2.2nF	39nF	15nF	3.3nF	47nF	27nF				
Rated voltage (U <sub>rated</sub> )	1kV	100nF	270nF	820nF	120nF	390nF	1µF	220nF	560nF	1.8µF	470nF	1.5µF	3.9µF	560nF	1.8µF	5.6µF	0.394	(10)	2
		150nF	390nF	1.2µF	180nF	560nF	1.5µF	330nF	820nF	2.7µF	680nF	2.2µF	5.6µF	820nF	2.2µF	8.2µF	0.591	(15)	3
		220nF	560nF	1.8µF	270nF	820nF	2.2µF	470nF	1.2µF	3.3µF	1µF	3.3µF	6.8µF	1.2µF	3.9µF	10µF	0.788	(20)	4
		-	-	-	330nF	1µF	2.7µF	560nF	1.5µF	3.9µF	1.2µF	3.9µF	10µF	1.5µF	4.7µF	15µF	0.985	(25)	5
	1.5kV	47nF	120nF	390nF	68nF	180nF	470nF	100nF	270nF	680nF	270nF	680nF	1.5µF	330nF	820nF	2.2µF	0.394	(10)	2
		68nF	180nF	560nF	100nF	270nF	680nF	150nF	390nF	1µF	390nF	1µF	2.2µF	470nF	1.2µF	3.3µF	0.591	(15)	3
		100nF	270nF	820nF	150nF	390nF	1µF	220nF	560nF	1.5µF	560nF	1.5µF	2.7µF	680nF	1.8µF	4.7µF	0.788	(20)	4
		-	-	-	180nF	470nF	1.2µF	270nF	680nF	1.8µF	680nF	1.8µF	3.9µF	820nF	2.2µF	5.6µF	0.985	(25)	5
	2kV	27nF	68nF	220nF	33nF	100nF	270nF	47nF	150nF	390nF	82nF	390nF	1µF	120nF	470nF	1.2µF	0.394	(10)	2
		39nF	100nF	330nF	47nF	150nF	390nF	68nF	220nF	560nF	120nF	560nF	1.5µF	180nF	680nF	1.8µF	0.591	(15)	3
		56nF	150nF	470nF	68nF	220nF	560nF	100nF	270nF	820nF	180nF	820nF	1.8µF	270nF	1µF	2.7µF	0.788	(20)	4
		-	-	-	82nF	270nF	680nF	120nF	390nF	1µF	220nF	1µF	2.7µF	330nF	1.2µF	3.3µF	0.985	(25)	5
	3kV	15nF	27nF	100nF	22nF	47nF	120nF	27nF	68nF	180nF	56nF	180nF	390nF	82nF	220nF	560nF	0.394	(10)	2
		22nF	39nF	150nF	33nF	68nF	180nF	39nF	100nF	270nF	82nF	270nF	680nF	120nF	330nF	820nF	0.591	(15)	3
		27nF	56nF	220nF	47nF	100nF	270nF	56nF	150nF	390nF	120nF	390nF	820nF	180nF	470nF	1.2µF	0.788	(20)	4
		-	-	-	56nF	120nF	330nF	68nF	180nF	470nF	150nF	470nF	1.2µF	220nF	560nF	1.5µF	0.985	(25)	5
	4kV	8.2nF	15nF	56nF	10nF	33nF	82nF	18nF	39nF	120nF	33nF	82nF	220nF	47nF	120nF	330nF	0.394	(10)	2
		12nF	22nF	82nF	15nF	47nF	120nF	27nF	56nF	180nF	47nF	120nF	330nF	68nF	180nF	470nF	0.591	(15)	3
		18nF	27nF	120nF	22nF	68nF	180nF	39nF	82nF	270nF	68nF	180nF	470nF	100nF	270nF	680nF	0.788	(20)	4
		-	-	-	27nF	82nF	220nF	47nF	100nF	330nF	82nF	220nF	560nF	120nF	330nF	820nF	0.985	(25)	5
	5kV	5.6nF	8.2nF	39nF	6.8nF	18nF	47nF	12nF	22nF	68nF	22nF	56nF	150nF	33nF	68nF	180nF	0.394	(10)	2
		8.2nF	12nF	56nF	10nF	27nF	68nF	18nF	33nF	100nF	33nF	82nF	180nF	47nF	100nF	270nF	0.591	(15)	3
		12nF	18nF	82nF	15nF	39nF	100nF	27nF	47nF	150nF	47nF	120nF	270nF	68nF	150nF	390nF	0.788	(20)	4
		-	-	-	18nF	47nF	120nF	33nF	56nF	180nF	56nF	150nF	330nF	82nF	180nF	470nF	0.985	(25)	5
	7.5kV	1nF	-	12nF	1.5nF	-	15nF	2.2nF	-	22nF	5.6nF	-	56nF	8.2nF	-	82nF	0.394	(10)	2
		1.5nF	-	18nF	2.2nF	-	22nF	3.3nF	-	33nF	8.2nF	-	82nF	12nF	-	120nF	0.591	(15)	3
		2.2nF	-	27nF	2.7nF	-	27nF	4.7nF	-	47nF	12nF	-	120nF	18nF	-	180nF	0.788	(20)	4
		-	-	-	3.9nF	-	39nF	5.6nF	-	56nF	15nF	-	150nF	22nF	-	220nF	0.985	(25)	5
	10kV	680pF	-	5.6nF	1nF	-	6.8nF	1.5nF	-	12nF	3.9nF	-	27nF	5.6nF	-	39nF	0.394	(10)	2
		1nF	-	8.2nF	1.5nF	-	10nF	2.2nF	-	18nF	5.6nF	-	39nF	8.2nF	-	56nF	0.591	(15)	3
		1.5nF	-	12nF	2.2nF	-	15nF	2.7nF	-	27nF	8.2nF	-	56nF	12nF	-	82nF	0.788	(20)	4
		-	-	-	2.7nF	-	18nF	3.9nF	-	33nF	10nF	-	68nF	15nF	-	100nF	0.985	(25)	5

The high voltage parts may require varnish or encapsulation to prevent surface arcing.

Available capacitance values:

NPO, C4xx dielectrics: E6, E12, E24 (see page 14). Specific values upon request.

X7R dielectric: E6, E12 in standard (see page 14). Specific values upon request.

The above table defines the standard products, other components may be built upon request.



# Voltage Multipliers

# VM Series



## FEATURES

- Miniaturized half wave voltage multipliers
- Ultra small size
- Highly efficient
- ITAR free
- Uniform stress on diodes

## PHYSICAL CHARACTERISTICS

- **Plating:** Electroless nickel/immersion gold (ENIG).

### MARKING

Series, capacitance value.

## ELECTRICAL SPECIFICATIONS

Part Number	152 VM3 G2	302 VM4 G2	302 VM6 G2	602 VM6 G2	702 VM7 G2
<b>Max. AC input voltage</b>	500 V <sub>PP</sub>	750 V <sub>PP</sub>	500 V <sub>PP</sub>	1,000 V <sub>PP</sub>	1,000 V <sub>PP</sub>
<b>Max. DC output voltage</b>	-1,500 V <sub>DC</sub>	3,000 V <sub>DC</sub> *	3,000 V <sub>DC</sub>	6,000 V <sub>DC</sub>	7,000 V <sub>DC</sub>
<b>Typical output current range</b>	0 to 100 μA	0 to 50 μA	0 to 50 μA	0 to 50 μA	0 to 25 μA
<b>Typical frequency</b>	10 to 100 kHz	10 to 100 kHz	10 to 100 kHz	10 to 100 kHz	10 to 100 kHz
<b>Number of stages</b>	3	4	6	6	7
<b>Operating and storage temperature</b>	-55°C to +125°C	-55°C to +125°C	-55°C to +125°C	-55°C to +125°C	-55°C to +125°C
<b>Pin finish</b>	ENIG Gold	ENIG Gold	ENIG Gold	ENIG Gold	ENIG Gold
<b>Peak wave solder temperature</b>	260°C 2mn	260°C 2mn	260°C 2mn	260°C 2mn	260°C 2mn
<b>Peak reflow temp.</b>	260°C	260°C	260°C	260°C	260°C
<b>Floor life</b>	MSL/JDEC 2	MSL/JDEC 2	MSL/JDEC 2	MSL/JDEC 2	MSL/JDEC 2

\* 6,000 V<sub>DC</sub> available by using two VM4 in series.

The component must be coated on the board to prevent electrical arcs.

## DIMENSIONS in inches (mm)

### VM3 - VM4

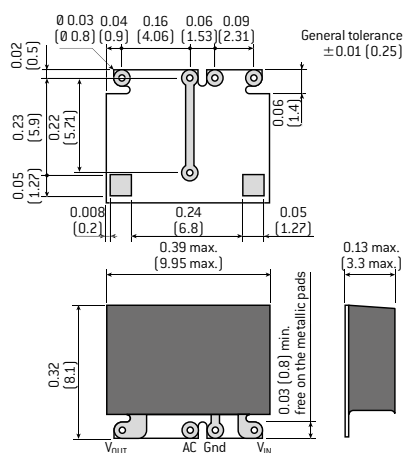

### VM6

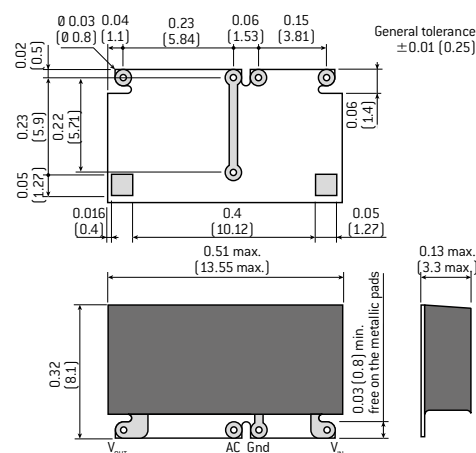

### VM7

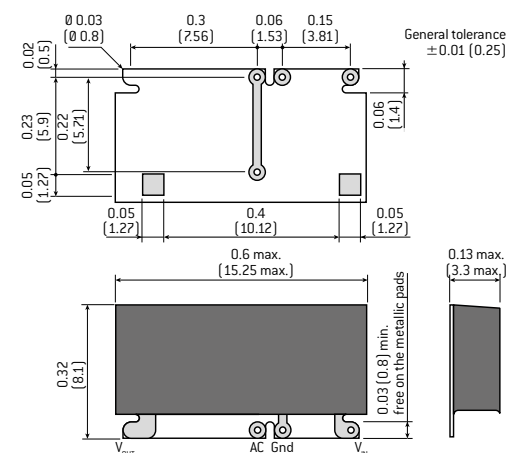

## ELECTRICAL EQUIVALENT CIRCUITS

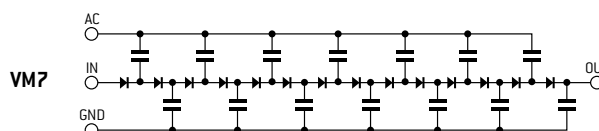
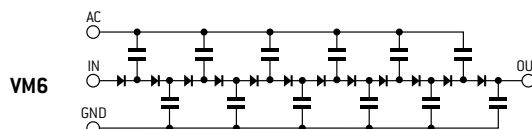
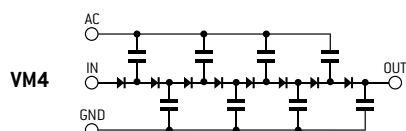
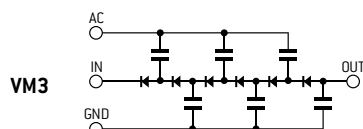

## TYPICAL MULTIPLIER CIRCUIT

VM3 - VM4

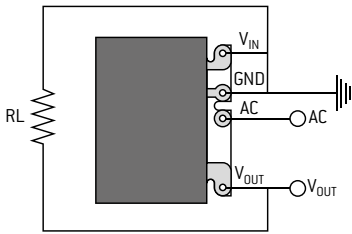

VM6

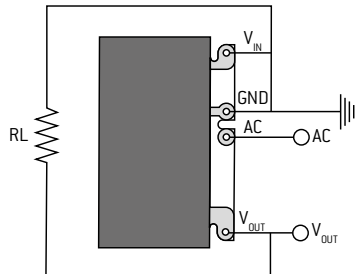

VM7

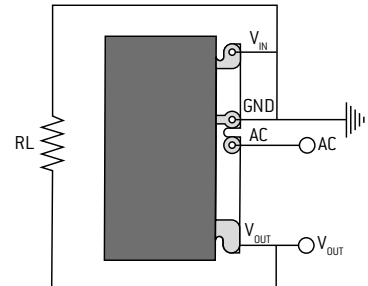

2 multipliers can be mounted in series for a DC output up to: -3000V (VM3), 6000V (VM4)

2 multipliers can be mounted in series for a DC output up to 6000V

## OUTPUT VOLTAGE vs INPUT VOLTAGE

VM3

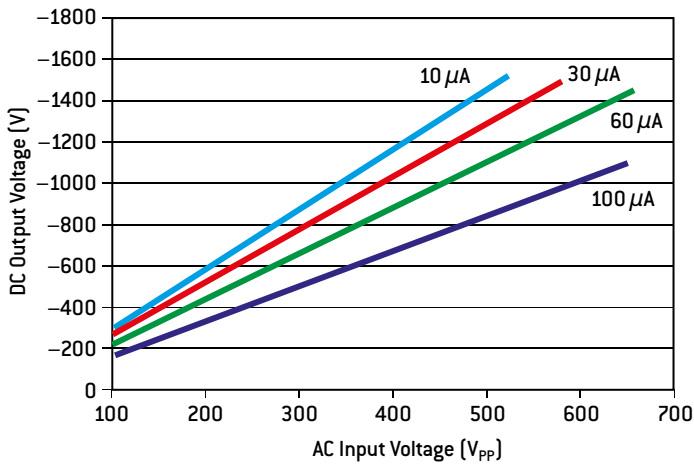

VM4

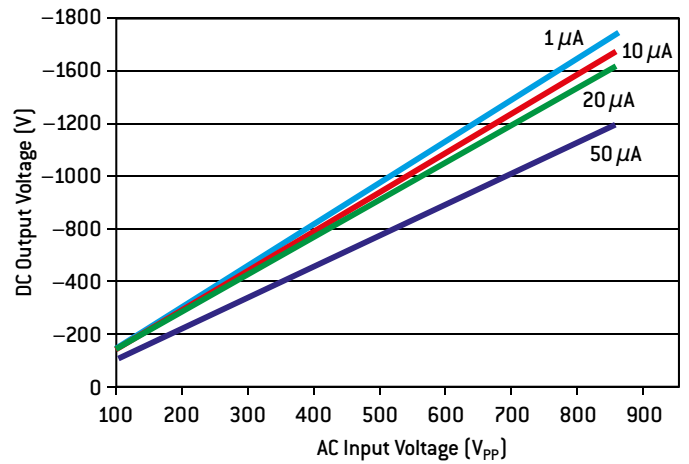

VM6

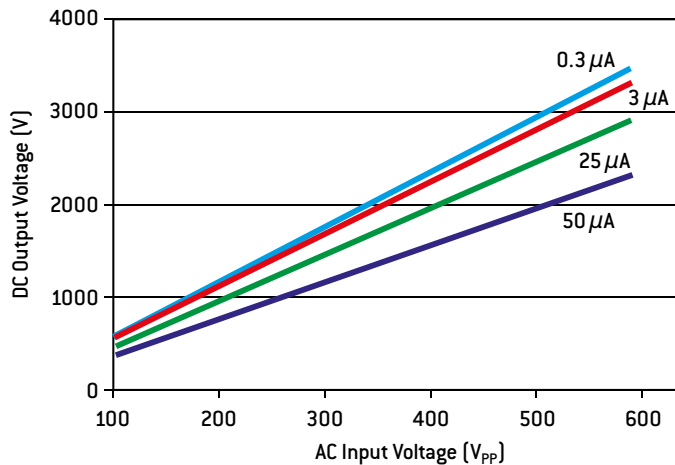

VM7

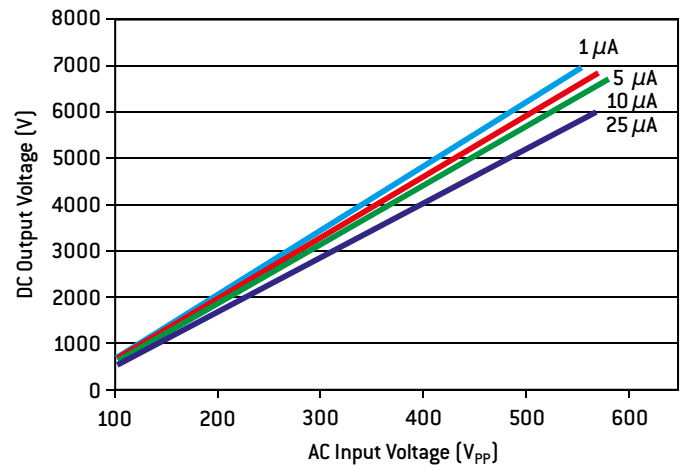

# HIGH CAPACITANCE

**GENERAL INFORMATION** ..... 68

**R SERIES (CHIPS)**

High Capacitance Chips Capacitors ..... 73

**R SERIES (LEADED)**

Radial leaded Conformal Coated Capacitors ..... 77

**TEF SERIES**

Radial leaded Conformal Coated Capacitors ..... 80

**SC / SV SERIES**

High Capacitance Stacked Capacitors..... 81

**CNC3X SERIES**

High Capacitance Stacked Capacitors..... 88

**CEC5X SERIES**

High Capacitance Stacked Capacitors..... 90

**TEP / TEV SERIES**

High Capacitance Stacked Capacitors..... 93

**TCN8X SERIES**

High Capacitance Molded Stacked Capacitors ..... 95



# General Information

These capacitors have been developed in response to demand from switched mode power supply (S.M.P.S.) and DC-DC converters manufacturers. They are particularly suitable for filtering, smoothing and decoupling purpose in Hi-Rel equipments. The capacitors utilize advanced ceramic technology to achieve Hi-Rel long operating life and small size. They are designed for hybrid assemblies and low profile printed circuit applications.

Customized assemblies may be achieved with standard bare chip sizes mentioned in the following chapters.

## TYPICAL CURVES: R Series, SC/SV Series

**X DIELECTRIC: TYPICAL VOLTAGE COEFFICIENT AT 25°C (FOR ALL SIZES)**

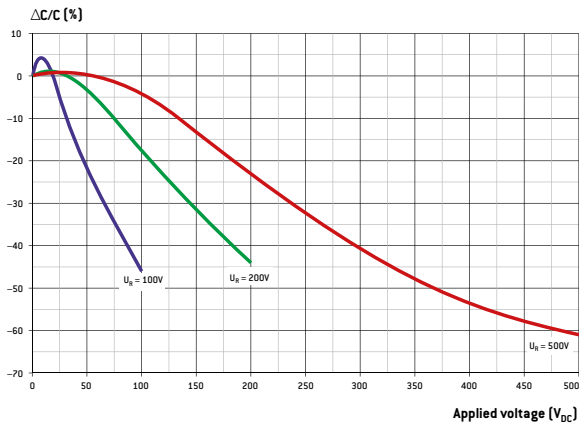

**T DIELECTRIC: TYPICAL VOLTAGE COEFFICIENT AT 25°C (for all sizes)**

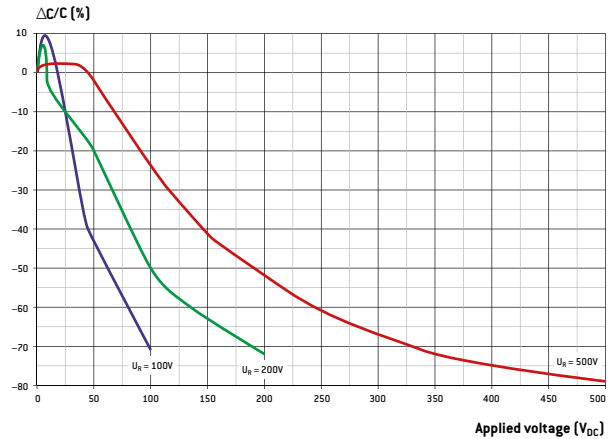

**X DIELECTRIC: TYPICAL TEMPERATURE COEFFICIENT WITHOUT VOLTAGE (for all sizes)**

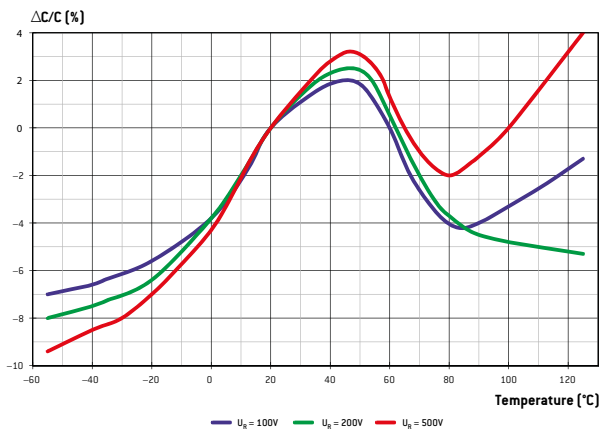

**T DIELECTRIC: TYPICAL TEMPERATURE COEFFICIENT WITHOUT VOLTAGE (for all sizes)**

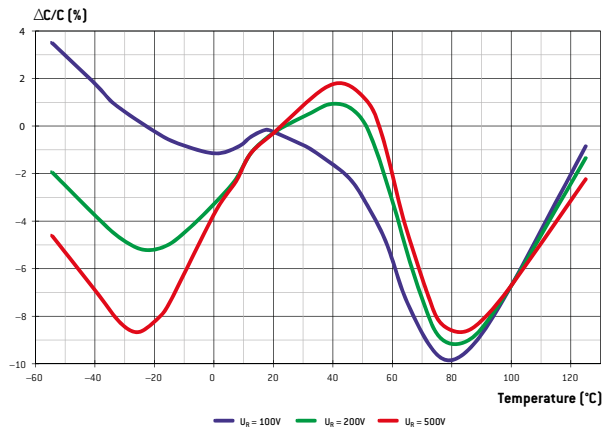

# General Information

## TYPICAL CURVES: R Series, SC/SV Series

### TYPICAL ESR VS FREQUENCY

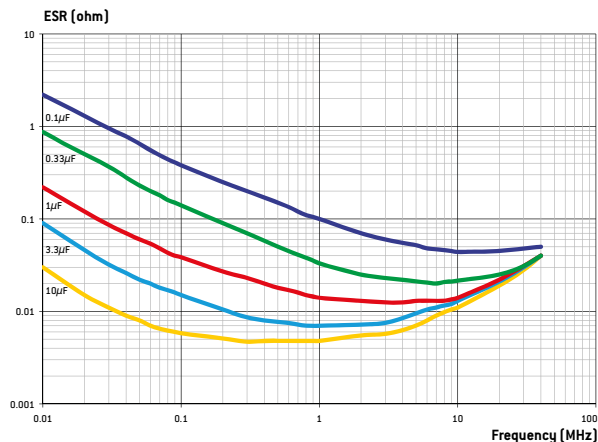

The ESR (Equivalent Serial Resistance) curves are given here for SMD (chips all case sizes) capacitors. Regarding the curves for the leaded capacitors, they are rather the same. Indeed, due to the resistivity of the raw material used and the wire diameters, the resistance of the wires is much lower than the ESR of the chips. So, in a first approach, their influence can be considered as negligible.

### TYPICAL ESR VS FREQUENCY

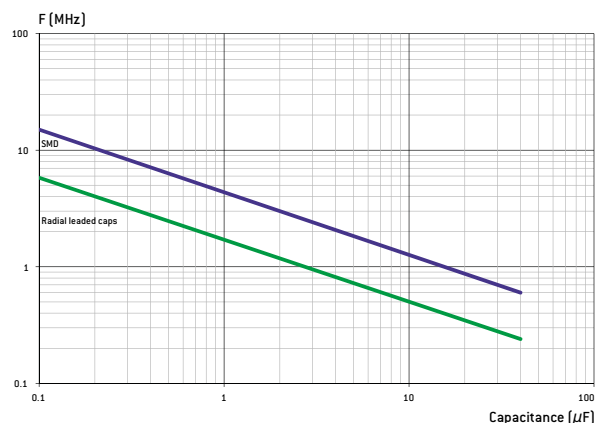

### TYPICAL MAXIMUM ADMISSIBLE CURRENT VS FREQUENCY

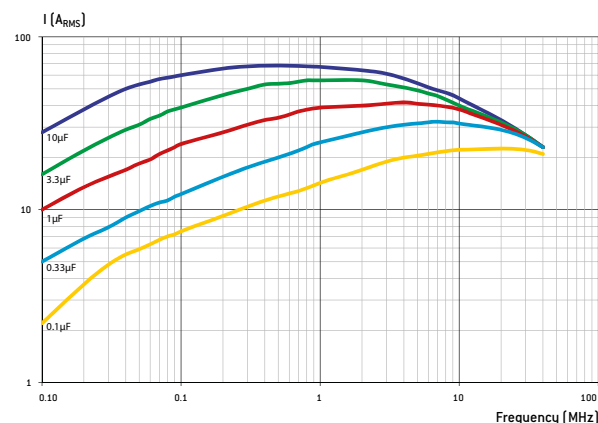

These typical curves are an example of admissible currents for one family of chip capacitors: 501R3740X chip series. For other curves and products or for further information, please contact us. Note: for the calculations, we have considered that the terminations are directly connected to an infinite heat sink. In other words, the thermal resistance of the circuit itself which depends of its type and design has not been taken into account. Moreover, the ambient temperature taken is 25°C.

HIGH CAPACITANCE

# General Information

## TYPICAL CURVES: CNC3X Series

### TYPICAL TEMPERATURE COEFFICIENT

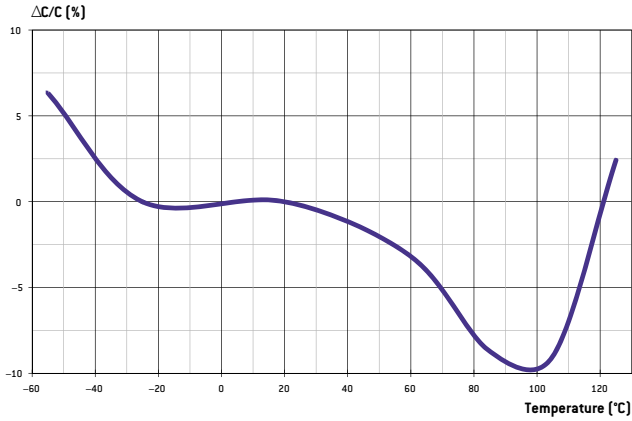

### TYPICAL VOLTAGE COEFFICIENT

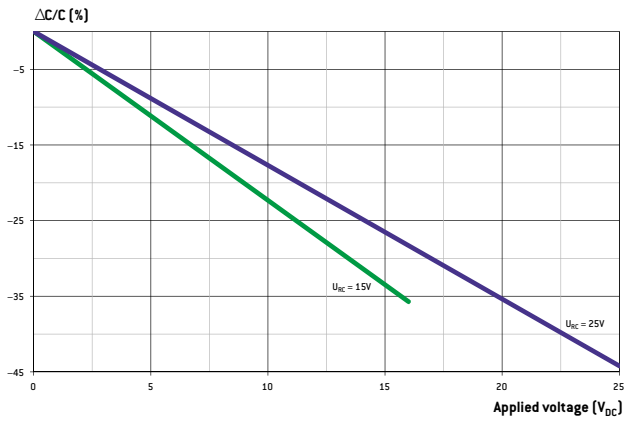

### MAXIMUM CURRENT VS FREQUENCY

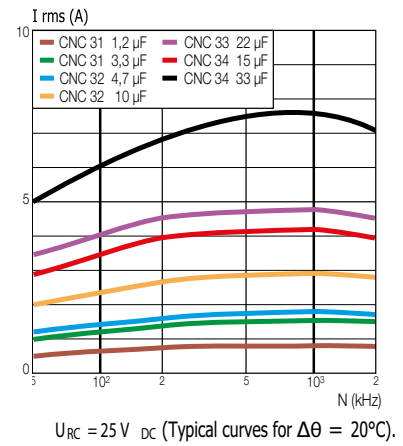
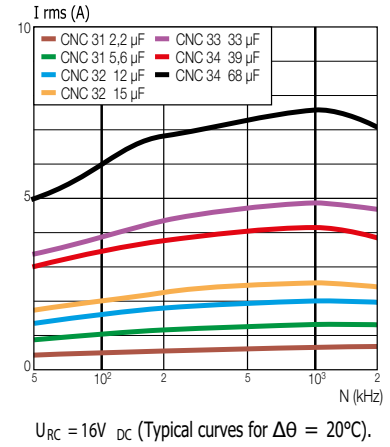

# General Information

## TYPICAL CURVES: CEC5X Series

### NPO: CURRENT VS FREQUENCY

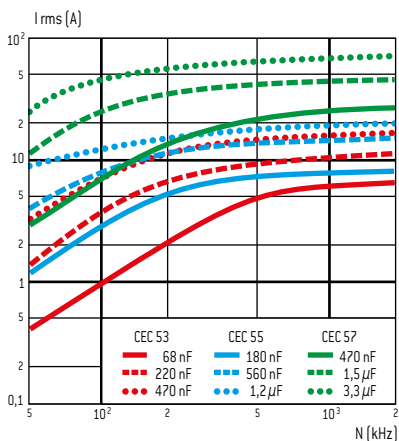

$U_{RC} = 63 V_{DC}$  (Typical curve for  $\Delta\theta = 20^\circ C$ ).

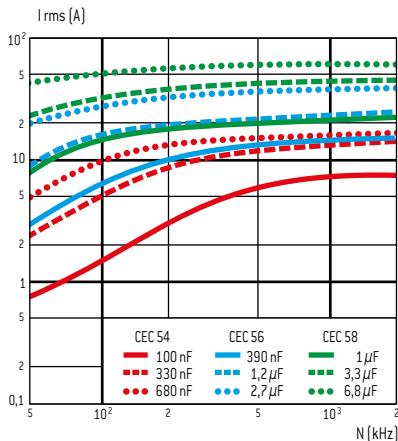

$U_{RC} = 63 V_{DC}$  (Typical curve for  $\Delta\theta = 20^\circ C$ ).

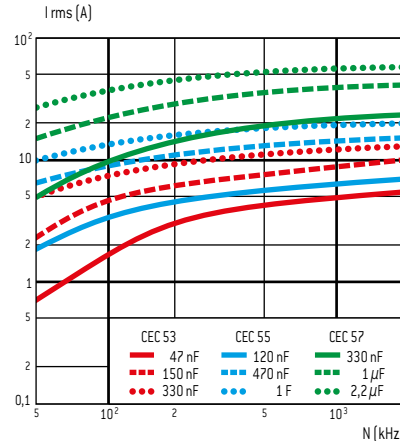

$U_{RC} = 100 V_{DC}$  (Typical curve for  $\Delta\theta = 20^\circ C$ ).

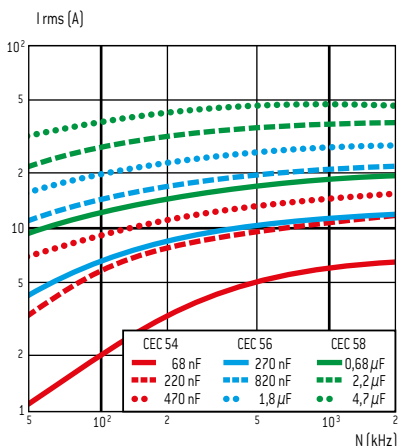

$U_{RC} = 100 V_{DC}$  (Typical curve for  $\Delta\theta = 20^\circ C$ ).

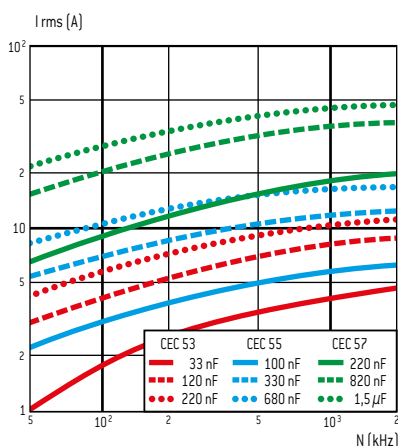

$U_{RC} = 200 V_{DC}$  (Typical curve for  $\Delta\theta = 20^\circ C$ ).

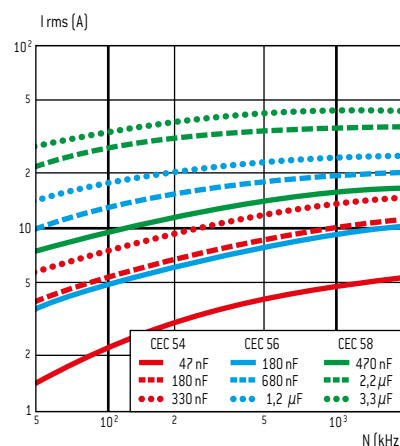

$U_{RC} = 200 V_{DC}$  (Typical curve for  $\Delta\theta = 20^\circ C$ ).

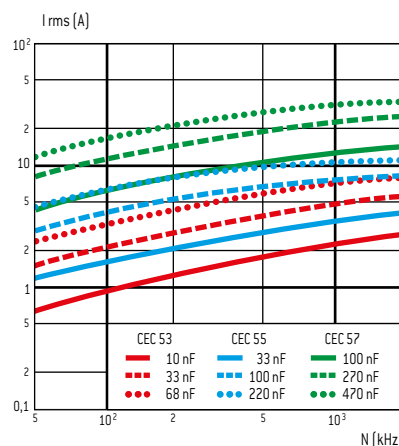

$U_{RC} = 500 V_{DC}$  (Typical curve for  $\Delta\theta = 20^\circ C$ ).

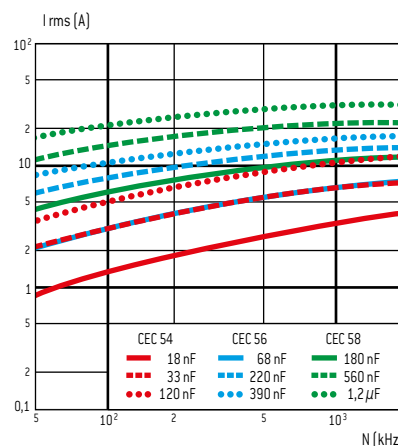

$U_{RC} = 500 V_{DC}$  (Typical curve for  $\Delta\theta = 20^\circ C$ ).

HIGH CAPACITANCE

# General Information

## TYPICAL CURVES: TCN8X Series

**TCN83: TYPICAL EQUIVALENT SERIAL RESISTANCE (ESR) VS FREQUENCY (N)**

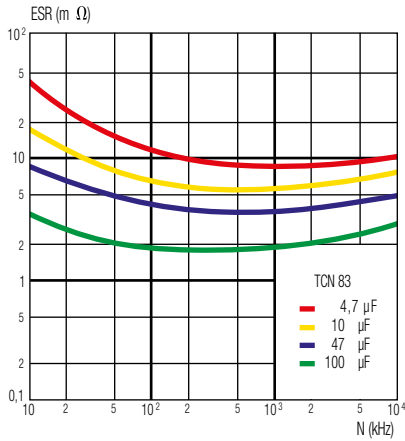

**TCN86: TYPICAL EQUIVALENT SERIAL RESISTANCE (ESR) VS FREQUENCY (N)**

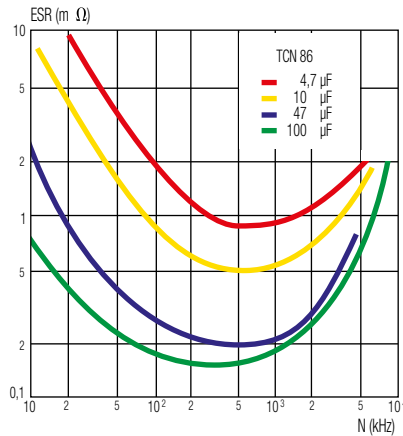

**TCN87: TYPICAL EQUIVALENT SERIAL RESISTANCE (ESR) VS FREQUENCY (N)**

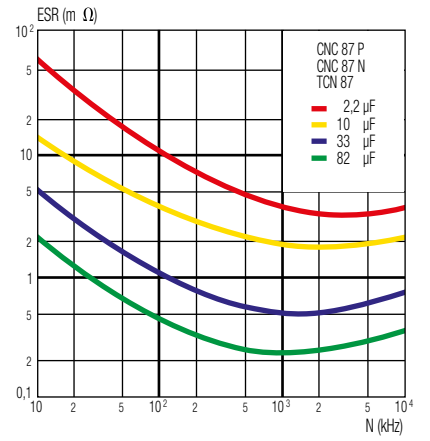

**TCN83: CURRENT (I<sub>RMS</sub>) VS FREQUENCY (N) TYPICAL CURVES FOR Δθ ≤ 20°C**

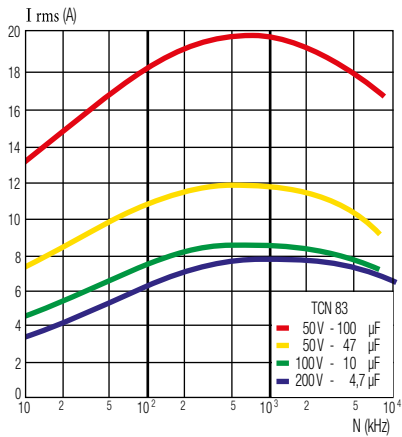

**TCN86: CURRENT (I<sub>RMS</sub>) VS FREQUENCY (N) TYPICAL CURVES FOR Δθ ≤ 20°C**

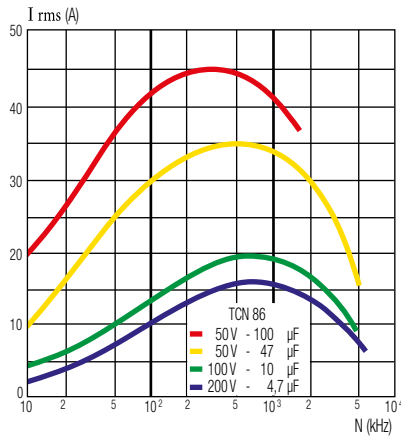

**TCN87: CURRENT (I<sub>RMS</sub>) VS FREQUENCY (N) TYPICAL CURVES FOR Δθ ≤ 20°C**

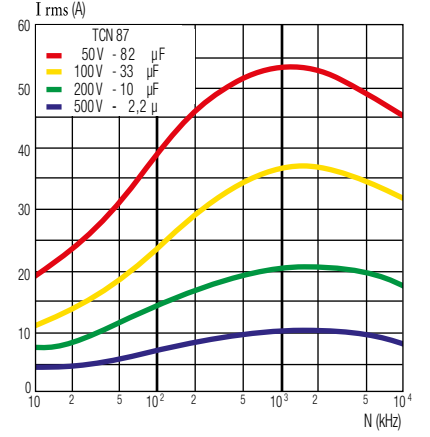



# High Capacitance Chips Capacitors

# R Series (Chips)



## FEATURES

- Multilayer chip ceramic capacitors
- Dielectric type II
- Capacitance range: 47 nF to 27 μF
- Voltage range: 50 V<sub>DC</sub> to 500 V<sub>DC</sub>

## PACKAGING

### «BLISTER» BOXES:

For all products, special «blister» boxes are used to optimize the protection of the parts during the carriage and the storage. Depending upon the termination (with or without connection) and the size, the number of the parts in each box is defined. Please, consult us for more details.

## DIMENSIONS in inches (mm)

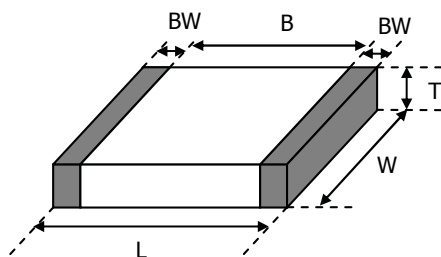

## ELECTRICAL SPECIFICATIONS

Description	«X» Series (type II)	«T» Series (type II)
CECC	2R1	2R1
EIA	X7R	X7R
Exxelia Temex Code	X	T
Operating temperature range	-55°C to +125°C	-55°C to +125°C
Storage temperature range	-55°C to +125°C	-55°C to +125°C
Maximum ΔC/°C over Temperature range without voltage applied	± 15%	± 15%
Ageing	≤2.5% per decade hour	≤2.5% per decade hour
Dissipation Factor (DF)	≤ 2.5%	≤ 2.5%
Voltage proof	U <sub>R</sub> ≤ 200 V: 2.5 × U <sub>R</sub> U <sub>R</sub> > 200 V: 2.0 × U <sub>R</sub>	U <sub>R</sub> ≤ 200 V: 2.5 × U <sub>R</sub> U <sub>R</sub> > 200 V: 2.0 × U <sub>R</sub>
Insulation Resistance (IR) at 25°C under U <sub>R</sub>	100GΩ or 1000Ω.F whichever is the less	100GΩ or 1000Ω.F whichever is the less
Insulation Resistance (IR) at 125°C under U <sub>R</sub>	10GΩ or 100Ω.F whichever is the less	10GΩ or 100Ω.F whichever is the less
Measurement Conditions for C and DF at 20°C	≤ 100pF: 1MHz / 1Vrms (no bias) > 100pF: 1KHz / 1Vrms (no bias)	≤ 100pF: 1MHz / 1Vrms (no bias) > 100pF: 1KHz / 1Vrms (no bias)
Capacitance versus applied Voltage and Temperature	See page 68	See page 68

HIGH CAPACITANCE

## HOW TO ORDER

501	R	6560	X	105	K	P	-	-RoHS
Rated voltage	Series	Exxelia size code	Dielectric code	Capacitance	Tolerance	Termination	Coating	RoHS compliant
500: 50 V 101: 100 V 201: 200 V 501: 500 V	R: High Capacitance Chips	2225 3033 3740 5440 5550 6560 6080 8060 45107	X = X7R T = X7R	1 <sup>st</sup> two digits represent significant figures; last digit specifies the number of zeros to follow.  Examples: 104: 0.1μF 335: 3.3μF 276: 27μF	K = ± 10% M = ± 20%	P (RoHS) Ag, non magnetic. Lead status: 0% Pb.  T (not RoHS) P termination with Sn/Pb/Ag solder dipping, non magnetic. Lead status: 36% Pb.	Not applicable	- = Not RoHS compliant For P termination, only the RoHS version exists. The RoHS suffix can be added for information.

# R Series (Chips)

## High Capacitance Chips Capacitors

### STANDARD RATINGS

Exxelia size code	2225				3033				3740				Capacitance value coded (C <sub>R</sub> )								
	2225				3033				3740												
Dimensions inches (mm)	L	0.224 ± 0.016 (5.7 ± 0.4)				0.291 ± 0.02 (7.4 ± 0.5)				0.378 ± 0.02 (9.6 ± 0.5)											
	W	0.252 ± 0.016 (6.4 ± 0.4)				0.315 ± 0.02 (8 ± 0.5)				0.386 ± 0.02 (9.8 ± 0.5)											
	BW min.	0.112 (0.3)				0.019 (0.5)				0.019 (0.5)											
	BW max.	0.056 (1.4)				0.079 (2)				0.079 (2)											
Ur	50 V		100 V		200 V		500 V		50 V		100 V		200 V		500 V						
Dielectric	X	T	X	T	X	T	X	T	X	T	X	T	X	T	X	T					
47 nF							0.119 (3)										473				
56							0.119 (3)										563				
68							0.119 (3)										683				
82							0.119 (3)										823				
100					0.071 (1.8)		0.119 (3)	0.091 (2.3)				0.099 (2.5)	0.103 (2.6)			0.119 (3)	104				
120					0.071 (1.8)		0.119 (3)	0.091 (2.3)				0.099 (2.5)	0.103 (2.6)			0.119 (3)	124				
150						0.079 (2)		0.130 (3.3)	0.091 (2.3)				0.099 (2.5)	0.103 (2.6)			0.119 (3)	154			
180	0.071 (1.8)		0.071 (1.8)		0.079 (2)		0.150 (3.8)	0.103 (2.6)				0.126 (3.2)	0.103 (2.6)			0.079 (2.1)	0.119 (3)	0.103 (2.6)	184		
220	0.071 (1.8)		0.071 (1.8)		0.099 (2.5)		0.177 (4.5)	0.111 (2.8)				0.126 (3.2)	0.103 (2.6)			0.079 (2.1)	0.119 (3)	0.103 (2.6)	224		
270	0.071 (1.8)		0.071 (1.8)		0.099 (2.5)	0.091 (2.3)		0.123 (3.1)				0.079 (2.1)	0.138 (3.5)	0.103 (2.6)			0.079 (2.1)	0.119 (3)	0.103 (2.6)	274	
330	0.071 (1.8)		0.071 (1.8)		0.119 (3)	0.091 (2.3)		0.079 (2.1)	0.079 (2.1)	0.079 (2.1)	0.079 (2.1)	0.165 (4.2)	0.111 (2.8)	0.079 (2.1)	0.079 (2.1)	0.079 (2.1)	0.079 (2.1)	0.130 (3.3)	0.103 (2.6)	334	
390	0.071 (1.8)		0.071 (1.8)		0.119 (3)	0.091 (2.3)		0.079 (2.1)	0.079 (2.1)	0.079 (2.1)		0.123 (3.1)	0.079 (2.1)	0.079 (2.1)	0.079 (2.1)	0.079 (2.1)	0.079 (2.1)	0.138 (3.5)	0.103 (2.6)	394	
470	0.071 (1.8)		0.071 (1.8)		0.130 (3.3)	0.091 (2.3)		0.079 (2.1)	0.079 (2.1)	0.079 (2.1)	0.091 (2.3)	0.138 (3.5)	0.079 (2.1)	0.079 (2.1)	0.079 (2.1)	0.079 (2.1)	0.079 (2.1)	0.158 (4)	0.103 (2.6)	474	
560	0.079 (2)		0.079 (2)		0.154 (3.9)	0.099 (2.5)		0.079 (2.1)	0.079 (2.1)	0.099 (2.5)	0.091 (2.3)		0.079 (2.1)	0.079 (2.1)	0.079 (2.1)	0.079 (2.1)	0.079 (2.1)	0.169 (4.3)	0.115 (2.9)	564	
680	0.079 (2)	0.091 (2.3)	0.079 (2)	0.091 (2.3)		0.122 (3.1)		0.079 (2.1)	0.079 (2.1)		0.119 (3)	0.091 (2.3)		0.079 (2.1)	0.079 (2.1)	0.099 (2.5)			0.134 (3.4)	684	
820	0.079 (2)	0.091 (2.3)	0.079 (2)	0.091 (2.3)		0.126 (3.2)		0.079 (2.1)	0.079 (2.1)		0.138 (3.5)	0.095 (2.4)		0.079 (2.1)	0.079 (2.1)	0.099 (2.5)	0.091 (2.3)		0.150 (3.8)	824	
1 µF	0.087 (2.2)	0.091 (2.3)	0.087 (2.2)	0.091 (2.3)				0.099 (2.5)	0.099 (2.5)		0.103 (2.6)			0.079 (2.1)	0.079 (2.1)		0.119 (3)	0.091 (2.3)		105	
1.2	0.099 (2.5)	0.091 (2.3)	0.099 (2.5)	0.091 (2.3)				0.099 (2.5)	0.099 (2.5)		0.115 (2.9)			0.079 (2.1)	0.079 (2.1)		0.138 (3.5)	0.091 (2.3)		125	
1.5	0.119 (3)	0.091 (2.3)	0.119 (3)	0.091 (2.3)				0.111 (2.8)	0.091 (2.3)	0.111 (2.8)	0.091 (2.3)		0.134 (3.4)	0.079 (2.1)	0.091 (2.3)	0.079 (2.1)	0.091 (2.3)	0.158 (4)	0.103 (2.6)	155	
1.8	0.126 (3.2)	0.091 (2.3)	0.126 (3.2)	0.091 (2.3)				0.111 (2.8)	0.091 (2.3)	0.111 (2.8)	0.091 (2.3)			0.099 (2.5)	0.091 (2.3)	0.099 (2.5)	0.091 (2.3)	0.181 (4.6)	0.111 (2.8)	185	
2.2	0.315 (3.8)	0.103 (2.6)	0.315 (3.8)	0.103 (2.6)				0.111 (2.8)	0.091 (2.3)	0.111 (2.8)	0.091 (2.3)			0.099 (2.5)	0.091 (2.3)	0.099 (2.5)	0.091 (2.3)		0.126 (3.2)	225	
2.7		0.115 (2.9)		0.115 (2.9)				0.130 (3.3)	0.095 (2.4)	0.130 (3.3)	0.095 (2.4)			0.111 (2.8)	0.091 (2.3)	0.111 (2.8)	0.091 (2.3)		0.142 (3.6)	275	
3.3		0.126 (3.2)		0.126 (3.2)				0.150 (3.8)	0.099 (2.5)	0.150 (3.8)	0.099 (2.5)			0.111 (2.8)	0.091 (2.3)	0.111 (2.8)	0.091 (2.3)			335	
3.9								0.111 (2.8)		0.111 (2.8)				0.130 (3.3)	0.091 (2.3)	0.130 (3.3)	0.091 (2.3)			395	
4.7								0.123 (3.1)		0.123 (3.1)				0.138 (3.5)	0.091 (2.3)	0.138 (3.5)	0.091 (2.3)			475	
5.6														0.142 (3.6)	0.103 (2.6)	0.142 (3.6)	0.103 (2.6)			565	
6.8																0.119 (3)		0.119 (3)		685	
8.2																0.142 (3.6)		0.142 (3.6)		825	
10																0.150 (3.8)		0.150 (3.8)		106	
12																					126

The thickness Tmax in inches [in mm] is indicated in the cells.

High Capacitance Chips Capacitors

R Series (Chips)

STANDARD RATINGS

Dimensions inches (mm)	Exxelia size code	5550								6560								6080								Capacitance value coded (C <sub>R</sub> )
	L	0.539 ± 0.02 (13.7 ± 0.5)								0.665 ± 0.032 (16.9 ± 0.8)								0.591 ± 0.032 (15 ± 0.8)								
	W	0.484 ± 0.02 (12.3 ± 0.5)								0.610 ± 0.032 (15.5 ± 0.8)								0.778 ± 0.0322 (19.8 ± 0.8)								
	BW min.	0.019 (0.5)								0.019 (0.5)								0.019 (0.5)								
BW max.	0.079 (2)								0.079 (2)								0.079 (2)									
U <sub>R</sub>	50 V		100 V		200 V		500 V		50 V		100 V		200 V		500 V		50 V		100 V		200 V		500 V			
Dielectric	X	T	X	T	X	T	X	T	X	T	X	T	X	T	X	T	X	T	X	T	X	T	X	T		
270 nF							0.099	0.103							0.099	0.103								274		
330							0.099	0.103							0.099	0.103								334		
390							0.099	0.103							0.099	0.103								394		
470							0.119	0.103							0.099	0.103								474		
560							0.119	0.103					0.099		0.099	0.103								564		
680							0.119	0.103					0.099		0.099	0.103						0.119	0.103	684		
820					0.119		0.138	0.103					0.099		0.119	0.103						0.119	0.103	824		
1µF	0.099		0.099		0.119		0.166	0.111	0.099		0.099		0.099	0.103	0.119	0.103						0.119	0.103	105		
1.2	0.099		0.099		0.119	0.103	0.185	0.130	0.099		0.099		0.099	0.103	0.138	0.103						0.138	0.103	125		
1.5	0.099		0.099		0.119	0.103		0.142	0.099		0.099		0.099	0.103	0.158	0.119			0.119			0.158	0.103	155		
1.8	0.099		0.099		0.119	0.103		0.162	0.099		0.099		0.099	0.103	0.178	0.119			0.119			0.178	0.103	185		
2.2	0.099		0.099		0.119	0.103			0.099		0.099		0.099	0.103		0.130			0.119	0.103	0.178	0.103		225		
2.7	0.099		0.099		0.138	0.103			0.099	0.103	0.099	0.103	0.119	0.103		0.150			0.119	0.103		0.130		275		
3.3	0.099	0.103	0.099	0.103	0.158	0.111			0.099	0.103	0.099	0.103	0.119	0.103		0.170			0.119	0.103		0.154		335		
3.9	0.099	0.103	0.099	0.103		0.123			0.099	0.103	0.099	0.103	0.138	0.103		0.119		0.119		0.138	0.103		0.174	395		
4.7	0.119	0.103	0.119	0.103		0.138			0.099	0.103	0.099	0.103	0.158	0.103		0.119		0.119		0.158	0.103			475		
5.6	0.119	0.103	0.119	0.103		0.162			0.099	0.103	0.099	0.103		0.115		0.119		0.119		0.158	0.103			565		
6.8	0.119	0.103	0.119	0.103					0.099	0.103	0.099	0.103		0.130		0.119	0.103	0.119	0.103	0.178	0.119			685		
8.2	0.138	0.103	0.138	0.103					0.119	0.103	0.119	0.103		0.150		0.119	0.103	0.119	0.103		0.142			825		
10	0.150	0.103	0.150	0.103					0.119	0.103	0.119	0.103				0.138	0.103	0.138	0.103		0.150			106		
12	0.158	0.111	0.158	0.111					0.138	0.103	0.138	0.103				0.138	0.103	0.138	0.103					126		
15		0.126		0.126					0.158	0.103	0.158	0.103				0.138	0.103	0.138	0.103					156		
18									0.103		0.103					0.103		0.103						186		
22									0.119		0.119					0.111		0.111						226		
27									0.142		0.142					0.130		0.130						276		

HIGH CAPACITANCE

The thickness T<sub>max</sub> in inches (in mm) is indicated in the cells.

# R Series (Chips)

## High Capacitance Chips Capacitors

### STANDARD RATINGS

Dimensions inches (mm)	Exxelia size code	8060								45107								Capacitance value coded (C <sub>R</sub> )	
	L	0.78 ± 0.032 (19.8 ± 0.8)								0.425 ± 0.02 (10.8 ± 0.5)									
	W	0.587 ± 0.032 (14.9 ± 0.8)								1.083 max (27.5 max)									
	BW min.	0.019 (0.5)								0.019 (0.5)									
BW max.	0.079 (2)								0.079 (2)										
U <sub>R</sub>	50 V		100 V		200 V		500 V		50 V		100 V		200 V		500 V				
Dielectric	X	T	X	T	X	T	X	T	X	T	X	T	X	T	X	T			
270 nF																	274		
330																	334		
390																	394		
470																	474		
560																	564		
680								0.119 (3)	0.103 (2.6)						0.138 (3.5)	0.123 (3.1)	684		
820								0.119 (3)	0.103 (2.6)				0.119 (3)	0.119 (3)	0.138 (3.5)	0.123 (3.1)	824		
1 μF								0.119 (3)	0.103 (2.6)	0.119 (3)		0.119 (3)		0.119 (3)	0.119 (3)	0.150 (3.8)	0.123 (3.1)	105	
1.2								0.138 (3.5)	0.103 (2.6)	0.119 (3)		0.119 (3)		0.119 (3)	0.119 (3)	0.150 (3.8)	0.123 (3.1)	125	
1.5								0.119 (3)	0.158 (4)	0.103 (2.6)	0.119 (3)	0.119 (3)	0.119 (3)	0.119 (3)	0.119 (3)	0.158 (4)	0.123 (3.1)	155	
1.8								0.119 (3)	0.178 (4.5)	0.103 (2.6)	0.119 (3)	0.119 (3)	0.119 (3)	0.119 (3)	0.119 (3)	0.178 (4.5)	0.123 (3.1)	185	
2.2								0.119 (3)	0.103 (2.6)	0.178 (4.5)	0.103 (2.6)	0.119 (3)	0.119 (3)	0.119 (3)	0.119 (3)	0.138 (3.5)	0.119 (3)	0.123 (3.1)	225
2.7								0.119 (3)	0.103 (2.6)		0.130 (3.3)	0.119 (3)	0.119 (3)	0.119 (3)	0.119 (3)	0.150 (3.8)	0.119 (3)	0.123 (3.1)	275
3.3								0.119 (3)	0.103 (2.6)		0.154 (3.9)	0.119 (3)	0.119 (3)	0.119 (3)	0.119 (3)	0.158 (4)	0.119 (3)	0.158 (4)	335
3.9	0.119 (3)		0.119 (3)		0.138 (3.5)	0.103 (2.6)		0.174 (4.4)		0.119 (3)	0.119 (3)	0.119 (3)	0.119 (3)	0.119 (3)	0.158 (4)	0.119 (3)			395
4.7	0.119 (3)		0.119 (3)		0.158 (4)	0.103 (2.6)				0.119 (3)	0.119 (3)	0.119 (3)	0.119 (3)	0.119 (3)	0.158 (4)	0.119 (3)			475
5.6	0.119 (3)		0.119 (3)		0.158 (4)	0.103 (2.6)				0.119 (3)	0.119 (3)	0.119 (3)	0.119 (3)			0.119 (3)			565
6.8	0.119 (3)	0.103 (2.6)	0.119 (3)	0.103 (2.6)	0.178 (4.5)	0.119 (3)				0.119 (3)	0.119 (3)	0.119 (3)	0.119 (3)			0.158 (4)			685
8.2	0.119 (3)	0.103 (2.6)	0.119 (3)	0.103 (2.6)			0.142 (3.6)			0.119 (3)	0.119 (3)	0.119 (3)	0.119 (3)						825
10	0.138 (3.5)	0.103 (2.6)	0.138 (3.5)	0.103 (2.6)			0.150 (3.8)			0.138 (3.5)	0.119 (3)	0.138 (3.5)	0.119 (3)						106
12	0.138 (3.5)	0.103 (2.6)	0.138 (3.5)	0.103 (2.6)						0.138 (3.5)	0.119 (3)	0.138 (3.5)	0.119 (3)						126
15	0.138 (3.5)	0.103 (2.6)	0.138 (3.5)	0.103 (2.6)						0.138 (3.5)	0.119 (3)	0.138 (3.5)	0.119 (3)						156
18			0.103 (2.6)	0.103 (2.6)							0.119 (3)		0.119 (3)						186
22			0.111 (2.8)	0.111 (2.8)							0.119 (3)		0.119 (3)						226
27			0.130 (3.3)	0.130 (3.3)															276

The thickness T<sub>max</sub> in inches (in mm) is indicated in the cells.

# Radial Leaded Conformal Coated Capacitors

# R Series (Leaded)



## FEATURES

- Multilayer conformal coated radial ceramic capacitors
- Dielectric type II
- Capacitance range: 47 nF to 27 μF
- Voltage range: 50 V<sub>DC</sub> to 500 V<sub>DC</sub>

## PACKAGING

### «BLISTER» BOXES:

For all products, special «blister» boxes are used to optimize the protection of the parts during the carriage and the storage. Depending upon the termination (with or without connection) and the size, the number of the parts in each box is defined. Please, consult us for more details.

## DIMENSIONS in inches (mm)

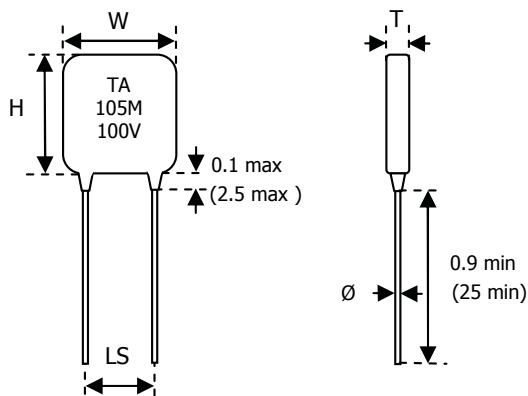

## ELECTRICAL SPECIFICATIONS

Description	«X» Series	«T» Series
CECC	2R1	2R1
EIA	X7R	X7R
Exxelia Temex Code	X	T
Operating temperature range	-55°C to +125°C	-55°C to +125°C
Storage temperature range	-55°C to +125°C	-55°C to +125°C
Maximum ΔC/°C over Temperature range without voltage applied	± 15%	± 15%
Ageing	≤2.5% per decade hour	≤2.5% per decade hour
Dissipation Factor (DF)	≤ 2.5%	≤ 2.5%
Voltage proof	U <sub>R</sub> ≤ 200 V: 2.5 x U <sub>R</sub> U <sub>R</sub> > 200 V: 2.0 x U <sub>R</sub>	U <sub>R</sub> ≤ 200 V: 2.5 x U <sub>R</sub> U <sub>R</sub> > 200 V: 2.0 x U <sub>R</sub>
Insulation Resistance (IR) at 25°C under U <sub>R</sub>	100GΩ or 1000Ω.F whichever is the less	100GΩ or 1000Ω.F whichever is the less
Insulation Resistance (IR) at 125°C under U <sub>R</sub>	10GΩ or 100Ω.F whichever is the less	10GΩ or 100Ω.F whichever is the less
Measurement Conditions for C and DF at 20°C	≤ 100pF: 1MHz / 1Vrms (no bias) > 100pF: 1KHz / 1Vrms (no bias)	≤ 100pF: 1MHz / 1Vrms (no bias) > 100pF: 1KHz / 1Vrms (no bias)
Capacitance versus applied Voltage and Temperature	See page 68	See page 68

## MARKING

Size	Marking codes	Example
≤ 2225	Cap code + Tolerance code Rated voltage value	103M 100 V
> 2225	«TA» logo Cap code + Tolerance code Rated voltage value	TA 103M 100 V

Note: the marking is only available for leaded capacitors.

## HOW TO ORDER

501	R	6560	X	105	K	R	-	-RoHS
Rated voltage	Series	Exxelia size code	Dielectric code	Capacitance	Tolerance	Termination	Coating	RoHS compliant
500: 50 V 101: 100 V 201: 200 V 501: 500 V	R: Radial leaded 2 wires, epoxy coated.	2225 3033 3740 5440 5550 6560 6080 8060 45107	X = X7R T = X7R	1 <sup>st</sup> two digits represent significant figures; last digit specifies the number of zeros to follow.  Examples: 104: 0.1μF 335: 3.3μF 276: 27μF	K = ±10% M = ±20%	R (RoHS)  R (not RoHS)	100% tinned copper, non magnetic. Lead status: 0% Pb.  Sn (70%) Pb (30%) plated Copper, non magnetic. Lead status: Pb 30% of the plated layer	Not applicable  - = Not RoHS compliant Both RoHS and non-RoHS versions exist. This is due to the wishes of some customers who still need non-RoHS components in their applications. This suffix must be required for RoHS compliancy.

# R Series (Leaded)

## Radial Leaded Conformal Coated Capacitors

### STANDARD RATINGS

Dimensions Inches (mm)	Exxelia size code	2225								3033								3740								Capacitance value coded (C <sub>R</sub> )
	W max.	0.300 (7.6)								0.434 (11.0)								0.500 (12.7)								
Inches (mm)	H max.	0.386 (9.8)								0.434 (11.0)								0.485 (12.3)								
	LS	0.2 ± 0.02 (5.08 ± 0.5)								0.2 ± 0.02 (5.08 ± 0.5)								0.402 ± 0.02 (10.2 ± 0.5)								
Inches (mm)	D ± 10%	0.020 (0.5)								0.020 (0.5)								0.024 (0.6)								
	U <sub>R</sub>	50 V		100 V		200 V		500 V		50 V		100 V		200 V		500 V		50 V		100 V		200 V		500 V		
Dielectric		X	T	X	T	X	T	X	T	X	T	X	T	X	T	X	T	X	T	X	T	X	T	X	T	
47 nF									0.170 (4.3)																473	
56									0.170 (4.3)																563	
68									0.170 (4.3)																683	
82									0.170 (4.3)																823	
100						0.123 (3.1)		0.170 (4.3)	0.142 (3.6)						0.15 (3.8)	0.154 (3.9)							0.17 (4.3)	104		
120						0.123 (3.1)		0.170 (4.3)	0.142 (3.6)						0.15 (3.8)	0.154 (3.9)							0.17 (4.3)	124		
150						0.130 (3.3)		0.181 (4.6)	0.142 (3.6)						0.15 (3.8)	0.154 (3.9)							0.17 (4.3)	154		
180	0.123 (3.1)		0.123 (3.1)		0.130 (3.3)		0.201 (5.1)	0.154 (3.9)							0.178 (4.5)	0.154 (3.9)					0.134 (3.4)		0.17 (4.3)	0.154 (3.9)	184	
220	0.123 (3.1)		0.123 (3.1)		0.150 (3.8)		0.229 (5.8)	0.162 (4.1)							0.178 (4.5)	0.154 (3.9)					0.134 (3.4)		0.17 (4.3)	0.154 (3.9)	224	
270	0.123 (3.1)		0.123 (3.1)		0.150 (3.8)	0.142 (3.6)		0.173 (4.4)					0.134 (3.4)		0.189 (4.8)	0.154 (3.9)					0.134 (3.4)		0.17 (4.3)	0.154 (3.9)	274	
330	0.123 (3.1)		0.123 (3.1)		0.170 (4.3)	0.142 (3.6)			0.134 (3.4)		0.134 (3.4)		0.134 (3.4)		0.217 (5.5)	0.162 (4.1)	0.134 (3.4)		0.134 (3.4)		0.134 (3.4)		0.182 (4.6)	0.154 (3.9)	334	
390	0.123 (3.1)		0.123 (3.1)		0.170 (4.3)	0.142 (3.6)			0.134 (3.4)		0.134 (3.4)		0.134 (3.4)		0.174 (4.4)	0.134 (3.4)		0.134 (3.4)		0.134 (3.4)		0.134 (3.4)		0.189 (4.8)	0.154 (3.9)	394
470	0.123 (3.1)		0.123 (3.1)		0.181 (4.6)	0.142 (3.6)			0.134 (3.4)		0.134 (3.4)		0.134 (3.4)	0.142 (3.6)		0.189 (4.8)	0.134 (3.4)		0.134 (3.4)		0.134 (3.4)		0.209 (5.3)	0.154 (3.9)	474	
560	0.130 (3.3)		0.130 (3.3)		0.205 (5.2)	0.150 (3.8)			0.134 (3.4)		0.134 (3.4)		0.15 (3.8)	0.142 (3.6)			0.134 (3.4)		0.134 (3.4)		0.134 (3.4)		0.221 (5.6)	0.166 (4.2)	564	
680	0.130 (3.3)	0.142 (3.6)	0.130 (3.3)	0.142 (3.6)		0.173 (4.4)			0.134 (3.4)		0.134 (3.4)		0.17 (4.3)	0.142 (3.6)			0.134 (3.4)		0.134 (3.4)		0.150 (3.8)		0.186 (4.7)		684	
820	0.130 (3.3)	0.142 (3.6)	0.130 (3.3)	0.142 (3.6)		0.177 (4.5)			0.134 (3.4)		0.134 (3.4)		0.189 (4.8)	0.146 (3.7)			0.134 (3.4)		0.134 (3.4)		0.150 (3.8)	0.142 (3.6)	0.201 (5.1)		824	
1 µF	0.138 (3.5)	0.142 (3.6)	0.138 (3.5)	0.142 (3.6)					0.150 (3.8)		0.150 (3.8)				0.154 (3.9)			0.134 (3.4)		0.134 (3.4)		0.170 (4.3)	0.142 (3.6)		105	
1.2	0.150 (3.8)	0.142 (3.6)	0.150 (3.8)	0.142 (3.6)					0.150 (3.8)		0.150 (3.8)				0.166 (4.2)			0.134 (3.4)		0.134 (3.4)		0.189 (4.8)	0.142 (3.6)		125	
1.5	0.170 (4.3)	0.142 (3.6)	0.170 (4.3)	0.142 (3.6)					0.162 (4.1)	0.142 (3.6)	0.162 (4.1)	0.142 (3.6)			0.186 (4.7)			0.134 (3.4)	0.142 (3.6)	0.134 (3.4)	0.142 (3.6)	0.209 (5.3)	0.154 (3.9)		155	
1.8	0.177 (4.5)	0.142 (3.6)	0.177 (4.5)	0.142 (3.6)					0.162 (4.1)	0.142 (3.6)	0.162 (4.1)	0.142 (3.6)						0.15 (3.8)	0.142 (3.6)	0.15 (3.8)	0.142 (3.6)	0.232 (5.9)	0.162 (4.1)		185	
2.2	0.201 (5.1)	0.154 (3.9)	0.201 (5.1)	0.154 (3.9)					0.162 (4.1)	0.142 (3.6)	0.162 (4.1)	0.142 (3.6)						0.15 (3.8)	0.142 (3.6)	0.15 (3.8)	0.142 (3.6)		0.178 (4.5)		225	
2.7		0.165 (4.2)		0.165 (4.2)					0.182 (4.6)	0.146 (3.7)	0.182 (4.6)	0.146 (3.7)						0.162 (4.1)	0.142 (3.6)	0.162 (4.1)	0.142 (3.6)		0.193 (4.9)		275	
3.3		0.177 (4.5)		0.177 (4.5)					0.201 (5.1)	0.150 (3.8)	0.201 (5.1)	0.150 (3.8)						0.162 (4.1)	0.142 (3.6)	0.162 (4.1)	0.142 (3.6)				335	
3.9									0.162 (4.1)		0.162 (4.1)							0.182 (4.6)	0.142 (3.6)	0.182 (4.6)	0.142 (3.6)				395	
4.7									0.174 (4.4)		0.174 (4.4)							0.189 (4.8)	0.142 (3.6)	0.189 (4.8)	0.142 (3.6)				475	
5.6																			0.193 (4.9)	0.154 (3.9)	0.193 (4.9)	0.154 (3.9)				565
6.8																				0.17 (4.3)		0.17 (4.3)				685
8.2																					0.193 (4.9)		0.193 (4.9)			825
10																					0.201 (5.1)		0.201 (5.1)			106

The thickness Tmax in inches (in mm) is indicated in the cells.

# Radial Leaded Conformal Coated Capacitors

# R Series (Leaded)

## STANDARD RATINGS

Dimensions Inches (mm)	Exxelia size code	5550								6560								6080/8060								Capacitance value coded (C <sub>r</sub> )
	W max.	0.678 (17.2)								0.800 (20.3)								0.741 / 0.930 (18.8) / (23.6)								
	H max.	0.583 (14.8)								0.721 (18.3)								0.890 / 0.697 (22.6) / (17.7)								
	LS	0.598 ± 0.02 (15.2 ± 0.5)								0.701 ± 0.02 (17.8 ± 0.5)								0.598 ± 0.02 (15.2 ± 0.5) / (20.3 ± 0.5)								
	D ± 10%	0.035 (0.9)								0.035 (0.9)								0.035 / 0.035 (0.9) / (0.9)								
U <sub>r</sub>		50 V		100 V		200 V		500 V		50 V		100 V		200 V		500 V		50 V		100 V		200 V		500 V		
Dielectric		X	T	X	T	X	T	X	T	X	T	X	T	X	T	X	T	X	T	X	T	X	T	X	T	
	270 nF							0.150 (3.8)	0.154 (3.9)							0.150 (3.8)	0.154 (3.9)							274		
	330							0.150 (3.8)	0.154 (3.9)							0.150 (3.8)	0.154 (3.9)							334		
	390							0.150 (3.8)	0.154 (3.9)							0.150 (3.8)	0.154 (3.9)							394		
	470							0.170 (4.3)	0.154 (3.9)							0.150 (3.8)	0.154 (3.9)							474		
	560							0.170 (4.3)	0.154 (3.9)				0.150 (3.8)			0.150 (3.8)	0.154 (3.9)							564		
	680							0.170 (4.3)	0.154 (3.9)				0.150 (3.8)			0.150 (3.8)	0.154 (3.9)					0.170 (4.3)	0.154 (3.9)	684		
	820						0.170 (4.3)	0.189 (4.8)	0.154 (3.9)				0.150 (3.8)		0.170 (4.3)	0.154 (3.9)					0.170 (4.3)	0.154 (3.9)		824		
	1 μF	0.150 (3.8)	0.150 (3.8)	0.170 (4.3)	0.237 (6)	0.162 (4.1)	0.150 (3.8)	0.150 (3.8)	0.150 (3.8)	0.154 (3.9)	0.170 (4.3)	0.154 (3.9)	0.170 (4.3)	0.154 (3.9)							0.170 (4.3)	0.154 (3.9)		105		
	1.2	0.150 (3.8)	0.150 (3.8)	0.170 (4.3)	0.154 (3.9)	0.182 (4.6)	0.150 (3.8)	0.150 (3.8)	0.150 (3.8)	0.154 (3.9)	0.189 (4.8)	0.154 (3.9)									0.189 (4.8)	0.154 (3.9)		125		
	1.5	0.150 (3.8)	0.150 (3.8)	0.170 (4.3)	0.154 (3.9)	0.193 (4.9)	0.150 (3.8)	0.150 (3.8)	0.150 (3.8)	0.154 (3.9)	0.209 (5.3)	0.17 (4.3)						0.170 (4.3)			0.209 (5.3)	0.154 (3.9)		155		
	1.8	0.150 (3.8)	0.150 (3.8)	0.170 (4.3)	0.154 (3.9)	0.213 (5.4)	0.150 (3.8)	0.150 (3.8)	0.150 (3.8)	0.154 (3.9)	0.229 (5.8)	0.17 (4.3)						0.170 (4.3)			0.229 (5.8)	0.154 (3.9)		185		
	2.2	0.150 (3.8)	0.150 (3.8)	0.170 (4.3)	0.154 (3.9)		0.150 (3.8)	0.150 (3.8)	0.150 (3.8)	0.154 (3.9)		0.182 (4.6)						0.170 (4.3)	0.154 (3.9)	0.229 (5.8)	0.154 (3.9)			225		
	2.7	0.150 (3.8)	0.150 (3.8)	0.189 (4.8)	0.154 (3.9)		0.150 (3.8)	0.154 (3.9)	0.150 (3.8)	0.154 (3.9)	0.170 (4.3)	0.154 (3.9)	0.201 (5.1)					0.170 (4.3)	0.154 (3.9)		0.182 (4.6)			275		
	3.3	0.150 (3.8)	0.154 (3.9)	0.150 (3.8)	0.154 (3.9)	0.209 (5.3)	0.162 (4.1)		0.150 (3.8)	0.154 (3.9)	0.150 (3.8)	0.154 (3.9)	0.170 (4.3)	0.154 (3.9)	0.221 (5.6)			0.170 (4.3)	0.154 (3.9)		0.205 (5.2)			335		
	3.9	0.150 (3.8)	0.154 (3.9)	0.150 (3.8)	0.154 (3.9)	0.174 (4.4)		0.150 (3.8)	0.154 (3.9)	0.150 (3.8)	0.154 (3.9)	0.189 (4.8)	0.154 (3.9)				0.170 (4.3)	0.170 (4.3)	0.189 (4.8)	0.154 (3.9)	0.225 (5.7)			395		
	4.7	0.170 (4.3)	0.154 (3.9)	0.170 (4.3)	0.154 (3.9)	0.189 (4.8)		0.150 (3.8)	0.154 (3.9)	0.150 (3.8)	0.154 (3.9)	0.209 (5.3)	0.154 (3.9)				0.170 (4.3)	0.170 (4.3)	0.209 (5.3)	0.154 (3.9)				475		
	5.6	0.170 (4.3)	0.154 (3.9)	0.170 (4.3)	0.154 (3.9)	0.213 (5.4)		0.150 (3.8)	0.154 (3.9)	0.150 (3.8)	0.154 (3.9)		0.166 (4.2)				0.170 (4.3)	0.170 (4.3)	0.209 (5.3)	0.154 (3.9)				565		
	6.8	0.170 (4.3)	0.154 (3.9)	0.170 (4.3)	0.154 (3.9)			0.150 (3.8)	0.154 (3.9)	0.150 (3.8)	0.154 (3.9)		0.182 (4.6)				0.170 (4.3)	0.154 (3.9)	0.170 (4.3)	0.154 (3.9)	0.228 (5.8)	0.170 (4.3)		685		
	8.2	0.189 (4.8)	0.154 (3.9)	0.189 (4.8)	0.154 (3.9)			0.170 (4.3)	0.154 (3.9)	0.170 (4.3)	0.154 (3.9)		0.201 (5.1)				0.170 (4.3)	0.154 (3.9)	0.170 (4.3)	0.154 (3.9)	0.193 (4.9)			825		
	10	0.201 (5.1)	0.154 (3.9)	0.201 (5.1)	0.154 (3.9)			0.170 (4.3)	0.154 (3.9)	0.170 (4.3)	0.154 (3.9)						0.189 (4.8)	0.154 (3.9)	0.189 (4.8)	0.154 (3.9)	0.201 (5.1)			106		
	12	0.209 (5.3)	0.162 (4.1)	0.209 (5.3)	0.162 (4.1)			0.189 (4.8)	0.154 (3.9)	0.189 (4.8)	0.154 (3.9)						0.189 (4.8)	0.154 (3.9)	0.189 (4.8)	0.154 (3.9)				126		
	15		0.178 (4.5)		0.178 (4.5)			0.209 (5.3)	0.154 (3.9)	0.209 (5.3)	0.154 (3.9)						0.189 (4.8)	0.154 (3.9)	0.189 (4.8)	0.154 (3.9)				156		
	18								0.154 (3.9)		0.154 (3.9)						0.154 (3.9)		0.154 (3.9)					186		
	22								0.17 (4.3)		0.17 (4.3)						0.162 (4.1)		0.162 (4.1)					226		
	27								0.193 (4.9)		0.193 (4.9)						0.182 (4.6)		0.182 (4.6)					276		

The thickness Tmax in inches [in mm] is indicated in the cells.

# TEF Serie

## Radial Leaded Conformal Coated Capacitors



### DIMENSIONS in inches (mm)

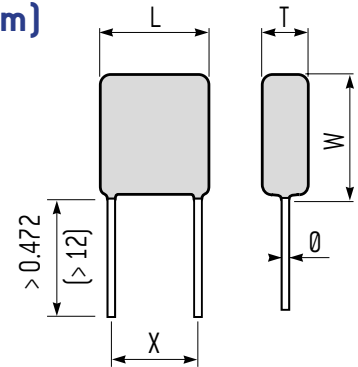

### FEATURES

- Multilayer chips ceramic capacitors
- NPO dielectric
- Capacitance range: 10nF to 680nF
- Voltage range : 50 V<sub>DC</sub> to 500 V<sub>DC</sub>

### PHYSICAL CHARACTERISTICS

#### CONSTRUCTION

Radial leaded conformal coating for through hole circuits.

#### MARKING

Series, Capacitance value, tolerance, rated voltage, date code.

### ELECTRICAL SPECIFICATIONS

DIELECTRIC	NPO
Maximum $\Delta C/C$ over temp. range without voltage	NA
Temperature coefficient	(0 ± 30)ppm/°C
Ageing	None
Operating temperature	-55°C to +125°C
Rated voltage (U <sub>RC</sub> )	63 V <sub>DC</sub> to 500 V <sub>DC</sub>
Dielectric withstanding voltage	2.5 U <sub>RC</sub> for U <sub>RC</sub> < 500 V <sub>DC</sub> 2 U <sub>RC</sub> for U <sub>RC</sub> = 500 V <sub>DC</sub>
Capacitance	at 1kHz
Dissipation factor	≤ 0.15% at 1kHz
Insulation resistance at 25°C under U <sub>RC</sub>	≥ 1,000 MΩ.μF

### STANDARD RATINGS

Size	3033	3740	5550	6080	8060	
Size code	53	54	55	56	65	
Dimensions inches (mm)	L max.	0.400 (10.16)	0.500 (12.7)	0.689 (17.5)	0.760 (19.3)	0.985 (25)
	W max.	0.461 (11.7)	0.560 (14.2)	0.650 (16.5)	0.945 (24)	0.749 (19)
	T min.	0.197 (5)	0.197 (5)	0.197 (5)	0.197 (5)	0.197 (5)
	X	0.2 ± 0.02 (5.08 ± 0.5)	0.4 ± 0.02 (10.16 ± 0.5)	0.551 ± 0.02 (14.7 ± 0.5)	0.6 ± 0.02 (15.24 ± 0.5)	0.835 ± 0.02 (21.2 ± 0.5)
	Ø ± 10%	0.024 (0.6)	0.024 (0.6)	0.031 (0.8)	0.031 (0.8)	0.031 (0.8)
Rated voltage (U <sub>RC</sub> )	Min. Capacitance value	10nF	18nF	33nF	68nF	68nF
	63 V	100nF	180nF	330nF	680nF	680nF
	100 V	82nF	120nF	220nF	470nF	470nF
	200 V	56nF	82nF	180nF	330nF	330nF
	500 V	18nF	27nF	56nF	100nF	100nF

Available capacitance values: NPO dielectric: E6, E12, E24 (see page 14). Specific values upon request. The above table defines the standard products, other components may be built upon request.

### HOW TO ORDER

T	EF	56	W	F	68nF	±10%	200 V	-
Series	Dielectric code	Exxelia size code	RoHS compliant	Quality level	Capacitance	Tolerance	Rated voltage	Reliability level
T = Radial leads, conformal coating	EF = NPO	53 54 55 56 65	- = No RoHS W = RoHS compliant	- = standard quality level F = Hi-Rel quality: screening in accordance with Exxelia specification	Capacitance value in clear	NPO: ±1% ±2% ±5% ±10% ±20%	63 V 100 V 200 V 500 V	For F parts only. Acc. to Exxelia spec. - T5 T6 See page 15



# High Capacitance Stacked Capacitors

# SC / SV Series

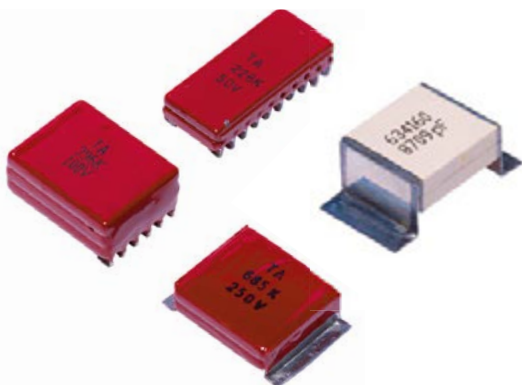

## FEATURES

- Multilayer stacked ceramic capacitors
- Dielectric type II
- Capacitance range: 47 nF to 390 μF
- Voltage range: 50 V<sub>DC</sub> to 500 V<sub>DC</sub>
- SV Series: 2 wires components
- SC Series: 4 wires (W4), Dual In Line (DIL) or ribbons terminations

## MARKING

Size	Marking codes	Example
	<<TA>> logo	TA
All sizes	Cap code + Tolerance code	105M
	Rated voltage value	100 V

## PACKAGING

<<Blister>> boxes:

For all products, special <<blister>> boxes are used to optimize the protection of the parts during the carriage and the storage. Depending upon the termination (with or without connection) and the size, the number of the parts in each box is defined. Please, consult us for more details.

## ELECTRICAL SPECIFICATIONS

Description	<<X>> Series (type II)	<<T>> Series (type II)
CECC	2R1	2R1
EIA	X7R	X7R
Exxelia Temex Code	X	T
Operating temperature range	-55°C to +125°C	-55°C to +125°C
Storage temperature range	-55°C to +125°C	-55°C to +125°C
Maximun ΔC/°C over Temperature range without voltage applied	± 15%	± 15%
Ageing	≤2.5% per decade hour	≤2.5% per decade hour
Dissipation Factor (DF)	≤ 2.5%	≤ 2.5%
Voltage proof	U <sub>R</sub> ≤ 200 V: 2.5 x U <sub>R</sub> U <sub>R</sub> > 200 V: 2.0 x U <sub>R</sub>	U <sub>R</sub> ≤ 200 V: 2.5 x U <sub>R</sub> U <sub>R</sub> > 200 V: 2.0 x U <sub>R</sub>
Insulation Resistance (IR) at 25°C under U <sub>R</sub>	100GΩ or 1000Ω.F whichever is the less	100GΩ or 1000Ω.F whichever is the less
Insulation Resistance (IR) at 125°C under U <sub>R</sub>	10GΩ or 100Ω.F whichever is the less	10GΩ or 100Ω.F whichever is the less
Measurement Conditions for C and DF at 20°C	≤ 100pF: 1MHz / 1Vrms (no bias) > 100pF: 1KHz / 1Vrms (no bias)	≤ 100pF: 1MHz / 1Vrms (no bias) > 100pF: 1KHz / 1Vrms (no bias)
Capacitance versus applied Voltage and Temperature	See page 68	See page 68

HIGH CAPACITANCE

## HOW TO ORDER

201	SV	01	X	105	K	R	-	-RoHS																		
Rated voltage	Series	Exxelia size code	Dielectric code	Capacitance	Tolerance	Termination	Coating	RoHS Compliant																		
500: 50 V 101: 100 V 201: 200 V 501: 500 V	SC SV	00 (SC only) 01 02 03 04 05 06 07 10 (SC only) 11 (SC only) 12 (SC only) 18 (SC only)	X = X7R T = X7R	1 <sup>st</sup> two digits represent significant figures; last digit specifies the number of zeros to follow.  Examples: 104: 0.1μF 335: 3.3μF 156: 15μF 107: 10μF	K = ±10% M = ±20%	<table border="1"> <thead> <tr> <th colspan="2">SC Series</th> </tr> </thead> <tbody> <tr> <td>DN DIL N type</td> <td>RoHS = 100% tinned phosphor bronze, non magnetic. Lead status: 0% Pb.</td> </tr> <tr> <td>DJ DIL J type</td> <td>Non RoHS = Sn (60%) Pb (40%) plated phosphor bronze, non magnetic. Lead status: Pb 40% of the plated layer.</td> </tr> <tr> <td>DL DIL L type</td> <td></td> </tr> <tr> <td>RL Ribbon L type</td> <td>RoHS = 100% tinned copper, non magnetic. Lead status: 0% Pb</td> </tr> <tr> <td>RJ Ribbon J type</td> <td></td> </tr> <tr> <td>W4 Radial 4 wires</td> <td>RoHS = 100% tinned copper, non magnetic. Lead status: 0% Pb. Non RoHS = Sn (70%) Pb (30%) plated Copper, non magnetic. Lead status: Pb 30% of the plated layer.</td> </tr> <tr> <th colspan="2">SV Series</th> </tr> <tr> <td>W2 Radial 2 wires</td> <td>See W4</td> </tr> </tbody> </table>	SC Series		DN DIL N type	RoHS = 100% tinned phosphor bronze, non magnetic. Lead status: 0% Pb.	DJ DIL J type	Non RoHS = Sn (60%) Pb (40%) plated phosphor bronze, non magnetic. Lead status: Pb 40% of the plated layer.	DL DIL L type		RL Ribbon L type	RoHS = 100% tinned copper, non magnetic. Lead status: 0% Pb	RJ Ribbon J type		W4 Radial 4 wires	RoHS = 100% tinned copper, non magnetic. Lead status: 0% Pb. Non RoHS = Sn (70%) Pb (30%) plated Copper, non magnetic. Lead status: Pb 30% of the plated layer.	SV Series		W2 Radial 2 wires	See W4	- = uncoated and no marking U = uncoated and marked C = coated and marked	- = non-RoHS compliant Both RoHS and non-RoHS versions exist. This is due to the wishes of some customers who still need non-RoHS components in their applications. This suffix must be required for RoHS compliancy.
SC Series																										
DN DIL N type	RoHS = 100% tinned phosphor bronze, non magnetic. Lead status: 0% Pb.																									
DJ DIL J type	Non RoHS = Sn (60%) Pb (40%) plated phosphor bronze, non magnetic. Lead status: Pb 40% of the plated layer.																									
DL DIL L type																										
RL Ribbon L type	RoHS = 100% tinned copper, non magnetic. Lead status: 0% Pb																									
RJ Ribbon J type																										
W4 Radial 4 wires	RoHS = 100% tinned copper, non magnetic. Lead status: 0% Pb. Non RoHS = Sn (70%) Pb (30%) plated Copper, non magnetic. Lead status: Pb 30% of the plated layer.																									
SV Series																										
W2 Radial 2 wires	See W4																									

# SC / SV Series

## High Capacitance Stacked Capacitors

### DIMENSIONS in inches (mm)

#### SC SERIES

4 wires W4 terminations

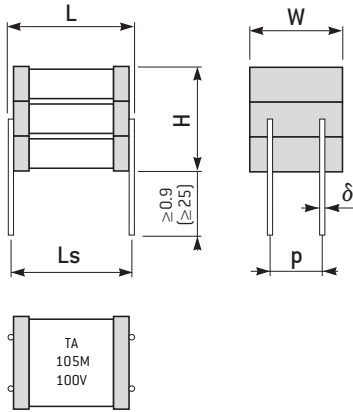

#### SC SERIES

Dual In Line DIL termination

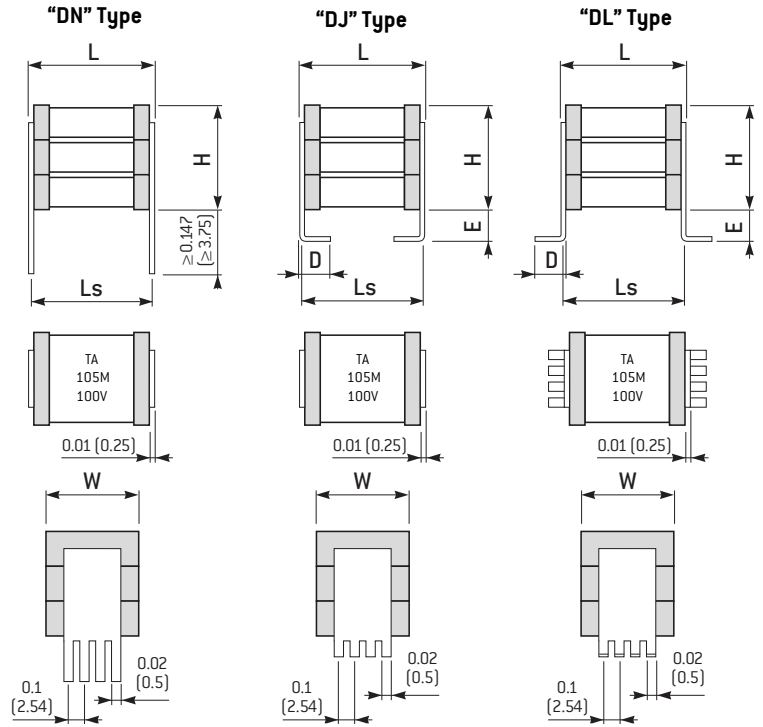

Note: the marking shown here is just given as an example

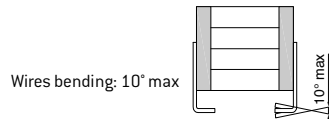

Size	L max.	W max.	Ls ± 0.02 (±0.5)	p ± 0.02 (±0.5)	δ ± 10%	H max.
SC02	0.469 (11.9)	0.449 (11.4)	0.400 (10.16)	0.300 (7.62)	0.024 (0.6)	
SC04	0.650 (16.5)	0.552 (14)	0.600 (15.24)	0.400 (10.16)	0.035 (0.9)	
SC05	0.788 (20)	0.654 (16.6)	0.701 (17.8)	0.400 (10.16)	0.035 (0.9)	
SC06	0.701 (17.8)	0.851 (21.6)	0.600 (15.24)	0.400 (10.16)	0.035 (0.9)	
SC07	0.894 (22.7)	0.654 (16.6)	0.800 (20.32)	0.400 (10.16)	0.035 (0.9)	

Please, consult the tables of standard ratings

Size	L max.	W max.	Ls ± 0.02* (±0.5)*	E ± 0.012 (±0.5)	D ± 0.02 (±0.5)	Number of leads per side	H max.
SC00	0.300 (7.62)	0.276 (7)	0.250 (6.35)	0.021 (1.8)	0.029 (2)	3	
SC01	0.402 (10.2)	0.328 (9.6)	0.300 (7.62)	0.059 (1.5)	0.098 (2.5)	3	
SC02	0.469 (11.9)	0.449 (11.4)	0.400 (10.16)	0.059 (1.5)	0.098 (2.5)	4	
SC04	0.650 (16.5)	0.552 (14)	0.539 (13.7)	0.059 (1.5)	0.098 (2.5)	5	
SC05	0.729 (18.5)	0.670 (17)	0.700 (17.78)	0.059 (1.5)	0.098 (2.5)	6	
SC06	0.701 (17.8)	0.851 (21.6)	0.600 (15.24)	0.059 (1.5)	0.098 (2.5)	7	
SC07	0.894 (22.7)	0.654 (16.6)	0.800 (20.32)	0.059 (1.5)	0.098 (2.5)	6	
SC10	0.520 (13.2)	1.083 (27.5)	0.453 (11.5)	0.083 (2.1)	0.102 (2.6)	10	
SC12	0.945 (24)	1.598 (40.6)	0.800 (20.32)	0.098 (2.5)	0.098 (2.5)	14	

Please, consult the tables of standard ratings

\* Except for the SC07, tolerance = ± 0.032 in (± 0.8mm).

# High Capacitance Stacked Capacitors

# SC / SV Series

## DIMENSIONS in inches (mm)

### SC SERIES

Ribbons R terminations

RJ Type (upon request)

RL Type (standard)

### SV SERIES

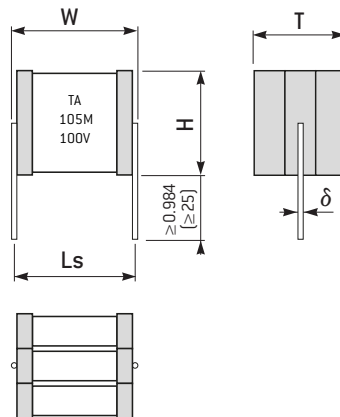
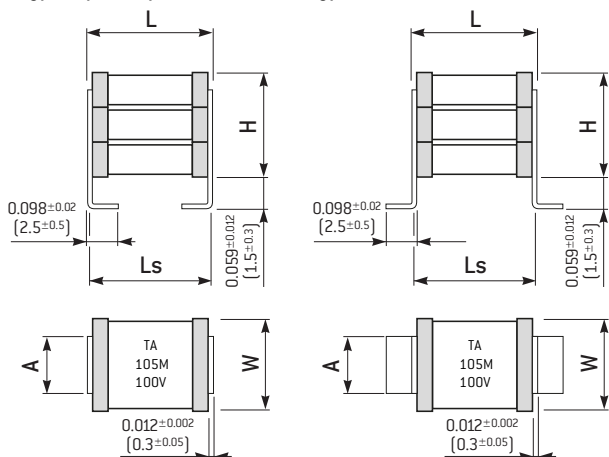

Note: the marking shown here is just given as an example. For the «RJ» version, please consult us.

HIGH CAPACITANCE

Size	L max.	W max.	A ± 0.008 [± 0.2]	Ls ± 0.02 [± 0.5]	H max.
SC01	0.402 [10.2]	0.378 [9.6]	0.315 [8]	0.415 [10.55]	Please, consult the tables of standard ratings
SC02	0.469 [11.9]	0.449 [11.4]	0.315 [8]	0.482 [12.25]	
SC04	0.650 [16.5]	0.552 [14]	0.315 [8]	0.663 [16.85]	
SC05	0.729 [18.5]	0.670 [17]	0.591 [15]	0.742 [18.85]	
SC06	0.701 [17.8]	0.851 [21.6]	0.591 [15]	0.715 [18.15]	
SC07	0.894 [22.7]	0.654 [16.6]	0.591 [15]	0.907 [23.05]	

Size	W max.	H max.	LS ± 0.02 [± 0.5]	$\delta$ ± 10%	T max.
SV01	0.402 [10.2]	0.378 [9.6]	0.400 [10.16]	0.024 [0.6]	Please, consult the tables of standard ratings
SV02	0.469 [11.9]	0.449 [11.4]	0.400 [10.16]	0.024 [0.6]	
SV04	0.650 [16.5]	0.552 [14]	0.600 [15.24]	0.035 [0.9]	
SV05	0.788 [20]	0.654 [16.6]	0.701 [17.8]	0.035 [0.9]	
SV06	0.701 [17.8]	0.851 [21.6]	0.600 [15.24]	0.035 [0.9]	
SV07	0.894 [22.7]	0.654 [16.6]	0.800 [20.32]	0.035 [0.9]	

# SC / SV Series

## High Capacitance Stacked Capacitors

### STANDARD RATINGS

Exxelia size code	2225								3033								Cap. code
	SC00								SC01 / SV01								
	50 V		100 V		200 V		500 V		50 V		100 V		200 V		500 V		
Dielectric code	X	T	X	T	X	T	X	T	X	T	X	T	X	T	X	T	
	47 nF							0.118 (3)								0.083 (2.1)	
56							0.118 (3)								0.083 (2.1)		563
68							0.118 (3)								0.083 (2.1)		683
82							0.118 (3)								0.083 (2.1)		823
100					0.039 (1.8)		0.118 (3)	0.079 (2.3)					0.083 (2.1)		0.098 (2.5)	0.102 (2.6)	104
120					0.039 (1.8)		0.118 (3)	0.079 (2.3)					0.083 (2.1)		0.098 (2.5)	0.102 (2.6)	124
150					0.079 (2)		0.252 (6.4)	0.079 (2.3)					0.083 (2.1)		0.098 (2.5)	0.102 (2.6)	154
180	0.039 (1.8)		0.039 (1.8)		0.079 (2)		0.252 (6.4)	0.102 (2.6)	0.083 (2.1)		0.083 (2.1)		0.083 (2.1)		0.126 (3.2)	0.102 (2.6)	184
220	0.039 (1.8)		0.039 (1.8)		0.098 (2.5)		0.252 (6.4)	0.110 (2.8)	0.083 (2.1)		0.083 (2.1)		0.083 (2.1)		0.126 (3.2)	0.102 (2.6)	224
270	0.039 (1.8)		0.039 (1.8)		0.098 (2.5)	0.079 (2.3)	0.378 (9.6)	0.122 (3.1)	0.083 (2.1)		0.083 (2.1)		0.083 (2.1)		0.138 (3.5)	0.102 (2.6)	274
330	0.039 (1.8)		0.039 (1.8)		0.118 (3)	0.079 (2.3)	0.378 (9.6)	0.252 (6.4)	0.083 (2.1)		0.083 (2.1)		0.083 (2.1)		0.241 (6.1)	0.110 (2.8)	334
390	0.039 (1.8)		0.039 (1.8)		0.118 (3)	0.079 (2.3)	0.504 (12.8)	0.252 (6.4)	0.083 (2.1)		0.083 (2.1)		0.083 (2.1)		0.241 (6.1)	0.122 (3.1)	394
470	0.039 (1.8)		0.039 (1.8)		0.213 (5.4)	0.079 (2.3)	0.504 (12.8)	0.252 (6.4)	0.083 (2.1)		0.083 (2.1)		0.083 (2.1)	0.079 (2.3)	0.272 (6.9)	0.138 (3.5)	474
560	0.079 (2)		0.079 (2)		0.232 (5.9)	0.098 (2.5)	0.551 (14)	0.252 (6.4)	0.083 (2.1)		0.083 (2.1)		0.098 (2.5)	0.079 (2.3)	0.414 (10.5)	0.237 (6)	564
680	0.079 (2)	0.079 (2.3)	0.079 (2)	0.079 (2.3)	0.252 (6.4)	0.110 (2.8)	0.630 (16)	0.382 (9.7)	0.083 (2.1)		0.083 (2.1)		0.118 (3)	0.079 (2.3)	0.414 (10.5)	0.249 (6.3)	684
820	0.079 (2)	0.079 (2.3)	0.079 (2)	0.079 (2.3)	0.319 (8.1)	0.197 (5)	0.709 (18)	0.382 (9.7)	0.083 (2.1)		0.083 (2.1)		0.138 (3.5)	0.094 (2.4)	0.548 (13.9)	0.260 (6.6)	824
1 μF	0.087 (2.2)	0.079 (2.3)	0.087 (2.2)	0.079 (2.3)	0.378 (9.6)	0.213 (5.4)		0.512 (13)	0.098 (2.5)		0.098 (2.5)		0.174 (4.4)	0.102 (2.6)	0.583 (14.8)	0.292 (7.4)	105
1.2	0.098 (2.5)	0.079 (2.3)	0.098 (2.5)	0.079 (2.3)	0.504 (12.8)	0.236 (6)			0.098 (2.5)		0.098 (2.5)		0.213 (5.4)	0.114 (2.9)	0.669 (17.6)	0.390 (9.9)	125
1.5	0.118 (3)	0.079 (2.3)	0.118 (3)	0.079 (2.3)	0.551 (14)	0.315 (8.1)			0.110 (2.8)	0.079 (2.3)	0.110 (2.8)	0.079 (2.3)	0.260 (6.6)	0.134 (3.4)		0.438 (11.1)	155
1.8	0.173 (4.4)	0.079 (2.3)	0.173 (4.4)	0.079 (2.3)	0.630 (16.4)	0.354 (9)			0.110 (2.8)	0.079 (2.3)	0.110 (2.8)	0.079 (2.3)	0.347 (8.8)	0.256 (6.5)		0.583 (14.8)	185
2.2	0.197 (5.1)	0.102 (2.6)	0.197 (5.1)	0.102 (2.6)	0.630 (16.4)	0.394 (10.8)			0.110 (2.8)	0.079 (2.3)	0.110 (2.8)	0.079 (2.3)	0.426 (10.8)	0.256 (6.5)		0.630 (16)	225
2.7	0.232 (5.9)	0.114 (2.9)	0.232 (5.9)	0.114 (2.9)		0.472 (12)			0.130 (3.3)	0.094 (2.4)	0.130 (3.3)	0.094 (2.4)	0.552 (14)	0.256 (6.5)			275
3.3	0.296 (7.5)	0.197 (5)	0.296 (7.5)	0.197 (5)		0.535 (13.6)			0.150 (3.8)	0.098 (2.5)	0.150 (3.8)	0.098 (2.5)	0.591 (15)	0.367 (9.3)			335
3.9	0.339 (8.6)	0.209 (5.3)	0.339 (8.6)	0.209 (5.3)					0.237 (6)	0.110 (2.8)	0.237 (6)	0.110 (2.8)		0.394 (10)			395
4.7	0.378 (9.6)	0.232 (5.9)	0.378 (9.6)	0.232 (5.9)					0.237 (6)	0.122 (3.1)	0.237 (6)	0.122 (3.1)		0.489 (12.4)			475
5.6	0.484 (12.3)	0.244 (6.2)	0.484 (12.3)	0.244 (6.2)					0.276 (7)	0.205 (5.2)	0.276 (7)	0.205 (5.2)		0.536 (13.6)			565
6.8	0.504 (12.8)	0.335 (8.5)	0.504 (12.8)	0.335 (8.5)					0.315 (8)	0.213 (5.4)	0.315 (8)	0.213 (5.4)					685
8.2	0.630 (16)	0.343 (8.7)	0.630 (16)	0.343 (8.7)					0.434 (11)	0.237 (6)	0.434 (11)	0.237 (6)					825
10		0.472 (12.2)		0.472 (12.2)					0.473 (12)	0.319 (8.1)	0.473 (12)	0.319 (8.1)					106
12		0.472 (12.2)		0.472 (12.2)					0.552 (14)	0.355 (9)	0.552 (14)	0.355 (9)					126
15										0.473 (12)		0.473 (12)					156
18										0.520 (13.2)		0.520 (13.2)					186

The thickness H max in inches (in mm) for the SC Series or the height T max in inches (in mm) for the SV Series is indicated in the cells.

# High Capacitance Stacked Capacitors

# SC / SV Series

## STANDARD RATINGS

Exxelia size code	3740								5550								Cap. code	
	SC02 / SV02								SC04 / SV04									
	50 V		100 V		200 V		500 V		50 V		100 V		200 V		500 V			
Dielectric code	X	T	X	T	X	T	X	T	X	T	X	T	X	T	X	T		
100 nF								0.118 (3)										104
120								0.118 (3)										124
150								0.118 (3)										154
180					0.083 (2.1)		0.118 (3)	0.102 (2.6)										184
220					0.083 (2.1)		0.118 (3)	0.102 (2.6)										224
270					0.083 (2.1)		0.118 (3)	0.102 (2.6)						0.098 (2.5)	0.102 (2.6)			274
330	0.083 (2.1)		0.083 (2.1)		0.083 (2.1)		0.130 (3.3)	0.102 (2.6)						0.098 (2.5)	0.102 (2.6)			334
390	0.083 (2.1)		0.083 (2.1)		0.083 (2.1)		0.138 (3.5)	0.102 (2.6)						0.098 (2.5)	0.102 (2.6)			394
470	0.083 (2.1)		0.083 (2.1)		0.083 (2.1)		0.157 (4)	0.102 (2.6)						0.118 (3)	0.102 (2.6)			474
560	0.083 (2.1)		0.083 (2.1)		0.083 (2.1)		0.169 (4.3)	0.114 (2.9)						0.118 (3)	0.102 (2.6)			564
680	0.083 (2.1)		0.083 (2.1)		0.098 (2.5)		0.276 (7)	0.134 (3.4)						0.118 (3)	0.102 (2.6)			684
820	0.083 (2.1)		0.083 (2.1)		0.098 (2.5)	0.079 (2.3)	0.390 (9.9)	0.150 (3.8)					0.118 (3)	0.138 (3.5)	0.102 (2.6)			824
1 μF	0.083 (2.1)		0.083 (2.1)		0.118 (3)	0.079 (2.3)	0.406 (10.3)	0.245 (6.2)					0.118 (3)	0.165 (4.2)	0.110 (2.8)			105
1.2	0.083 (2.1)		0.083 (2.1)		0.138 (3.5)	0.079 (2.3)	0.552 (14)	0.245 (6.2)					0.118 (3)	0.102 (2.6)	0.252 (6.4)	0.130 (3.3)		125
1.5	0.083 (2.1)	0.079 (2.3)	0.083 (2.1)	0.079 (2.3)	0.157 (4)	0.102 (2.6)	0.630 (16)	0.300 (7.6)					0.118 (3)	0.102 (2.6)	0.378 (9.6)	0.142 (3.6)		155
1.8	0.098 (2.5)	0.079 (2.3)	0.098 (2.5)	0.079 (2.3)	0.233 (5.9)	0.111 (2.8)	0.709 (18)	0.315 (8)	0.098 (2.5)		0.098 (2.5)		0.118 (3)	0.102 (2.6)	0.378 (9.6)	0.157 (4.1)		185
2.2	0.098 (2.5)	0.079 (2.3)	0.098 (2.5)	0.079 (2.3)	0.252 (6.4)	0.126 (3.2)	0.709 (18)	0.426 (10.8)	0.098 (2.5)		0.098 (2.5)		0.118 (3)	0.102 (2.6)	0.378 (9.6)	0.256 (6.5)		225
2.7	0.110 (2.8)	0.079 (2.3)	0.110 (2.8)	0.079 (2.3)	0.252 (6.4)	0.142 (3.6)		0.567 (14.4)	0.098 (2.5)		0.098 (2.5)		0.138 (3.5)	0.102 (2.6)	0.504 (12.8)	0.288 (7.3)		275
3.3	0.110 (2.8)	0.079 (2.3)	0.110 (2.8)	0.079 (2.3)	0.378 (9.6)	0.229 (5.8)		0.630 (16)	0.098 (2.5)	0.102 (2.6)	0.098 (2.5)	0.102 (2.6)	0.157 (4)	0.111 (2.8)	0.583 (14.8)	0.319 (8.1)		335
3.9	0.130 (3.3)	0.079 (2.3)	0.130 (3.3)	0.079 (2.3)	0.378 (9.6)	0.252 (6.4)			0.098 (2.5)	0.102 (2.6)	0.098 (2.5)	0.102 (2.6)	0.252 (6.4)	0.122 (3.1)	0.662 (16.8)	0.438 (11.1)		395
4.7	0.138 (3.5)	0.079 (2.3)	0.138 (3.5)	0.079 (2.3)	0.504 (12.8)	0.284 (7.2)			0.118 (3)	0.102 (2.6)	0.118 (3)	0.102 (2.6)	0.378 (9.6)	0.138 (3.5)		0.449 (11.4)		475
5.6	0.142 (3.6)	0.102 (2.6)	0.142 (3.6)	0.102 (2.6)	0.630 (16)	0.300 (7.6)			0.118 (3)	0.102 (2.6)	0.118 (3)	0.102 (2.6)	0.378 (9.6)	0.221 (5.6)		0.587 (14.9)		565
6.8	0.185 (4.7)	0.118 (3)	0.185 (4.7)	0.118 (3)	0.709 (18)	0.418 (10.6)			0.118 (3)	0.102 (2.6)	0.118 (3)	0.102 (2.6)	0.434 (11)	0.237 (6)		0.658 (16.7)		685
8.2	0.284 (7.2)	0.142 (3.6)	0.284 (7.2)	0.142 (3.6)		0.449 (11.4)			0.138 (3.5)	0.102 (2.6)	0.138 (3.5)	0.102 (2.6)	0.438 (11.1)	0.252 (6.4)				825
10	0.292 (7.4)	0.197 (5)	0.292 (7.4)	0.197 (5)		0.583 (14.8)			0.150 (3.8)	0.102 (2.6)	0.150 (3.8)	0.102 (2.6)	0.497 (12.6)	0.371 (9.4)				106
12	0.414 (10.5)	0.221 (5.6)	0.414 (10.5)	0.221 (5.6)					0.252 (6.4)	0.111 (2.8)	0.252 (6.4)	0.111 (2.8)	0.630 (16)	0.390 (9.9)				126
15	0.438 (11.1)	0.308 (7.8)	0.438 (11.1)	0.308 (7.8)					0.284 (7.2)	0.126 (3.2)	0.319 (8.1)	0.126 (3.2)		0.520 (13.2)				156
18	0.583 (14.8)	0.347 (8.8)	0.583 (14.8)	0.347 (8.8)					0.304 (7.7)	0.221 (5.6)	0.394 (10.8)	0.221 (5.6)		0.567 (14.4)				186
22	0.598 (15.2)	0.402 (10.2)	0.598 (15.2)	0.402 (10.2)					0.315 (8)	0.229 (5.8)	0.504 (12.8)	0.229 (5.8)						226
27		0.441 (11.2)		0.441 (11.2)					0.461 (11.7)	0.245 (6.2)	0.504 (12.8)	0.245 (6.2)						276
33		0.591 (15)		0.591 (15)					0.473 (12)	0.339 (8.6)	0.583 (14.8)	0.339 (8.6)						336
39		0.630 (16)		0.630 (16)					0.630 (16)	0.371 (9.4)	0.662 (16.8)	0.371 (9.4)						396
47										0.473 (12)		0.473 (12)						476
56										0.536 (13.6)		0.536 (13.6)						566

The thickness H max in inches (in mm) for the SC Series or the height T max in inches (in mm) for the SV Series is indicated in the cells.

HIGH CAPACITANCE

# SC / SV Series

## High Capacitance Stacked Capacitors

### STANDARD RATINGS

Exxelia size code	6560								6080 / 8060								Cap. code
	SC05 / SV05								SC06 / SC07 - SV06 / SV07								
	50 V		100 V		200 V		500 V		50 V		100 V		200 V		500 V		
Dielectric code	X	T	X	T	X	T	X	T	X	T	X	T	X	T	X	T	
	270 nF							0.098 (2.5)	0.102 (2.6)								
330							0.098 (2.5)	0.102 (2.6)									334
390							0.098 (2.5)	0.102 (2.6)									394
470							0.098 (2.5)	0.102 (2.6)							0.118 (3)		474
560						0.098 (2.5)	0.098 (2.5)	0.102 (2.6)							0.118 (3)		564
680						0.098 (2.5)	0.098 (2.5)	0.102 (2.6)							0.118 (3)	0.102 (2.6)	684
820						0.098 (2.5)	0.118 (3)	0.102 (2.6)							0.118 (3)	0.102 (2.6)	824
1 μF	0.098 (2.5)		0.098 (2.5)		0.098 (2.5)	0.102 (2.6)	0.118 (3)	0.102 (2.6)							0.118 (3)	0.102 (2.6)	105
1.2	0.098 (2.5)		0.098 (2.5)		0.098 (2.5)	0.102 (2.6)	0.138 (3.5)	0.102 (2.6)							0.138 (3.5)	0.102 (2.6)	125
1.5	0.098 (2.5)		0.098 (2.5)		0.098 (2.5)	0.102 (2.6)	0.157 (4)	0.118 (3)					0.118 (3)		0.157 (4)	0.102 (2.6)	155
1.8	0.098 (2.5)		0.098 (2.5)		0.098 (2.5)	0.102 (2.6)	0.177 (4.5)	0.118 (3)					0.118 (3)		0.177 (4.5)	0.102 (2.6)	185
2.2	0.098 (2.5)		0.098 (2.5)		0.098 (2.5)	0.102 (2.6)	0.272 (6.9)	0.130 (3.3)					0.118 (3)	0.102 (2.6)	0.272 (6.9)	0.102 (2.6)	225
2.7	0.098 (2.5)	0.102 (2.6)	0.098 (2.5)	0.102 (2.6)	0.118 (3)	0.102 (2.6)	0.312 (7.9)	0.150 (3.8)					0.118 (3)	0.102 (2.6)	0.378 (9.6)	0.130 (3.3)	275
3.3	0.098 (2.5)	0.102 (2.6)	0.098 (2.5)	0.102 (2.6)	0.118 (3)	0.102 (2.6)	0.331 (8.4)	0.169 (4.3)					0.118 (3)	0.102 (2.6)	0.398 (10.1)	0.154 (3.9)	335
3.9	0.098 (2.5)	0.102 (2.6)	0.098 (2.5)	0.102 (2.6)	0.138 (3.5)	0.102 (2.6)	0.438 (11.1)	0.264 (6.7)	0.118 (3)		0.118 (3)		0.138 (3.5)	0.102 (2.6)	0.504 (12.8)	0.173 (4.4)	395
4.7	0.098 (2.5)	0.102 (2.6)	0.098 (2.5)	0.102 (2.6)	0.157 (4)	0.102 (2.6)	0.497 (12.6)	0.296 (7.5)	0.118 (3)		0.118 (3)		0.157 (4)	0.102 (2.6)	0.583 (14.8)	0.249 (6.3)	475
5.6	0.098 (2.5)	0.102 (2.6)	0.098 (2.5)	0.102 (2.6)	0.233 (5.9)	0.114 (2.9)	0.662 (16.8)	0.335 (8.5)	0.118 (3)		0.118 (3)		0.252 (6.4)	0.102 (2.6)	0.583 (14.8)	0.276 (7)	565
6.8	0.098 (2.5)	0.102 (2.6)	0.098 (2.5)	0.102 (2.6)	0.252 (6.4)	0.130 (3.3)	0.819 (20.8)	0.355 (9)	0.118 (3)	0.102 (2.6)	0.118 (3)	0.102 (2.6)	0.252 (6.4)	0.118 (3)	0.661 (16.8)	0.319 (8.1)	685
8.2	0.118 (3)	0.102 (2.6)	0.118 (3)	0.102 (2.6)	0.359 (9.1)	0.150 (3.8)		0.473 (12)	0.118 (3)	0.102 (2.6)	0.118 (3)	0.102 (2.6)	0.378 (9.6)	0.142 (3.6)	0.740 (18.8)	0.386 (9.8)	825
10	0.118 (3)	0.102 (2.6)	0.118 (3)	0.102 (2.6)	0.378 (9.6)	0.233 (5.9)		0.532 (13.5)	0.138 (3.5)	0.102 (2.6)	0.138 (3.5)	0.102 (2.6)	0.378 (9.6)	0.220 (5.6)		0.485 (12.3)	106
12	0.138 (3.5)	0.102 (2.6)	0.138 (3.5)	0.102 (2.6)	0.504 (12.8)	0.260 (6.6)		0.689 (17.5)	0.138 (3.5)	0.102 (2.6)	0.138 (3.5)	0.102 (2.6)	0.504 (12.8)	0.236 (6)		0.595 (15.1)	126
15	0.157 (4)	0.102 (2.6)	0.157 (4)	0.102 (2.6)	0.583 (14.8)	0.296 (7.5)			0.138 (3.5)	0.102 (2.6)	0.138 (3.5)	0.102 (2.6)	0.504 (12.8)	0.276 (7)		0.725 (18.4)	156
18	0.252 (6.4)	0.102 (2.6)	0.252 (6.4)	0.102 (2.6)		0.398 (10.1)			0.146 (3.7)	0.102 (2.6)	0.146 (3.7)	0.102 (2.6)	0.630 (16)	0.347 (8.8)			186
22	0.252 (6.4)	0.118 (3)	0.252 (6.4)	0.118 (3)		0.434 (11)			0.252 (6.4)	0.110 (2.8)	0.291 (7.4)	0.110 (2.8)	0.740 (18.8)	0.362 (9.2)			226
27	0.312 (7.9)	0.142 (3.6)	0.378 (9.6)	0.142 (3.6)		0.552 (14)			0.252 (6.4)	0.130 (3.3)	0.323 (8.2)	0.130 (3.3)	0.740 (18.8)	0.504 (12.8)			276
33	0.331 (8.4)	0.220 (5.6)	0.378 (9.6)	0.220 (5.6)		0.630 (16)			0.280 (7.1)	0.220 (5.6)	0.413 (10.5)	0.220 (5.6)		0.598 (15.2)			336
39	0.457 (11.6)	0.237 (6)	0.504 (12.8)	0.237 (6)					0.378 (9.6)	0.228 (5.8)	0.441 (11.2)	0.228 (5.8)		0.630 (16)			396
47	0.497 (12.6)	0.276 (7)	0.504 (12.8)	0.276 (7)					0.378 (9.6)	0.256 (6.5)	0.465 (11.8)	0.256 (6.5)					476
56	0.662 (16.8)	0.347 (8.8)	0.669 (17)	0.347 (8.8)					0.457 (11.6)	0.347 (8.8)	0.472 (12)	0.347 (8.8)					566
68		0.378 (9.6)		0.378 (9.6)					0.583 (14.8)	0.354 (9)	0.591 (15)	0.354 (9)					686
82		0.504 (12.8)		0.504 (12.8)						0.465 (11.8)		0.465 (11.8)					826
100		0.575 (14.6)		0.575 (14.6)						0.768 (19.5)		0.768 (19.5)					107

The thickness H max in inches (in mm) for the SC Series or the height T max in inches (in mm) for the SV Series is indicated in the cells.

High Capacitance Stacked Capacitors

SC / SV Series

STANDARD RATINGS

Exxelia size code	45107								45214				80150				125205				Cap. code
	SC10								SC11				SC12				SC18				
	50 V		100 V		200 V		500 V		50 V	100 V	200 V	500 V	50 V	100 V	200 V	500 V	50 V	100 V	200 V	500 V	
Dielectric code	X	T	X	T	X	T	X	T	X	X	X	X	X	X	X	X	X	X	X	X	
	680 nF							0.138 (3.5)	0.122 (3.1)												
820					0.118 (3)	0.118 (3)	0.138 (3.5)	0.122 (3.1)													824
1 μF	0.118 (3)		0.118 (3)		0.118 (3)	0.118 (3)	0.150 (3.8)	0.122 (3.1)													105
1.2	0.118 (3)		0.118 (3)		0.118 (3)	0.118 (3)	0.150 (3.8)	0.122 (3.1)													125
1.5	0.118 (3)	0.118 (3)	0.118 (3)	0.118 (3)	0.118 (3)	0.118 (3)	0.252 (6.4)	0.122 (3.1)													155
1.8	0.118 (3)	0.118 (3)	0.118 (3)	0.118 (3)	0.118 (3)	0.118 (3)	0.252 (6.4)	0.122 (3.1)													185
2.2	0.118 (3)	0.118 (3)	0.118 (3)	0.118 (3)	0.138 (3.5)	0.118 (3)	0.252 (6.4)	0.122 (3.1)													225
2.7	0.118 (3)	0.118 (3)	0.118 (3)	0.118 (3)	0.150 (3.8)	0.118 (3)	0.292 (7.4)	0.122 (3.1)				*					0.157 (4)				275
3.3	0.118 (3)	0.118 (3)	0.118 (3)	0.118 (3)	0.157 (4)	0.118 (3)	0.378 (9.6)	0.331 (8.4)				*					0.157 (4)				335
3.9	0.118 (3)	0.118 (3)	0.118 (3)	0.118 (3)	0.213 (5.4)	0.118 (3)	0.504 (12.8)	0.331 (8.4)				*					0.157 (4)				395
4.7	0.118 (3)	0.118 (3)	0.118 (3)	0.118 (3)	0.233 (5.9)	0.118 (3)	0.583 (14.8)	0.331 (8.4)				*					0.157 (4)				475
5.6	0.118 (3)	0.118 (3)	0.118 (3)	0.118 (3)	0.252 (6.4)	0.118 (3)	0.583 (14.8)	0.331 (8.4)				*					0.315 (8)				565
6.8	0.118 (3)	0.118 (3)	0.118 (3)	0.118 (3)	0.319 (8.1)	0.252 (6.4)	0.662 (16.8)	0.331 (8.4)				*					0.315 (8)				685
8.2	0.118 (3)	0.118 (3)	0.118 (3)	0.118 (3)	0.378 (9.6)	0.252 (6.4)		0.496 (12.6)				*	*			0.157 (4)	0.315 (8)			*	825
10	0.138 (3.5)	0.118 (3)	0.138 (3.5)	0.118 (3)	0.378 (9.6)	0.252 (6.4)		0.496 (12.6)				*	*			0.157 (4)	0.315 (8)			*	106
12	0.138 (3.5)	0.118 (3)	0.138 (3.5)	0.118 (3)	0.504 (12.8)	0.378 (9.6)		0.661 (16.8)			*	*	*			0.315 (8)	0.472 (12)			*	126
15	0.252 (6.4)	0.118 (3)	0.252 (6.4)	0.118 (3)	0.504 (12.8)	0.378 (9.6)					*	*				0.315 (8)	0.472 (12)			*	156
18	0.252 (6.4)	0.118 (3)	0.252 (6.4)	0.118 (3)	0.661 (16.8)	0.504 (12.8)					*	*			*	0.315 (8)	0.630 (16)			*	186
22	0.378 (9.6)	0.118 (3)	0.378 (9.6)	0.118 (3)		0.504 (12.8)					*	*			*	0.315 (8)	*			*	226
27	0.378 (9.6)	0.130 (3.3)	0.378 (9.6)	0.130 (3.3)		0.661 (16.8)			*	*	*				*	0.472 (12)	*			*	276
33	0.504 (12.8)	0.276 (7)	0.504 (12.8)	0.276 (7)					*	*	*				0.157 (4)	0.472 (12)	*			*	336
39	0.504 (12.8)	0.276 (7)	0.504 (12.8)	0.276 (7)					*	*				0.157 (4)	0.157 (4)	0.630 (16)			*	*	396
47	0.591 (15)	0.276 (7)	0.591 (15)	0.276 (7)					*	*				0.157 (4)	0.315 (8)	*			*	*	476
56	0.591 (15)	0.433 (11)	0.591 (15)	0.433 (11)					*	*				0.315 (8)	0.315 (8)	*			*	*	566
68		0.433 (11)		0.433 (11)					*	*				0.315 (8)	0.315 (8)				*	*	686
82		0.591 (15)		0.591 (15)					*					0.315 (8)	0.315 (8)			*	*	*	826
100									*					0.315 (8)	0.472 (12)			*	*	*	107
120									*					0.472 (12)	0.472 (12)			*	*		127
150														0.472 (12)	0.630 (16)			*	*		157
180														0.630 (16)				*	*		187
220																		*	*		227
270																		*			277
330																		*			337
390																		*			397

The thickness H max in inches (in mm) for the SC Series or the height T max in inches (in mm) for the SV Series is indicated in the cells. \* Consult us

# CNC3X Series

High Capacitance Stacked Capacitors



## FEATURES

- Multilayer chips ceramic capacitors stacked
- X7R dielectric (NPO available on request)
- Capacitance range: 1.2µF to 68µF
- Voltage range: 16 V<sub>DC</sub> to 25 V<sub>DC</sub>
- Their low operating voltage give them a major advantage as they have much higher capacitance values in the same format. These components are ideally suited to advanced digital electronic applications requiring ever lower operating voltages

## PHYSICAL CHARACTERISTICS

### CONSTRUCTION

- P, PL, L models: DIL leaded uncoated stacked chips capacitors for surface mounting recommended to eliminate thermomechanical stresses.
- N, NU models: DIL leaded stacked chips capacitors for through-hole circuits (N: varnished, NU: uncoated chips)
- They can be supplied on request in ribbon or molded configuration

### MARKING (clear or coded)

Capacitance value, tolerance, rated voltage (except 16 V).

## ELECTRICAL SPECIFICATIONS

DIELECTRIC	X7R
Maximum $\Delta C/C$ over temperature range without voltage	$\pm 15\%$
Ageing	$\leq 2.5\%$ per decade hour
Operating temperature	$-55^{\circ}\text{C} + 125^{\circ}\text{C}$
Rated voltage (U <sub>RC</sub> )	16 V <sub>DC</sub> to 25 V <sub>DC</sub>
Dielectric withstanding voltage	2.5 U <sub>RC</sub>
Capacitance	at 1kHz 0.3Vrms
Dissipation factor	$\leq 2.5\%$ at 1kHz 0.3Vrms
Insulation resistance at 25°C under U <sub>RC</sub>	$\geq 1,000 \text{ M}\Omega\mu\text{F}$

## HOW TO ORDER

CNC	33	P	W	F	6,8µF	±10%	25 V
Series	Exxelia size code	Model	RoHS Compliant	Quality level	Capacitance	Tolerance	Rated voltage
CNC	31 32 33 34	P PL L N NU	- = No RoHS W = RoHS compliant	- = standard quality level F = Hi-Rel quality: screening in accordance with Exxelia specification	Capacitance value in clear	±10% ±20%	16 V 25 V



# High Capacitance Stacked Capacitors

# CNC3X Series

## DIMENSIONS in inches (mm)

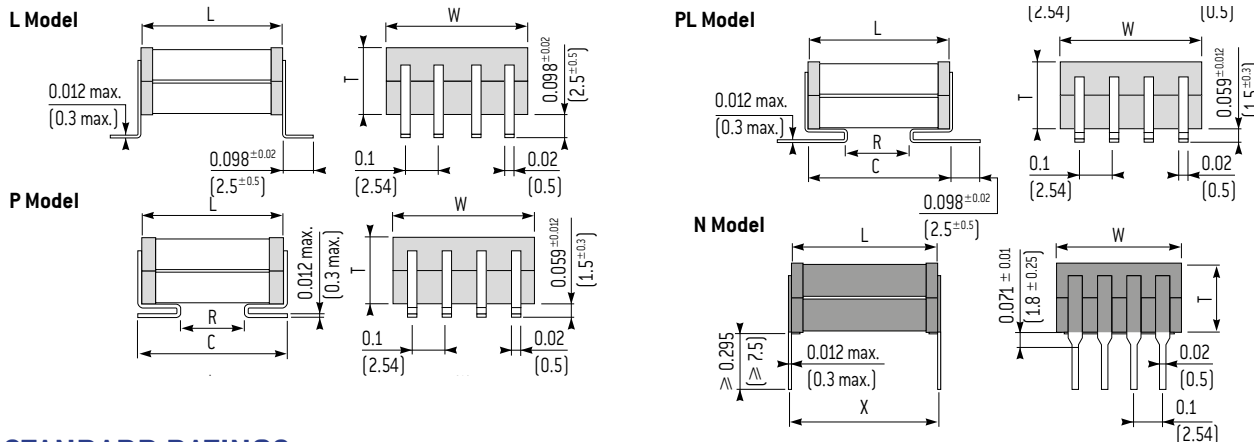

## STANDARD RATINGS

Size	Series	Dimensions inches (mm)					Leads per side	T max.		Nb. of chips	Rated Voltage		Min. cap. Value
		L max.	W max.	R min.	C max.	X		inches	(mm)		16 V	25 V	
2220	CNC31	0.296	0.237	0.098	0.296	0.2 ± 0.020	2	0.099	(2.5)	1	3.9µF	2.2µF	1.2µF
		(7.5)	(6)	(2.5)	(7.5)	(5.08 ± 0.5)		0.197	(5)		6.8µF	4.7µF	
								0.296	(7.5)		12µF	6.8µF	
2528	CNC32	0.315	0.315	0.098	0.315	0.3 ± 0.020	3	0.099	(2.5)	1	4.7µF	3.3µF	1.8µF
		(8)	(8)	(2.5)	(8)	(7.62 ± 0.5)		0.197	(5)		10µF	5.6µF	
								0.296	(7.5)		15µF	10µF	
3333	CNC33	0.394	0.363	0.137	0.394	0.3 ± 0.020	3	0.099	(2.5)	1	8.2µF	5.6µF	3.3µF
		(10)	(9.2)	(3.5)	(10)	(7.62 ± 0.5)		0.197	(5)		15µF	10µF	
								0.296	(7.5)		22µF	15µF	
								0.394	(10)		33µF	22µF	
4040	CNC34	0.493	0.473	0.196	0.493	0.4 ± 0.020	4	0.099	(2.5)	1	15µF	10µF	5.6µF
		(12.5)	(12)	(5)	(12.5)	(10.16 ± 0.5)		0.197	(5)		27µF	18µF	
								0.296	(7.5)		47µF	27µF	
								0.394	(10)		68µF	39µF	

Available capacitance values: E6, E12 (see page XX). Specific values upon request.  
The above table defines the standard products, other components may be built upon request.

## RECOMMENDED FOOTPRINT

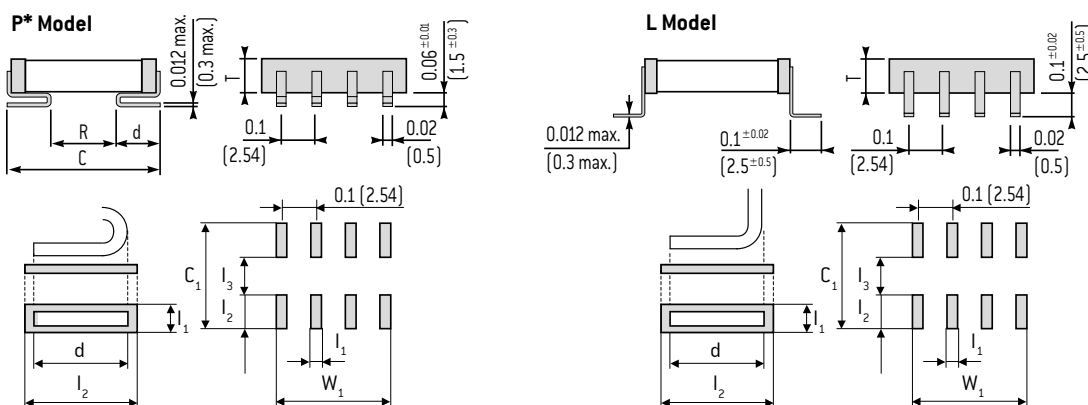

Exxelia size code	Lead shape	C max inches (mm)	Leads per side	d inches (mm)	C <sub>1</sub> inches (mm)	W <sub>1</sub> inches (mm)	I <sub>1</sub> inches (mm)	I <sub>2</sub> inches (mm)	I <sub>3</sub> inches (mm)
31	P*	0.295 (7.5)	2	0.059 ± 0.012 (1.5 ± 0.3)	0.335 (8.5)	0.147 (3.74)	0.047 (1.2)	0.128 (3.25)	0.079 (2)
	L	0.512 (13)	2	0.098 ± 0.02 (2.5 ± 0.5)	0.551 (14)	0.147 (3.74)	0.047 (1.2)	0.187 (4.75)	0.177 (4.5)
32	P*	0.315 (8)	3	0.087 ± 0.012 (2.2 ± 0.3)	0.354 (9)	0.247 (6.28)	0.047 (1.2)	0.138 (3.5)	0.079 (2)
	L	0.531 (13.5)	3	0.098 ± 0.02 (2.5 ± 0.5)	0.571 (14.5)	0.247 (6.28)	0.047 (1.2)	0.187 (4.75)	0.197 (5)
33	P*	0.394 (10)	3	0.087 ± 0.012 (2.2 ± 0.3)	0.433 (11)	0.247 (6.28)	0.047 (1.2)	0.157 (4)	0.118 (3)
	L	0.610 (15.5)	3	0.098 ± 0.02 (2.5 ± 0.5)	0.650 (16.5)	0.247 (6.28)	0.047 (1.2)	0.187 (4.75)	0.276 (7)
34	P*	0.492 (12.5)	4	0.087 ± 0.012 (2.2 ± 0.3)	0.531 (13.5)	0.347 (8.82)	0.047 (1.2)	0.177 (4.5)	0.177 (4.5)
	L	0.709 (18)	4	0.098 ± 0.02 (2.5 ± 0.5)	0.748 (19)	0.347 (8.82)	0.047 (1.2)	0.187 (4.75)	0.374 (9.5)

\* For PL : add 0.098 in (2.5 mm) to d and I2 and 0.197 in (5 mm) to C1.

# CEC5X Series

High Capacitance Stacked Capacitors

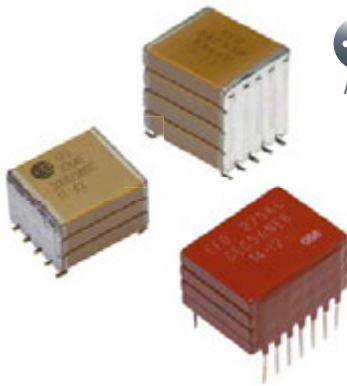

 According to  
Available space ranges:  
consult our detail  
specifications

## FEATURES

- Multilayer chips ceramic capacitors
- NPO dielectric
- Capacitance range: 10nF to 6.8μF
- Voltage range: 63 V<sub>DC</sub> to 500 V<sub>DC</sub>

## PHYSICAL CHARACTERISTICS

### CONSTRUCTION

- P, PL, L models: DIL leaded uncoated stacked chips capacitors for surface mounting recommended to eliminate thermomechanical stresses.
- N, NU models: DIL leaded stacked chips capacitors for through-hole circuits (N: varnished, NU: uncoated chips)
- They can be supplied on request in ribbon connection configuration ideally suited to iron soldering

### MARKING (clear or coded)

Series, Capacitance value, tolerance, rated voltage, date code.

## ELECTRICAL SPECIFICATIONS

DIELECTRIC	NPO
Maximum $\Delta C/T^\circ C$ over temperature range without voltage	NA
Temperature coefficient	(0 ± 30) ppm/°C
Ageing	None
Operating temperature	-55°C to +125°C
Rated voltage (U <sub>RC</sub> )	63 V <sub>DC</sub> to 500 V <sub>DC</sub>
Dielectric withstanding voltage	2.5 U <sub>RC</sub> for U <sub>RC</sub> < 500 V <sub>DC</sub> 2 U <sub>RC</sub> for U <sub>RC</sub> = 500 V <sub>DC</sub>
Capacitance	at 1kHz
Dissipation factor	≤ 0.15% at 1kHz
Insulation resistance at 25°C under U <sub>RC</sub>	≥ 1,000 MΩ.μF

## HOW TO ORDER

CEC	53	P	W	F	120nF	± 10%	200 V
Series	Excellia size code	Model	RoHS compliant	Quality level	Capacitance	Tolerance	Rated voltage
CEC	53 54 55 56 57 58 65	P PL L N NU	- = No RoHS W = RoHS compliant	- = standard quality level F = Hi-Rel quality: screening in accordance with Excellia specification	Capacitance value in clear	± 1% ± 2% ± 5% ± 10% ± 20%	63V 100V 200V 500V

# High Capacitance Stacked Capacitors

# CEC5X Series

## RECOMMENDED FOOTPRINT

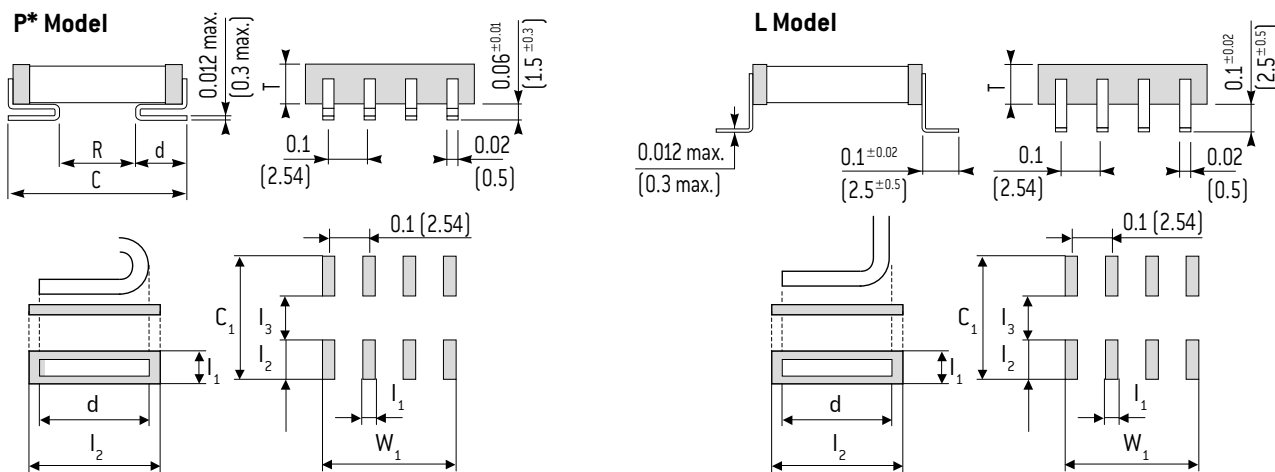

Exxelia size code	Lead shape	C max inches (mm)	Leads per side	d inches (mm)	C <sub>1</sub> inches (mm)	W <sub>1</sub> inches (mm)	l <sub>1</sub> inches (mm)	l <sub>2</sub> inches (mm)	l <sub>3</sub> inches (mm)
53	P*	0.354 (9)	3	0.087 ± 0.012 (2.2 ± 0.3)	0.394 (10)	0.247 (6.28)	0.047 (1.2)	0.146 (3.7)	0.102 (2.6)
	L	0.579 (14.7)	3	0.098 ± 0.02 (2.5 ± 0.5)	0.618 (15.7)	0.247 (6.28)	0.047 (1.2)	0.167 (4.25)	0.283 (7.2)
54	P*	0.472 (12)	4	0.087 ± 0.012 (2.2 ± 0.3)	0.512 (13)	0.347 (8.82)	0.047 (1.2)	0.187 (4.75)	0.138 (3.5)
	L	0.656 (16.66)	4	0.098 ± 0.02 (2.5 ± 0.5)	0.695 (17.66)	0.347 (8.82)	0.047 (1.2)	0.167 (4.25)	0.361 (9.16)
55	P*	0.587 (14.9)	5	0.087 ± 0.012 (2.2 ± 0.3)	0.626 (15.9)	0.447 (11.36)	0.047 (1.2)	0.175 (4.45)	0.276 (7)
	L	0.807 (20.5)	5	0.098 ± 0.02 (2.5 ± 0.5)	0.846 (21.5)	0.447 (11.36)	0.047 (1.2)	0.167 (4.25)	0.512 (13)
56	P*	0.661 (16.8)	7	0.087 ± 0.012 (2.2 ± 0.3)	0.701 (17.8)	0.647 (16.44)	0.047 (1.2)	0.163 (4.15)	0.374 (9.5)
	L	0.856 (21.74)	7	0.098 ± 0.02 (2.5 ± 0.5)	0.895 (22.74)	0.647 (16.44)	0.047 (1.2)	0.167 (4.25)	0.561 (14.24)
57	P*	0.472 (12)	14	0.087 ± 0.012 (2.2 ± 0.3)	0.512 (13)	1.347 (34.22)	0.047 (1.2)	0.163 (4.15)	0.185 (4.7)
	L	0.656 (16.66)	14	0.098 ± 0.02 (2.5 ± 0.5)	0.695 (17.66)	1.347 (34.22)	0.047 (1.2)	0.167 (4.25)	0.361 (9.16)
58	P*	0.945 (24)	14	0.087 ± 0.012 (2.2 ± 0.3)	0.984 (25)	1.347 (34.22)	0.047 (1.2)	0.163 (4.15)	0.657 (16.7)
	L	1.056 (26.82)	14	0.098 ± 0.02 (2.5 ± 0.5)	1.095 (27.82)	1.347 (34.22)	0.047 (1.2)	0.167 (4.25)	0.761 (19.32)
65	P*	0.850 (21.6)	6	0.087 ± 0.012 (2.2 ± 0.3)	0.890 (22.6)	0.547 (13.9)	0.047 (1.2)	0.163 (4.15)	0.563 (14.3)
	L	1.056 (26.82)	6	0.098 ± 0.02 (2.5 ± 0.5)	1.095 (27.82)	0.547 (13.9)	0.047 (1.2)	0.167 (4.25)	0.761 (19.32)

\* For PL : add 0.098 in (2.5 mm) to d and l<sub>2</sub> and 0.197 in (5 mm) to C<sub>1</sub>.

HIGH CAPACITANCE

# CEC5X Series

## High Capacitance Stacked Capacitors

### DIMENSIONS in inches (mm)

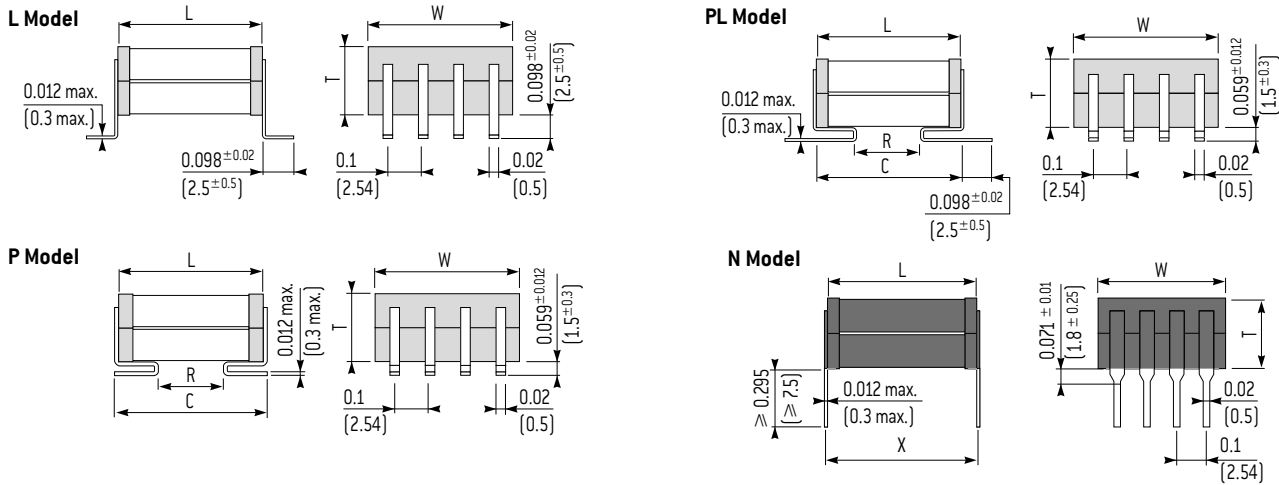

### STANDARD RATINGS

Size	3033	3740	5550	6080	40140	80150	8060			
Exxelia size code	53	54	55	56	57	58	65			
Dimensions inches (mm)	L max.	0.355 (9)	0.473 (12)	0.587 (14.9)	0.662 (16.8)	0.473 (12)	0.945 (24)	0.851 (21.6)		
	W max.	0.363 (9.2)	0.453 (11.5)	0.536 (13.6)	0.851 (21.6)	1.504 (38.2)	1.599 (40.6)	0.654 (16.6)		
	R min.	0.122 (3.1)	0.204 (5.2)	0.295 (7.5)	0.393 (10)	0.204 (5.2)	0.649 (16.5)	0.582 (14.8)		
	C max.	0.355 (9)	0.473 (12)	0.587 (14.9)	0.662 (16.8)	0.473 (12)	0.945 (24)	0.851 (21.6)		
	X	0.3 ± 0.02 (7.62 ± 0.5)	0.4 ± 0.02 (10.16 ± 0.5)	0.551 ± 0.02 (14 ± 0.5)	0.6 ± 0.02 (15.24 ± 0.5)	0.4 ± 0.02 (10.16 ± 0.5)	0.8 ± 0.02 (20.32 ± 0.5)	0.8 ± 0.02 (20.32 ± 0.5)		
Leads per side	3	4	5	7	14	14	6			
Rated voltage (U <sub>rec</sub> )	Min. Capacitance value	10nF	18nF	33nF	68nF	100nF	150nF	68nF	T max. inches (mm)	Nb. of chips
	63 V	100nF	180nF	330nF	680nF	820nF	1.8µF	680nF	0.158 (4)	1
		220nF	330nF	560nF	1.2µF	1.5µF	3.3µF	1.2µF	0.315 (8)	2
		330nF	470nF	820nF	1.8µF	2.2µF	4.7µF	1.8µF	0.473 (12)	3
		470nF	680nF	1.2µF	2.7µF	3.3µF	6.8µF	2.7µF	0.630 (16)	4
	100 V	82nF	120nF	220nF	470nF	560nF	1.2µF	470nF	0.158 (4)	1
		180nF	270nF	470nF	1µF	1.2µF	2.7µF	1µF	0.315 (8)	2
		270nF	390nF	680nF	1.5µF	1.8µF	3.9µF	1.5µF	0.473 (12)	3
		330nF	470nF	1µF	1.8µF	2.2µF	4.7µF	1.8µF	0.630 (16)	4
	200 V	56nF	82nF	180nF	330nF	390nF	820nF	330nF	0.158 (4)	1
		120nF	180nF	330nF	680nF	820nF	1.5µF	680nF	0.315 (8)	2
		180nF	270nF	470nF	1µF	1.2µF	2.7µF	1µF	0.473 (12)	3
		220nF	330nF	680nF	1.2µF	1.5µF	3.3µF	1.2µF	0.630 (16)	4
	500 V	18nF	27nF	56nF	100nF	150nF	270nF	100nF	0.158 (4)	1
		33nF	56nF	120nF	220nF	270nF	560nF	220nF	0.315 (8)	2
		56nF	100nF	180nF	330nF	390nF	820nF	330nF	0.473 (12)	3
68nF		120nF	220nF	390nF	470nF	1.2µF	390nF	0.630 (16)	4	

Available capacitance values:  
 NPO dielectric: E6, E12, E24 (see page 14). Specific values upon request.  
 The above table defines the standard products, other components may be built upon request.

# High Capacitance Stacked Capacitors

# TEP / TEV Series

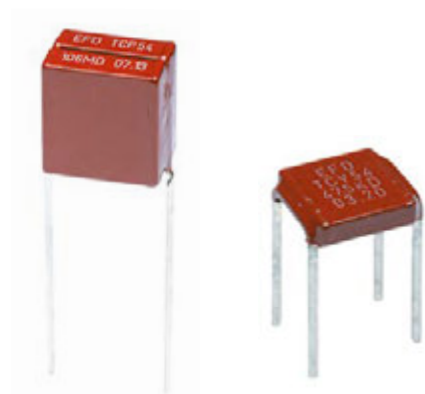

## FEATURES

- Multilayer chips ceramic capacitors
- NPO dielectric
- Capacitance range: 10nF to 2.7µF
- Voltage range: 63 V<sub>DC</sub> to 500 V<sub>DC</sub>

## PHYSICAL CHARACTERISTICS

### CONSTRUCTION

Radial leaded varnished stacked chips capacitors for through-hole circuits

### MARKING (clear or coded)

Series, Capacitance value, tolerance, rated voltage, date code.

## ELECTRICAL SPECIFICATIONS

DIELECTRIC	NPO
Maximum $\Delta C / ^\circ C$ over temperature range without voltage	NA
Temperature coefficient	$(0 \pm 30)$ ppm/ $^\circ C$
Ageing	None
Operating temperature	$-55^\circ C$ to $+125^\circ C$
Rated voltage (U <sub>RC</sub> )	63 V <sub>DC</sub> to 500 V <sub>DC</sub>
Dielectric withstanding voltage	2.5 U <sub>RC</sub> for U <sub>RC</sub> < 500 V <sub>DC</sub> 2 U <sub>RC</sub> for U <sub>RC</sub> = 500 V <sub>DC</sub>
Capacitance	at 1kHz
Dissipation factor	$\leq 0.15\%$ at 1kHz
Insulation resistance at 25°C under U <sub>RC</sub>	$\geq 1,000 M\Omega \mu F$

HIGH CAPACITANCE

## HOW TO ORDER

TEP	53	W	F	120nF	$\pm 10\%$	200 V
Series	Exxelia size code	RoHS compliant	Quality level	Capacitance	Tolerance	Rated voltage
<b>TEP</b> = radial leads vertical stack  <b>TEV</b> = radial leads horizontal stack	<b>53</b> <b>54</b> <b>55</b> <b>56</b> <b>57</b> <b>58</b> <b>65</b>	- = No RoHS  <b>W</b> = RoHS compliant	- = standard quality level  <b>F</b> = Hi-Rel quality: screening in accordance with Exxelia specification	Capacitance value in clear	<b><math>\pm 1\%</math></b> <b><math>\pm 2\%</math></b> <b><math>\pm 5\%</math></b> <b><math>\pm 10\%</math></b> <b><math>\pm 20\%</math></b>	<b>63V</b> <b>100V</b> <b>200V</b> <b>500V</b>

# TEP / TEV Series

High Capacitance Stacked Capacitors

## DIMENSIONS in inches (mm)

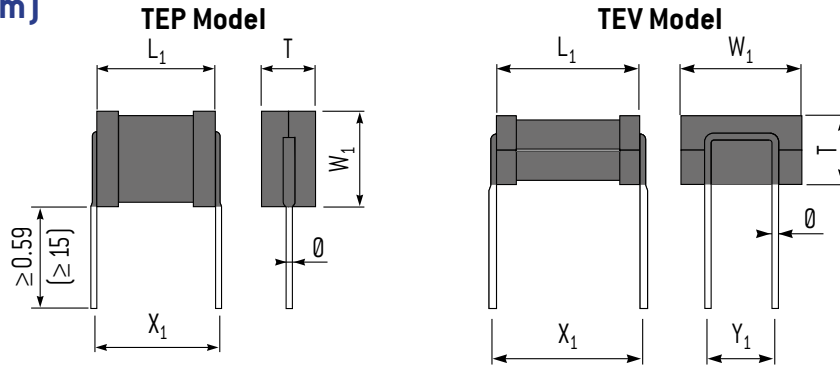

## STANDARD RATINGS

Size	3033	3740	5550	6080	40140	80150	8060			
Exxelia size code	53	54	55	56	57	58	65			
Dimensions inches (mm)	L <sub>1</sub> max.	0.418 (10.6)	0.493 (12.5)	0.623 (15.8)	0.701 (17.8)	0.556 (14.1)	0.894 (22.7)	0.894 (22.7)		
	W <sub>1</sub> max.	0.363 (9.2)	0.473 (12)	0.536 (13.6)	0.851 (21.6)	1.504 (38.2)	1.599 (40.6)	0.654 (16.6)		
	X <sub>1</sub> max.	0.323 ± 0.02 (8.2 ± 0.5)	0.4 ± 0.02 (10.16 ± 0.5)	0.579 ± 0.02 (14.7 ± 0.5)	0.6 ± 0.02 (15.24 ± 0.5)	0.4 ± 0.02 (10.16 ± 0.5)	0.835 ± 0.02 (21.2 ± 0.5)	0.835 ± 0.02 (21.2 ± 0.5)		
	Y <sub>1</sub> max.	0.2 ± 0.02 (5.08 ± 0.5)	0.3 ± 0.02 (7.62 ± 0.5)	0.3 ± 0.02 (7.62 ± 0.5)	0.6 ± 0.02 (15.24 ± 0.5)	1.1 ± 0.02 (27.94 ± 0.5)	1.2 ± 0.02 (30.48 ± 0.5)	0.4 ± 0.02 (10.16 ± 0.5)		
Leads diameter Ø		See table below								
Min. Capacitance value	10nF	18nF	33nF	68nF	100nF	150nF	68nF	T max. inches (mm)	Nb. of chips	
Rated voltage (U <sub>RC</sub> )	63 V	100nF	180nF	330nF	680nF	820nF	1.8µF	680nF	0.158 (4)	1
		220nF	330nF	560nF	1.2µF	1.5µF	3.3µF	1.2µF	0.315 (8)	2
		330nF	470nF	820nF	1.8µF	2.2µF	4.7µF	1.8µF	0.473 (12)	3
		470nF	680nF	1.2µF	2.7µF	3.3µF	6.8µF	2.7µF	0.630 (16)	4
	100 V	82nF	120nF	220nF	470nF	560nF	1.2µF	470nF	0.158 (4)	1
		180nF	270nF	470nF	1µF	1.2µF	2.7µF	1µF	0.315 (8)	2
		270nF	390nF	680nF	1.5µF	1.8µF	3.9µF	1.5µF	0.473 (12)	3
		330nF	470nF	1µF	1.8µF	2.2µF	4.7µF	1.8µF	0.630 (16)	4
	200 V	56nF	82nF	180nF	330nF	390nF	820nF	330nF	0.158 (4)	1
		120nF	180nF	330nF	680nF	820nF	1.5µF	680nF	0.315 (8)	2
		180nF	270nF	470nF	1µF	1.2µF	2.7µF	1µF	0.473 (12)	3
		220nF	330nF	680nF	1.2µF	1.5µF	3.3µF	1.2µF	0.630 (16)	4
	500 V	18nF	27nF	56nF	100nF	150nF	270nF	100nF	0.158 (4)	1
		33nF	56nF	120nF	220nF	270nF	560nF	220nF	0.315 (8)	2
		56nF	100nF	180nF	330nF	390nF	820nF	330nF	0.473 (12)	3
		68nF	120nF	220nF	390nF	470nF	1.2µF	390nF	0.630 (16)	4

Available capacitance values:  
 NPO dielectric: E6, E12, E24 (see page 14). Specific values upon request.  
 The above table defines the standard products, other components may be built upon request.

T max.	TEP 53 - TEP 54 - TEP 55	TEP 56 - TEP 65	TEV 53	TEV 54 - TEV 55 - TEV 56 - TEV 65
	Leads diameter Ø (±10%) inches (mm)			
4	0.024 (0.6)	0.031 (0.8)	0.031 (0.8)	0.039 (1)
8	0.024 (0.6)	0.031 (0.8)	0.031 (0.8)	0.039 (1)
12	0.031 (0.8)	0.039 (1)	0.031 (0.8)	0.039 (1)
16	0.031 (0.8)	0.039 (1)	0.031 (0.8)	0.039 (1)

# High Capacitance Molded Stacked Capacitors

# TCN8X Series

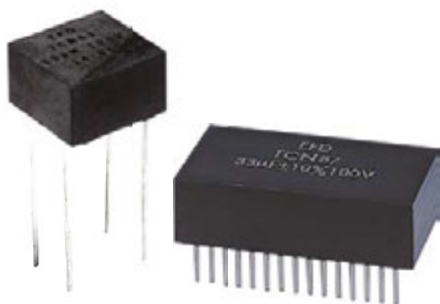

## FEATURES

- Multilayer stacked ceramic capacitors
- Epoxy resin molding
- X7R dielectric
- Capacitance range: 470nF to 120µF
- Voltage range: 50 V<sub>DC</sub> to 500 V<sub>DC</sub>

## PHYSICAL CHARACTERISTICS

### CONSTRUCTION

- TCN83/TCN86: epoxy molded (thermal and mechanical protection) capacitors with four radial leads to guarantee enhanced mechanical resistance after mounting
- TCN87: epoxy molded (thermal and mechanical protection) capacitors with DIL leads

### MARKING

Series, Capacitance value, tolerance, rated voltage, date code.

## ELECTRICAL SPECIFICATIONS

DIELECTRIC	X7R
Maximum $\Delta C/C$ over temperature range without voltage	$\leq 20\%$
Operating temperature	$-55^{\circ}\text{C} + 125^{\circ}\text{C}$
Rated voltage ( $U_{RC}$ )	50 V <sub>DC</sub> to 500 V <sub>DC</sub>
Dielectric withstanding voltage	$2 U_{RC}$
Capacitance	at 1kHz 0.3 Vrms
Dissipation factor	$\leq 2.5\%$ at 1kHz 0.3 Vrms
Insulation resistance at 25°C under $U_{RC}$	$\geq 500 \text{ M}\Omega\mu\text{F}$

HIGH CAPACITANCE

## HOW TO ORDER

TCN83	3	W	F	10µF	10%	100 V
Series	Exxelia size code	RoHS compliant	Quality level	Capacitance	Tolerance	Rated voltage
TCN83 TCN86 TCN87	Only for TCN83 and TCN86: 1 2 3 4 5	- = No RoHS W = RoHS compliant	- = standard quality level F = Hi-Rel quality: screening in accordance with Exxelia specification	Capacitance value in clear	$\pm 10\%$ $\pm 20\%$	50 V 100 V 200 V 500 V

# TCN8X Series

High Capacitance Molded Stacked Capacitors

## DIMENSIONS in inches (mm)

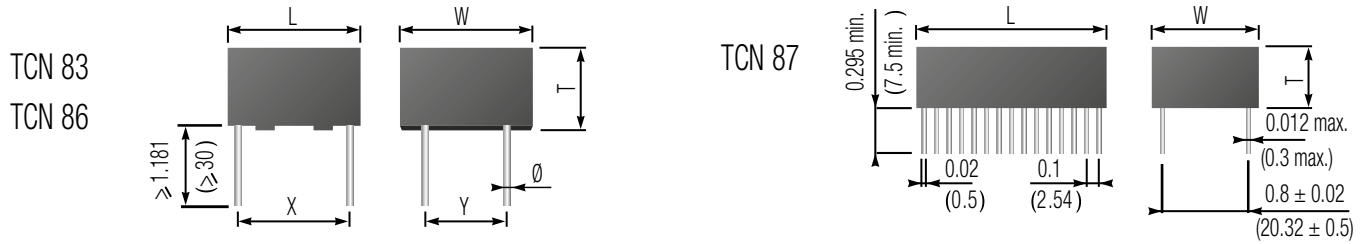

## STANDARD RATINGS

Series		TCN83	TCN86	TCN83	TCN86	TCN83	TCN86	TCN83	TCN86	TCN83	TCN86	TCN87	
Case		1	1	2	2	3	3	4	4	5	5	-	
Dimensions inches (mm)	L	±0.02 (±0.5)	0.787 (20)	0.787 (20)	0.787 (20)	0.787 (20)	0.787 (20)	0.787 (20)	0.787 (20)	0.787 (20)	0.787 (20)	1.673 (42.5)	
	W	±0.02 (±0.5)	0.748 (19)	0.787 (20)	0.748 (19)	0.787 (20)	0.748 (19)	0.787 (20)	0.748 (19)	0.787 (20)	0.748 (19)	0.906 (23)	
	X	±0.02 (±0.5)	0.701 (17.8)	0.600 (15.24)	0.701 (17.8)	0.600 (15.24)	0.701 (17.8)	0.600 (15.24)	0.701 (17.8)	0.600 (15.24)	0.701 (17.8)	0.600 (15.24)	-
	Y	±0.02 (±0.5)	0.400 (10.16)	0.500 (12.7)	0.400 (10.16)	0.500 (12.7)	0.400 (10.16)	0.500 (12.7)	0.400 (10.16)	0.500 (12.7)	0.400 (10.16)	0.500 (12.7)	-
	T		0.256 max (6.5 max)		0.315 max (8 max)		0.493 max (12.5 max)		0.788 max (20 max)		1.182 max (30 max)		0.492 ± 0.02 (12.5 ± 0.5)
	Ø ± 10%		0.039 (1)		0.039 (1)		0.039 (1)		0.039 (1)		0.039 (1)		-
Min. Capacitance value		0.47µF		0.56µF		1.8µF		3.3µF		5.6µF		2.2µF	
Rated voltage [U <sub>ric</sub> ]	63 V	Standard	12µF	12µF	18µF	18µF	27µF	27µF	68µF	68µF	100µF	100µF	100µF
		Extended	18µF	18µF	27µF	27µF	47µF	39µF	82µF	82µF	120µF	120µF	120µF
	100 V	Standard	4.7µF	4.7µF	6.8µF	6.8µF	15µF	15µF	27µF	27µF	39µF	39µF	56µF
		Extended	15µF	5.6µF	18µF	10µF	47µF	18µF	56µF	33µF	47µF	47µF	68µF
	200 V	Standard	1.5µF	1.5µF	2.2µF	2.2µF	3.9µF	3.9µF	8.2µF	8.2µF	15µF	15µF	15µF
		Extended	3.3µF	2.7µF	6.8µF	3.9µF	12µF	6.8µF	12µF	12µF	18µF	18µF	22µF
	400V	Standard	1.5µF	-	1.8µF	-	4.7µF	-	6.8µF	-	8.2µF	-	-
		Extended	0.82µF	0.82µF	1.5µF	1.5µF	2.7µF	2.7µF	4.7µF	4.7µF	6.8µF	6.8µF	8.2µF
	500 V	Standard	1.5µF	1.5µF	1.8µF	1.8µF	3.3µF	3.3µF	5.6µF	5.6µF	8.2µF	8.2µF	12µF
		Extended	1.5µF	1.5µF	1.8µF	1.8µF	3.3µF	3.3µF	5.6µF	5.6µF	8.2µF	8.2µF	12µF

Available capacitance values: E6, E12 (see page XX). Specific values upon request.  
The above table defines the standard products, other components may be built upon request.

## ELECTRICAL EQUIVALENT CIRCUITS

### TCN 83

Standard version to be used for usual applications.

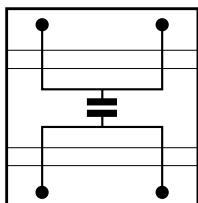

### TCN 86

Version featuring particular electrode geometry (crossed electrodes) allowing, compared to TCN 83, to achieve:

- lower series resistance RS
- higher permissible rms. current
- higher resonance frequency

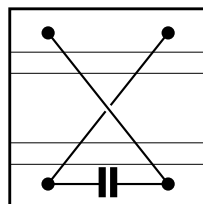

The total use of the the crossed four pole design allows operation at a higher operating frequency and reduces noise due to switching (lower self inductance) for a given capacitance value [see figures on the right].

### TCN 87

The use of DIL connections and the general «line shape» of the capacitor provide for:

- easy placement
- very high permissible rms currents
- suppression of switching noise

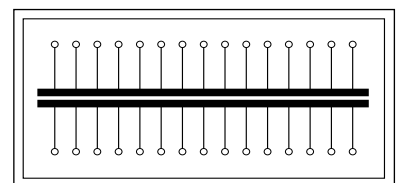

Figures on the right show the outstanding performance of these components in terms of impedance and series resistance.



# HIGH TEMPERATURE

**GENERAL INFORMATION** ..... 98

**CE / CN SERIES**

High Temperature Chips Capacitors ..... 100

**SCT SERIES**

High Temperature Stacked Capacitors ..... 102

**TCE / TCN MOLDED SERIES HT**

High Temperature Molded Capacitors ..... 107

**TCE / TCN SELF-PROTECTED SERIES**

High Temperature Self-Protected Capacitors ..... 109

**TCH SERIES**

High Temperature / High Voltage Capacitors ..... 111

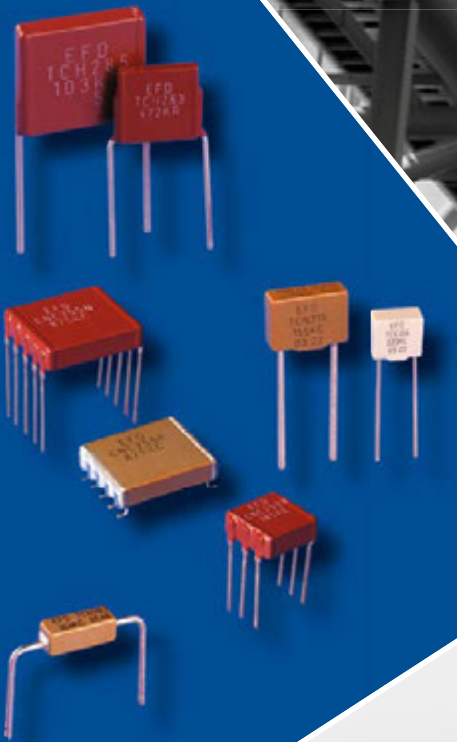

# General Information

High temperature capacitors are made of class 1 or class 2 ceramic dielectrics featuring special compositions based upon high purity oxides to reduce ionic conduction inherent to the presence of atoms such as sodium.

In addition, all quality controls carried out at intermediate and final production stages (lot acceptance test under  $U_{RC}$  and insulation resistance measurement at operating temperature) are the assurance of enhanced reliability.

High temperature capacitors include :

- chip class 1 (CEC 203 to CEC 233) and class 2 (CNC 203 to 233),
- encapsulated radial leads class 1 and 2 (TCE / TCN 201 to 204),
- encapsulated axial leads class 1 and 2 (TCE / TCN 252 to 254),
- selfprotected radial leads class 1 and 2 (TCE / TCN 212 to 216) and radial leads class 1 and 2 (TCE / TCN 263).

Mechanical stress is eliminated with replacement of epoxy by selfprotected ceramic. This also allows the increase of the capacitance ranges and improves the reliability.

- high voltage varnished capacitors (TCH 279 to 285)
- high capacitance value SCT Series.

They are highly recommended for operation at temperatures of up to 200°C. Capacitors specifically designed for higher operating temperatures (e.g. TCE / TCN 212 to 216 and TCE / TCN 263 to 266) are also available.

High temperature capacitors are made of class 1 or class 2 ceramic dielectrics featuring special compositions based upon high purity oxides to reduce ionic conduction inherent to the presence of atoms such as sodium.

In addition, all quality controls carried out at intermediate and final production stages (lot acceptance test under  $0.5 U_{RC}$  and insulation resistance measurement at 200°C) are the assurance of enhanced reliability.

## TYPICAL CURVES: CE / CN Series, TCE / TCN Series, TCH Series

NPO: TYPICAL CAPACITANCE VARIATION VERSUS TEMPERATURE

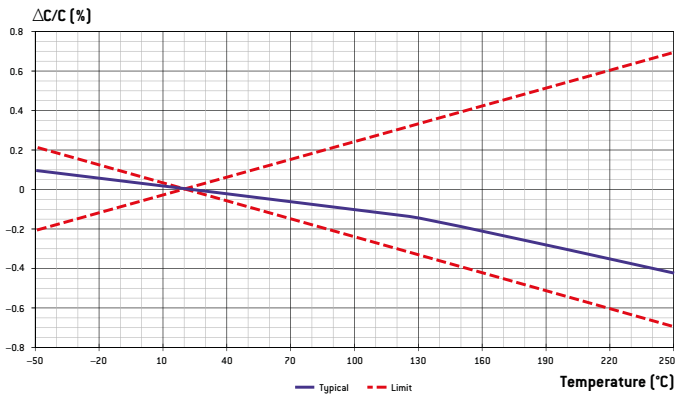

NPO: TYPICAL INSULATION RESISTANCE VERSUS TEMPERATURE

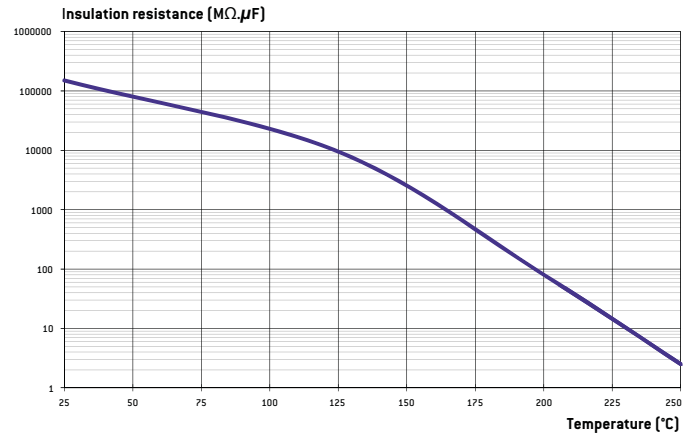

X7R: TYPICAL CAPACITANCE VARIATION VERSUS TEMPERATURE

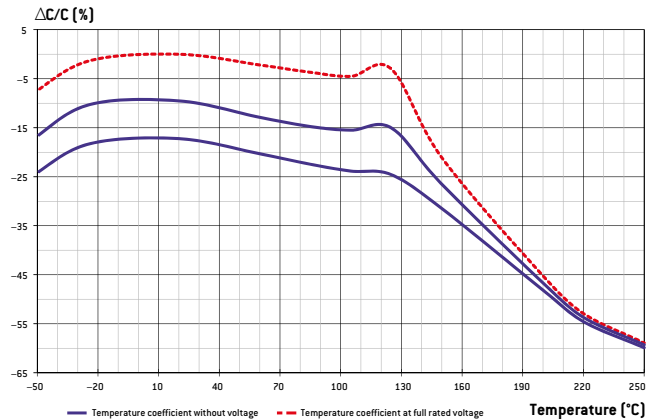

X7R: TYPICAL INSULATION RESISTANCE VERSUS TEMPERATURE



# General Information

## TYPICAL CURVES: SCT Series

ΔC/C VERSUS APPLIED VOLTAGE AND RATED VOLTAGE (U<sub>R</sub>)

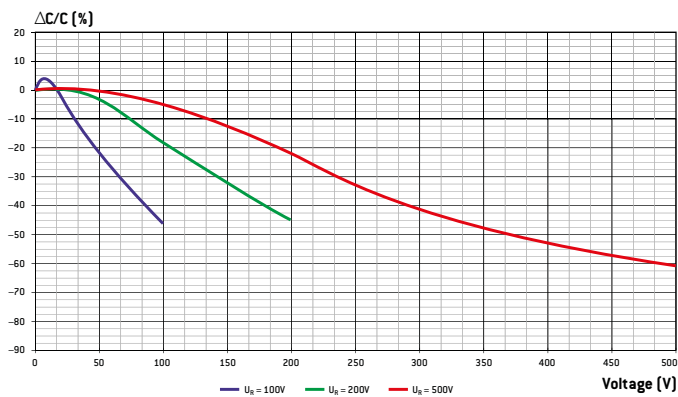

CAPACITANCE VERSUS TEMPERATURE

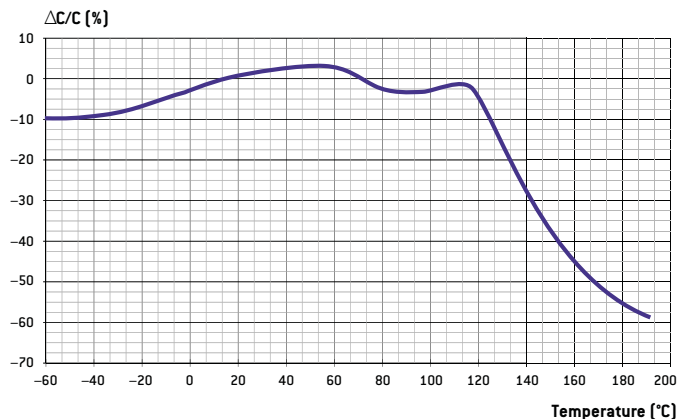

DIELECTRIC LOSSES VERSUS TEMPERATURE

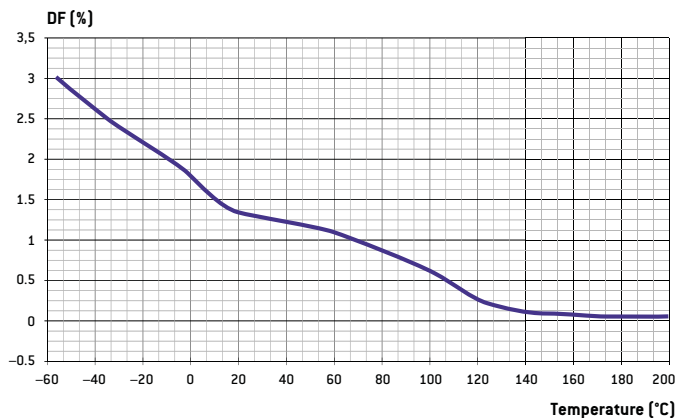

INSULATION RESISTANCE VERSUS TEMPERATURE

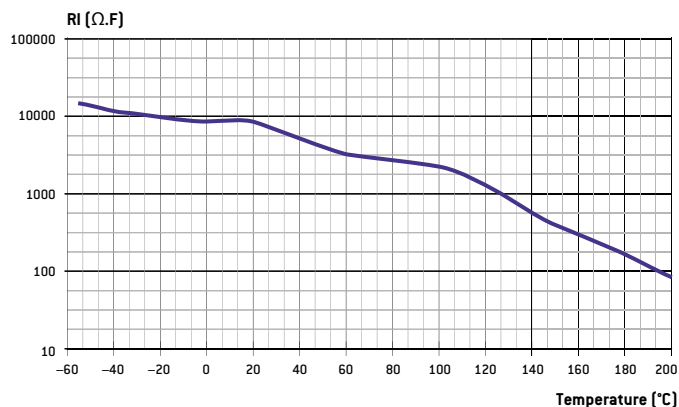

HIGH TEMPERATURE

# CE/CN Series

## High Temperature Chips Capacitors

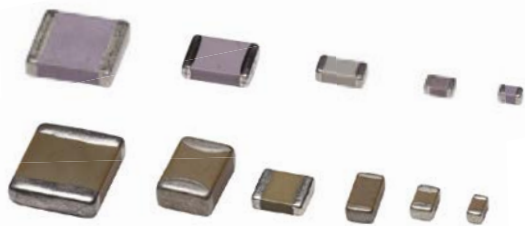

### FEATURES

- Multilayer Chips Ceramic Capacitors for operating temperature up to 250° C
- Size 0402 to 3040
- NPO and X7R dielectrics
- Capacitance range: 1pF to 8.2μF
- Voltage range at 20°C: 16 V<sub>DC</sub> to 100 V<sub>DC</sub>

### PHYSICAL CHARACTERISTICS

#### CONSTRUCTION

Bare chips capacitors for surface mounting with optional nickel barrier and tinning.

#### MARKING (clear or coded)

Capacitance value (not available on sizes 0402 and 0403).

### ELECTRICAL SPECIFICATIONS

Description	NPO	X7R
<b>Operating temperature</b>	-55°C to +250°C	-55°C to +250°C
<b>Rated voltage at 20° C</b>	16 V <sub>DC</sub> to 100 V <sub>DC</sub>	16 V <sub>DC</sub> to 500 V <sub>DC</sub>
<b>Dielectric withstanding voltage at 20° C</b>	2.5 U <sub>RC</sub> for U <sub>RC</sub> < 500 V <sub>DC</sub> 1.5 U <sub>RC</sub> for U <sub>RC</sub> = 500 V <sub>DC</sub>	2.5 U <sub>RC</sub> for U <sub>RC</sub> < 500 V <sub>DC</sub> 1.5 U <sub>RC</sub> for U <sub>RC</sub> = 500 V <sub>DC</sub>
<b>Capacitance</b>	at 1MHz for C ≤ 1,000pF at 1kHz for C > 1,000pF	at 1MHz for C ≤ 100pF at 1kHz for C > 100pF
<b>Dissipation factor at 20° C</b>	≤ 0.015 (150/C + 7)% at 1MHz for C ≤ 50pF ≤ 0.15% at 1MHz for 50pF < C ≤ 1,000pF ≤ 0.15% at 1kHz for C > 1,000pF	≤ 2.5% at 1MHz for C ≤ 100pF ≤ 2.5% at 1kHz for C > 100pF
<b>Dissipation factor at 200° C</b>	≤ 0.03 (150/C + 7)% at 1MHz for C ≤ 50pF ≤ 0.3% at 1MHz for 50pF < C ≤ 1,000pF ≤ 0.3% at 1kHz for C > 1,000pF	≤ 1.5% at 1MHz for C ≤ 100pF ≤ 1.5% at 1kHz for C > 100pF
<b>Dissipation factor at 220° C</b>	≤ 0.03 (150/C + 7)% at 1MHz for C ≤ 50pF ≤ 0.3% at 1MHz for 50pF < C ≤ 1,000pF ≤ 0.3% at 1kHz for C > 1,000pF	≤ 0.5% at 1MHz for C ≤ 100pF ≤ 0.5% at 1kHz for C > 100pF
<b>Dissipation factor at 250° C</b>	≤ 0.03 (150/C + 7)% at 1MHz for C ≤ 50pF ≤ 0.3% at 1MHz for 50pF < C ≤ 1,000pF ≤ 0.3% at 1kHz for C > 1,000pF	≤ 0.5% at 1MHz for C ≤ 100pF ≤ 0.5% at 1kHz for C > 100pF
<b>Insulation resistance at 20° C under U<sub>RC</sub></b>	≥ 100,000MΩ or ≥ 1,000MΩ.μF (whichever is less)	≥ 100,000MΩ or ≥ 1,000MΩ.μF (whichever is less)
<b>Insulation resistance at 200° C under U<sub>RC</sub></b>	≥ 1,000MΩ or ≥ 20MΩ.μF (whichever is less)	≥ 1,000MΩ or ≥ 10MΩ.μF (whichever is less)
<b>Insulation resistance at 220° C under U<sub>RC</sub></b>	≥ 800MΩ or ≥ 8MΩ.μF (whichever is less)	≥ 200MΩ or ≥ 4MΩ.μF (whichever is less)
<b>Insulation resistance at 250° C under U<sub>RC</sub></b>	≥ 200MΩ or ≥ 2MΩ.μF (whichever is less)	≥ 100MΩ or ≥ 1MΩ.μF (whichever is less)
<b>Ageing</b>	None	≤ 2.5% per decade hour

### HOW TO ORDER

CNC	2	11	C	W	M	47nF	10%	100 V	S8
CN	2X	0805							
CN	5X	0805							
Series	Exxelia size code	Terminations	RoHS compliant	Marking	Capacitance	Tolerance	Rated voltage at 20° C	Packaging	
<b>Operating temperature</b> Up to 200° C CE2 = NPO CN2 = X7R  Up to 220° C CE2X = NPO CN2X = X7R  Up to 250° C CE5X = NPO CN5X = X7R	19 = 0402 17 = 0403 14 = 0603 03 = 0805 08 = 1206 11 = 1210 20 = 1812 28 = 1825 30 = 2220 25 = 2225 33 = 3030 40 = 3040  For 2X and 5X series, use the standard size	W = RoHS compliant - Ag/Pd/Pt W Ag/Pd/Pt  For working temperature up to 200° C Up to size 1210 for X7R and 2220 for NPO E Ag + Ni + HMP EW Ag + Ni + electrolytic Sn C Ag + Ni + electrolytic Sn/Pb 95/5 CW Ag + Ni + electrolytic Sn G Ag + Ni + Au GW Ag + Ni + Au  For working temperature up to 180° C Up to size 3030 YC Ag + Polymer + Ni + Sn/Pb 95/5 YCW Ag + Polymer + Ni + Sn YG Ag + Polymer + Ni + Au YGW Ag + Polymer + Ni + Au	- = No RoHS compliant W = RoHS compliant	- = no marking M = Marking: capacitance value clear or coded (not available on sizes 0402 and 0403)	Capacitance value in clear	NPO: cap. value ≤ 12pF ±0.25pF cap. value ≤ 8.2pF ±0.5pF cap. value > 22pF ±1pF cap. value > 12pF ±2% cap. value > 8.2pF ±5% cap. value > 10% ±10% cap. value > 3.9pF ±20%  X7R: ±10% ±20%	16V 25 V 50 V 100 V	- = Exxelia packaging S8* = available for 0402 to 1210 sizes. S12* = available for 1812 to 2220 sizes. BA* = available for 0402 to 2220 sizes.  * not available with E, EW terminations See page 13	

DIMENSIONS in inches (mm)

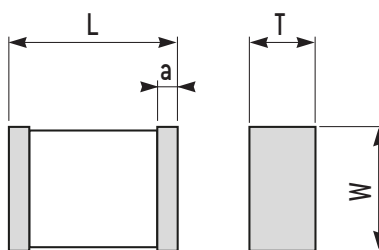

L, W, T, for tinned chips  
(option E, EW, H, or HW): +0.02" (+0,5mm)

STANDARD RATINGS

Standard size		0402		0403		0603		0805		1206		1210				
Excellia size code		19		17		14		03		08		11				
Dimensions inches (mm)	L	0.039 ± 0.004 (1 ± 0.1)		0.039 ± 0.004 (1 ± 0.1)		0.063 ± 0.006 (1.6 ± 0.15)		0.079 ± 0.012 (2 ± 0.3)		0.126 ± 0.01 (3.2 ± 0.25)		0.126 ± 0.016 (3.2 ± 0.4)				
	W	0.02 ± 0.004 (0.5 ± 0.1)		0.03 ± 0.004 (0.76 ± 0.1)		0.032 ± 0.006 (0.8 ± 0.15)		0.049 ± 0.008 (1.25 ± 0.2)		0.063 ± 0.006 (1.6 ± 0.15)		0.098 ± 0.012 (2.5 ± 0.3)				
	a	0.004 min (0.1) min		0.004 min (0.1) min		0.012 ± 0.008 (0.3 ± 0.2)		0.02 ± 0.012 (0.5 ± 0.3)		0.02 ± 0.012 (0.5 ± 0.3)		0.024 ± 0.016 (0.6 ± 0.4)				
	T max.	0.024 (0.6)		0.032 (0.8)		0.04 (1)		0.052 (1.3)		0.063 (1.6)		0.071 (1.8)				
Dielectric		NPO		X7R		NPO		X7R		NPO		X7R				
Min. Capa. value		1pF		10pF		1pF		10pF		1pF		180pF				
Rated voltage (U <sub>RC</sub> )	20°C 200°C 220°C 250°C															
	16V	8V	5V	3V	270pF	15nF	820pF	47nF	2.7nF	120nF	12nF	470nF	22nF	1.2μF	56nF	2.2μF
	25V	12V	8V	5V	180pF	5.6nF	470pF	18nF	1.8nF	56nF	6.8nF	220nF	15nF	680nF	39nF	1μF
	50V	25V	16V	10V	82pF	3.9nF	330pF	12nF	820pF	33nF	3.3nF	120nF	8.2nF	270nF	18nF	560nF
	100V	50V	25V	16V	39pF	1.2nF	120pF	3.3nF	330pF	12nF	1.5nF	39nF	3.9nF	120nF	8.2nF	220nF

Standard size		1812		1825		2220		2225		3030		3040				
Excellia size code		20		28		30		25		33		40				
Dimensions inches (mm)	L	0.177 ± 0.02 (4.5 ± 0.5)		0.177 ± 0.020 (4.5 ± 0.5)		0.224 ± 0.02 (5.7 ± 0.5)		0.224 ± 0.02 (5.7 ± 0.5)		0.299 ± 0.02 (7.6 ± 0.5)		0.299 ± 0.02 (7.6 ± 0.5)				
	W	0.126 ± 0.016 (3.2 ± 0.4)		0.250 ± 0.020 (6.35 ± 0.5)		0.197 ± 0.02 (5 ± 0.5)		0.250 ± 0.020 (6.35 ± 0.5)		0.299 ± 0.02 (7.6 ± 0.5)		0.4 ± 0.02 (10.16 ± 0.5)				
	a	0.024 ± 0.016 (0.6 ± 0.4)		0.024 ± 0.020 (0.6 ± 0.4)		0.024 ± 0.016 (0.6 ± 0.4)		0.024 ± 0.020 (0.6 ± 0.4)		0.024 ± 0.016 (0.6 ± 0.4)		0.024 ± 0.016 (0.6 ± 0.4)				
	T max.	0.071 (1.8)		0.071 (1.8)		0.071 (1.8)		0.079 (2)		0.079 (2)		0.079 (2)				
Dielectric		NPO		X7R		NPO		X7R		NPO		X7R				
Min. Capa. value		47pF		470pF		100pF		1nF		100pF		1.2nF				
Rated voltage (U <sub>RC</sub> )	20°C 200°C 220°C 250°C															
	16V	8V	5V	3V	100nF	4.7μF	150nF	2.7μF	180nF	10μF	180nF	4.7μF	330nF	6.8μF	470nF	8.2μF
	25V	12V	8V	5V	47nF	2.2μF	82nF	2.2μF	82nF	4.7μF	100nF	3.9μF	180nF	3.9μF	270nF	5.6μF
	50V	25V	16V	10V	27nF	1.2μF	56nF	1.5μF	56nF	2.7μF	68nF	2.2μF	120nF	2.7μF	150nF	3.9μF
	100V	50V	25V	16V	15nF	470nF	22nF	820nF	33nF	1μF	33nF	1.2μF	56nF	1.5μF	82nF	2.2μF

Available capacitance values:  
 NPO: E6, E12, E24, E48, E96 (see page 14). Specific values upon request.  
 X7R: E6, E12, E24 (see page 14). Specific values upon request.  
 The above table defines the standard products, other components may be built upon request.

HIGH TEMPERATURE

# SCT Series

## High Temperature Stacked Capacitors

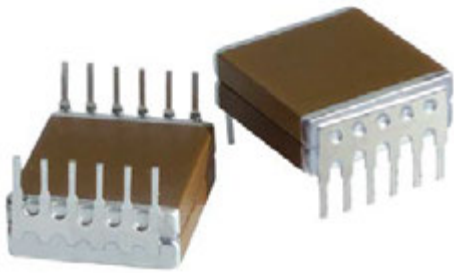

### FEATURES

- Multilayer stacked ceramic capacitors
- Dielectric type II
- Capacitance range: 47 nF to 390 μF
- Voltage range: 50 V<sub>DC</sub> to 500 V<sub>DC</sub>

### TERMINATIONS

- Ag 100% termination developed for high temperature up to 215°C. Less sensitive to thermal shocks and compatible with high melting point solder containing lead.
- DIL type J, L or N are available.

### MARKING

Size	Marking codes	Example
	«TA» logo	TA
All sizes	Cap code + Tolerance code	105M
	Rated voltage value	100 V

### PACKAGING

«Blister» boxes:

For all products, special «blister» boxes are used to optimize the protection of the parts during the carriage and the storage. Depending upon the termination (with or without connection) and the size, the number of the parts in each box is defined. Please, consult us for more details.

### ELECTRICAL SPECIFICATIONS

Description	«X» Series (type II)
CECC	2R1
EIA	X7R
Exxelia Temex Code	X
Operating temperature range	-55°C to +125°C
Storage temperature range	-55°C to +125°C
Maximum ΔC/°C over Temperature range without voltage applied	± 15%
Ageing	≤2.5% per decade hour
Dissipation Factor (DF)	≤ 2.5%
Voltage proof	U <sub>R</sub> ≤ 200 V: 2.5 x U <sub>R</sub> U <sub>R</sub> > 200 V: 2.0 x U <sub>R</sub>
Insulation Resistance (IR) at 25°C under U <sub>R</sub>	100GΩ or 1000Ω.F whichever is the less
Insulation Resistance (IR) at 125°C under U <sub>R</sub>	10GΩ or 100Ω.F whichever is the less
Measurement Conditions for C and DF at 20°C	≤ 100pF: 1MHz / 1Vrms (no bias) > 100pF: 1KHz / 1Vrms (no bias)
Capacitance versus applied Voltage and Temperature	See page 99

### HOW TO ORDER

201	SCT	01	X	105	K	R	-	-RoHS
Rated voltage	Series	Exxelia size code	Dielectric code	Capacitance	Tolerance	Termination	Coating	RoHS Compliant
500: 50 V 101: 100 V 201: 200 V 501: 500 V	SCT	00 01 02 04 05 06 07 10 12	X = X7R	1 <sup>st</sup> two digits represent significant figures; last digit specifies the number of zeros to follow. Examples: 104: 0.1μF 335: 3.3μF 156: 15μF 107: 10μF	K = ± 10% M = ± 20%	DN DIL N type DJ DIL J type DL DIL L type	- = uncoated and no marking U = uncoated and marked	Non-RoHS not available

## High Temperature Stacked Capacitors

### DIMENSIONS in inches (mm)

#### SC SERIES

Dual In Line DIL termination

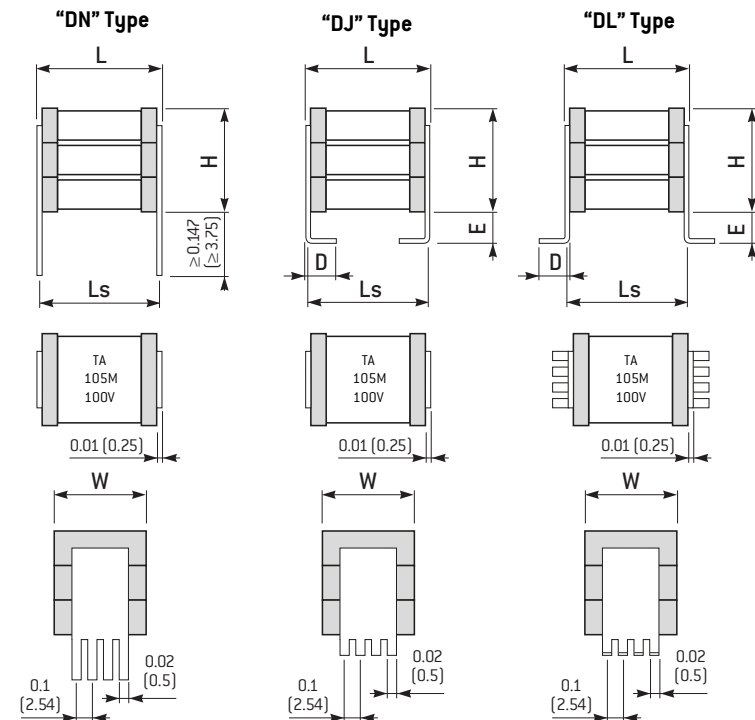

Note: the marking shown here is just given as an example

Size	L max.	W max.	LS ± 0.02* (± 0.5)*	E ± 0.012 (± 0.5)**	D ± 0.02 (± 0.5)	Number of leads per side	H max.
SCT00	0.300 (7.62)	0.276 (?)	0.250 (6.35)	0.071 (1.8)	0.079 (2)	3	Please, consult the tables of standard ratings
SCT01	0.402 (10.2)	0.378 (9.6)	0.300 (7.62)	0.059 (1.5)	0.098 (2.5)	3	
SCT02	0.469 (11.9)	0.449 (11.4)	0.400 (10.16)	0.059 (1.5)	0.098 (2.5)	4	
SCT04	0.650 (16.5)	0.552 (14)	0.539 (13.7)	0.059 (1.5)	0.098 (2.5)	5	
SCT05	0.729 (18.5)	0.670 (17)	0.700 (17.78)	0.059 (1.5)	0.098 (2.5)	6	
SCT06	0.701 (17.8)	0.851 (21.6)	0.600 (15.24)	0.059 (1.5)	0.098 (2.5)	7	
SCT07	0.894 (22.7)	0.654 (16.6)	0.800 (20.32)	0.059 (1.5)	0.098 (2.5)	6	
SCT10	0.520 (13.2)	1.083 (27.5)	0.453 (11.5)	0.083 (2.1)	0.102 (2.6)	10	
SCT12	0.945 (24)	1.598 (40.6)	0.800 (20.32)	0.098 (2.5)	0.098 (2.5)	14	

\* Except for the SCT07, tolerance = ± 0.032 in (± 0.8mm).

\*\* For the SCT12, tolerance = ± 0.012 in (± 0.3mm).

### DERATING RULES

The given voltages in the below capacitance range are the nominal voltages at 125°C.

For higher operating temperatures, the derating rules to be applied on the voltage versus temperature are defined as per the following table :

125°C	200°C	215°C
500V	200V	100V
200V	100V	50V
100V	50V	25V
50V	25V	16V

### STANDARD RATINGS

Exxelia size code	2225				3033				3740				5550				Cap. code
	SCT00				SCT01				SCT02				SCT04				
	U <sub>R</sub>	50 V	100 V	200 V	500 V	50 V	100 V	200 V	500 V	50 V	100 V	200 V	500 V	50 V	100 V	200 V	
47 nF				0.118 (3)				0.083 (2.1)									473
56				0.118 (3)				0.083 (2.1)									563
68				0.118 (3)				0.083 (2.1)									683
82				0.118 (3)				0.083 (2.1)									823
100			0.039 (1.8)	0.118 (3)			0.083 (2.1)	0.098 (2.5)					0.118 (3)				104
120			0.039 (1.8)	0.118 (3)			0.083 (2.1)	0.098 (2.5)					0.118 (3)				124
150			0.079 (2)	0.252 (6.4)			0.083 (2.1)	0.098 (2.5)					0.118 (3)				154
180	0.039 (1.8)	0.039 (1.8)	0.079 (2)	0.252 (6.4)	0.083 (2.1)	0.083 (2.1)	0.083 (2.1)	0.126 (3.2)			0.083 (2.1)	0.118 (3)					184
220	0.039 (1.8)	0.039 (1.8)	0.098 (2.5)	0.252 (6.4)	0.083 (2.1)	0.083 (2.1)	0.083 (2.1)	0.126 (3.2)			0.083 (2.1)	0.118 (3)					224
270	0.039 (1.8)	0.039 (1.8)	0.098 (2.5)	0.378 (9.6)	0.083 (2.1)	0.083 (2.1)	0.083 (2.1)	0.138 (3.5)			0.083 (2.1)	0.118 (3)				0.098 (2.5)	274
330	0.039 (1.8)	0.039 (1.8)	0.118 (3)	0.378 (9.6)	0.083 (2.1)	0.083 (2.1)	0.083 (2.1)	0.241 (6.1)	0.083 (2.1)	0.083 (2.1)	0.083 (2.1)	0.130 (3.3)				0.098 (2.5)	334
390	0.039 (1.8)	0.039 (1.8)	0.118 (3)	0.504 (12.8)	0.083 (2.1)	0.083 (2.1)	0.083 (2.1)	0.241 (6.1)	0.083 (2.1)	0.083 (2.1)	0.083 (2.1)	0.138 (3.5)				0.098 (2.5)	394
470	0.039 (1.8)	0.039 (1.8)	0.213 (5.4)	0.504 (12.8)	0.083 (2.1)	0.083 (2.1)	0.083 (2.1)	0.272 (6.9)	0.083 (2.1)	0.083 (2.1)	0.083 (2.1)	0.157 (4)				0.118 (3)	474
560	0.079 (2)	0.079 (2)	0.232 (5.9)	0.551 (14)	0.083 (2.1)	0.083 (2.1)	0.098 (2.5)	0.414 (10.5)	0.083 (2.1)	0.083 (2.1)	0.083 (2.1)	0.169 (4.3)				0.118 (3)	564
680	0.079 (2)	0.079 (2)	0.252 (6.4)	0.630 (16)	0.083 (2.1)	0.083 (2.1)	0.118 (3)	0.414 (10.5)	0.083 (2.1)	0.083 (2.1)	0.098 (2.5)	0.276 (7)				0.118 (3)	684
820	0.079 (2)	0.079 (2)	0.319 (8.1)	0.709 (18)	0.083 (2.1)	0.083 (2.1)	0.138 (3.5)	0.548 (13.9)	0.083 (2.1)	0.083 (2.1)	0.098 (2.5)	0.390 (9.9)			0.118 (3)	0.138 (3.5)	824
1 μF	0.087 (2.2)	0.087 (2.2)	0.378 (9.6)		0.098 (2.5)	0.098 (2.5)	0.174 (4.4)	0.583 (14.8)	0.083 (2.1)	0.083 (2.1)	0.118 (3)	0.406 (10.3)			0.118 (3)	0.165 (4.2)	105
1.2	0.098 (2.5)	0.098 (2.5)	0.504 (12.8)		0.098 (2.5)	0.098 (2.5)	0.213 (5.4)	0.669 (17.6)	0.083 (2.1)	0.083 (2.1)	0.138 (3.5)	0.552 (14)			0.118 (3)	0.252 (6.4)	125
1.5	0.118 (3)	0.118 (3)	0.551 (14)		0.110 (2.8)	0.110 (2.8)	0.260 (6.6)		0.083 (2.1)	0.083 (2.1)	0.157 (4)	0.630 (16)			0.118 (3)	0.378 (9.6)	155
1.8	0.173 (4.4)	0.173 (4.4)	0.630 (16.4)		0.110 (2.8)	0.110 (2.8)	0.347 (8.8)		0.098 (2.5)	0.098 (2.5)	0.233 (5.9)	0.709 (18)	0.098 (2.5)	0.098 (2.5)	0.118 (3)	0.378 (9.6)	185
2.2	0.197 (5.1)	0.197 (5.1)	0.630 (16.4)		0.110 (2.8)	0.110 (2.8)	0.426 (10.8)		0.098 (2.5)	0.098 (2.5)	0.252 (6.4)	0.709 (18)	0.098 (2.5)	0.098 (2.5)	0.118 (3)	0.378 (9.6)	225
2.7	0.232 (5.9)	0.232 (5.9)			0.130 (3.3)	0.130 (3.3)	0.552 (14)		0.110 (2.8)	0.110 (2.8)	0.252 (6.4)		0.098 (2.5)	0.098 (2.5)	0.138 (3.5)	0.504 (12.8)	275
3.3	0.296 (7.5)	0.296 (7.5)			0.150 (3.8)	0.150 (3.8)	0.591 (15)		0.110 (2.8)	0.110 (2.8)	0.378 (9.6)		0.098 (2.5)	0.098 (2.5)	0.157 (4)	0.583 (14.8)	335
3.9	0.339 (8.6)	0.339 (8.6)			0.237 (6)	0.244 (6.2)			0.130 (3.3)	0.130 (3.3)	0.378 (9.6)		0.098 (2.5)	0.098 (2.5)	0.252 (6.4)	0.662 (16.8)	395
4.7	0.378 (9.6)	0.378 (9.6)			0.237 (6)	0.252 (6.4)			0.138 (3.5)	0.138 (3.5)	0.504 (12.8)		0.118 (3)	0.118 (3)	0.378 (9.6)		475
5.6	0.484 (12.3)	0.484 (12.3)			0.276 (7)	0.283 (7.2)			0.142 (3.6)	0.142 (3.6)	0.630 (16)		0.118 (3)	0.118 (3)	0.378 (9.6)		565
6.8	0.504 (12.8)	0.504 (12.8)			0.315 (8)	0.323 (8.2)			0.185 (4.7)	0.185 (4.7)	0.709 (18)		0.118 (3)	0.118 (3)	0.434 (11)		685
8.2	0.630 (16)	0.630 (16)			0.434 (11)	0.441 (11.2)			0.284 (7.2)	0.354 (9)			0.138 (3.5)	0.138 (3.5)	0.438 (11.1)		825
10					0.473 (12)	0.480 (12.2)			0.292 (7.4)	0.354 (9)			0.150 (3.8)	0.150 (3.8)	0.497 (12.6)		106
12					0.552 (14)	0.559 (14.4)			0.414 (10.5)	0.472 (12)			0.252 (6.4)	0.252 (6.4)	0.630 (16)		126
15									0.438 (11.1)	0.492 (12.5)			0.284 (7.2)	0.319 (8.1)			156
18									0.583 (14.8)	0.591 (15)			0.304 (7.7)	0.394 (10.8)			186
22									0.598 (15.2)	0.598 (15.2)			0.315 (8)	0.504 (12.8)			226
27													0.461 (11.7)	0.504 (12.8)			276
33													0.473 (12)	0.583 (14.8)			336
39													0.630 (16)	0.662 (16.8)			396

\* Consult us - The height Hmax in inches (in mm) for the SCT Series is indicated in the cells.



# High Temperature Stacked Capacitors

# SCT Series

## STANDARD RATINGS

Exxelia size code	6560				6080 / 8060				45107				45214				Cap. code
	SCT05				SCT06 / SCT07				SCT10				SCT11				
	U <sub>R</sub>	50 V	100 V	200 V	500 V	50 V	100 V	200 V	500 V	50 V	100 V	200 V	500 V	50 V	100 V	200 V	
270 nF				0.098 (2.5)													274
330				0.098 (2.5)													334
390				0.098 (2.5)													394
470				0.098 (2.5)				0.118 (3)									474
560			0.098 (2.5)	0.098 (2.5)				0.118 (3)									564
680			0.098 (2.5)	0.098 (2.5)				0.118 (3)				0.138 (3.5)					684
820			0.098 (2.5)	0.118 (3)				0.118 (3)			0.118 (3)	0.138 (3.5)					824
1 μF	0.098 (2.5)	0.098 (2.5)	0.098 (2.5)	0.118 (3)				0.118 (3)	0.118 (3)	0.118 (3)	0.118 (3)	0.150 (3.8)					105
1.2	0.098 (2.5)	0.098 (2.5)	0.098 (2.5)	0.138 (3.5)				0.138 (3.5)	0.118 (3)	0.118 (3)	0.118 (3)	0.150 (3.8)					125
1.5	0.098 (2.5)	0.098 (2.5)	0.098 (2.5)	0.157 (4)			0.118 (3)	0.157 (4)	0.118 (3)	0.118 (3)	0.118 (3)	0.252 (6.4)					155
1.8	0.098 (2.5)	0.098 (2.5)	0.098 (2.5)	0.177 (4.5)			0.118 (3)	0.177 (4.5)	0.118 (3)	0.118 (3)	0.118 (3)	0.252 (6.4)					185
2.2	0.098 (2.5)	0.098 (2.5)	0.098 (2.5)	0.272 (6.9)			0.118 (3)	0.272 (6.9)	0.118 (3)	0.118 (3)	0.138 (3.5)	0.252 (6.4)					225
2.7	0.098 (2.5)	0.098 (2.5)	0.118 (3)	0.312 (7.9)			0.118 (3)	0.378 (9.6)	0.118 (3)	0.118 (3)	0.150 (3.8)	0.292 (7.4)				*	275
3.3	0.098 (2.5)	0.098 (2.5)	0.118 (3)	0.331 (8.4)			0.118 (3)	0.398 (10.1)	0.118 (3)	0.118 (3)	0.157 (4)	0.378 (9.6)				*	335
3.9	0.098 (2.5)	0.098 (2.5)	0.138 (3.5)	0.438 (11.1)	0.118 (3)	0.118 (3)	0.138 (3.5)	0.504 (12.8)	0.118 (3)	0.118 (3)	0.213 (5.4)	0.504 (12.8)				*	395
4.7	0.098 (2.5)	0.098 (2.5)	0.157 (4)	0.497 (12.6)	0.118 (3)	0.118 (3)	0.157 (4)	0.583 (14.8)	0.118 (3)	0.118 (3)	0.233 (5.9)	0.583 (14.8)				*	475
5.6	0.098 (2.5)	0.098 (2.5)	0.233 (5.9)	0.662 (16.8)	0.118 (3)	0.118 (3)	0.252 (6.4)	0.583 (14.8)	0.118 (3)	0.118 (3)	0.252 (6.4)	0.583 (14.8)				*	565
6.8	0.098 (2.5)	0.098 (2.5)	0.252 (6.4)	0.819 (20.8)	0.118 (3)	0.118 (3)	0.252 (6.4)	0.661 (16.8)	0.118 (3)	0.118 (3)	0.319 (8.1)	0.662 (16.8)				*	685
8.2	0.118 (3)	0.118 (3)	0.359 (9.1)		0.118 (3)	0.118 (3)	0.378 (9.6)	0.740 (18.8)	0.118 (3)	0.118 (3)	0.378 (9.6)				*	*	825
10	0.118 (3)	0.118 (3)	0.378 (9.6)		0.138 (3.5)	0.138 (3.5)	0.378 (9.6)		0.138 (3.5)	0.138 (3.5)	0.378 (9.6)				*	*	106
12	0.138 (3.5)	0.138 (3.5)	0.504 (12.8)		0.138 (3.5)	0.138 (3.5)	0.504 (12.8)		0.138 (3.5)	0.138 (3.5)	0.504 (12.8)			*	*	*	126
15	0.157 (4)	0.157 (4)	0.583 (14.8)		0.138 (3.5)	0.138 (3.5)	0.504 (12.8)		0.252 (6.4)	0.252 (6.4)	0.504 (12.8)			*	*		156
18	0.252 (6.4)	0.252 (6.4)			0.146 (3.7)	0.146 (3.7)	0.630 (16)		0.252 (6.4)	0.252 (6.4)	0.661 (16.8)			*	*		186
22	0.252 (6.4)	0.252 (6.4)			0.252 (6.4)	0.291 (7.4)	0.740 (18.8)		0.378 (9.6)	0.378 (9.6)				*	*		226
27	0.312 (7.9)	0.378 (9.6)			0.252 (6.4)	0.323 (8.2)	0.740 (18.8)		0.378 (9.6)	0.378 (9.6)				*	*	*	276
33	0.331 (8.4)	0.378 (9.6)			0.280 (7.1)	0.413 (10.5)			0.504 (12.8)	0.504 (12.8)				*	*	*	336
39	0.457 (11.6)	0.504 (12.8)			0.378 (9.6)	0.441 (11.2)			0.504 (12.8)	0.504 (12.8)				*	*		396
47	0.497 (12.6)	0.504 (12.8)			0.378 (9.6)	0.465 (11.8)			0.591 (15)	0.591 (15)				*	*		476
56	0.662 (16.8)	0.669 (17)			0.457 (11.6)	0.472 (12)			0.591 (15)	0.591 (15)				*	*		566
68					0.583 (14.8)	0.591 (15)								*	*		686
82														*			826
100														*			107
120														*			127

\* Consult us - The height Hmax in inches (in mm) for the SCT Series is indicated in the cells.

HIGH TEMPERATURE

# SCT Series

## High Temperature Stacked Capacitors

### STANDARD RATINGS

Exxelia size code	80150				125205				Cap. code
	SCT12				SCT18				
	50 V	100 V	200 V	500 V	50 V	100 V	200 V	500 V	
680 nF									684
820									824
1 μF									105
1.2									125
1.5									155
1.8									185
2.2									225
2.7				0.157 (4)					275
3.3				0.157 (4)					335
3.9				0.157 (4)					395
4.7				0.157 (4)					475
5.6				0.315 (8)					565
6.8				0.315 (8)					685
8.2			0.157 (4)	0.315 (8)				*	825
10			0.157 (4)	0.315 (8)				*	106
12			0.315 (8)	0.472 (12)				*	126
15			0.315 (8)	0.472 (12)				*	156
18		*	0.315 (8)	0.630 (16)				*	186
22		*	0.315 (8)	*			*	*	226
27		*	0.472 (12)	*			*	*	276
33		0.157 (4)	0.472 (12)	*			*	*	336
39	0.157 (4)	0.157 (4)	0.630 (16)			*	*	*	396
47	0.157 (4)	0.315 (8)	*			*	*	*	476
56	0.315 (8)	0.315 (8)	*			*	*	*	566
68	0.315 (8)	0.315 (8)				*	*		686
82	0.315 (8)	0.315 (8)			*	*	*		826
100	0.315 (8)	0.472 (12)			*	*	*		107
120	0.472 (12)	0.472 (12)			*	*			127
150	0.472 (12)	0.630 (16)			*	*			157
180	0.630 (16)				*	*			187
220					*	*			227
270					*				277
330					*				337
390					*				397

\* Consult us - The height Hmax in inches (in mm) for the SCT Series is indicated in the cells.

# High Temperature Molded Capacitors

# TCE / TCN Molded Series HT

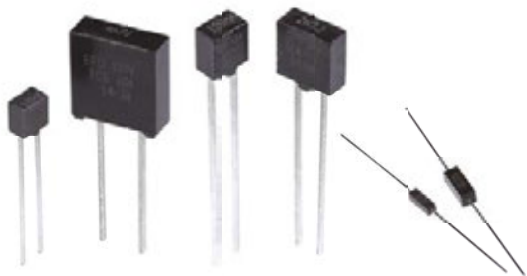

## FEATURES

- Multilayer chips ceramic capacitors for operating temperature up to 220°C
- NPO and X7R dielectrics
- Capacitance range: 1pF to 10µF
- Voltage range at 20°C: 16 V<sub>DC</sub> to 100 V<sub>DC</sub>

## PHYSICAL CHARACTERISTICS

### CONSTRUCTION

Epoxy molded radial or axial leaded chips capacitors for through-hole circuits.

### MARKING (clear or coded)

Series, capacitance value, tolerance, voltage, date code.

## ELECTRICAL SPECIFICATIONS

Description	NPO	X7R
<b>Operating temperature</b>	-55°C to +220°C	-55°C to +220°C
<b>Rated voltage at 20° C</b>	16 V <sub>DC</sub> to 100 V <sub>DC</sub>	16 V <sub>DC</sub> to 500 V <sub>DC</sub>
<b>Dielectric withstanding voltage at 20° C</b>	2.5 U <sub>RC</sub> for U <sub>RC</sub> < 500 V <sub>DC</sub> 1.5 U <sub>RC</sub> for U <sub>RC</sub> = 500 V <sub>DC</sub>	2.5 U <sub>RC</sub> for U <sub>RC</sub> < 500 V <sub>DC</sub> 1.5 U <sub>RC</sub> for U <sub>RC</sub> = 500 V <sub>DC</sub>
<b>Capacitance</b>	at 1MHz for C ≤ 1,000pF at 1kHz for C > 1,000pF	at 1MHz for C ≤ 100pF at 1kHz for C > 100pF
<b>Dissipation factor at 20° C</b>	≤ 0.015 (150/C + 7)% at 1MHz for C ≤ 50pF ≤ 0.15% at 1MHz for 50pF < C ≤ 1,000pF ≤ 0.15% at 1kHz for C > 1,000pF	≤ 2.5% at 1MHz for C ≤ 100pF ≤ 2.5% at 1kHz for C > 100pF
<b>Dissipation factor at 200° C</b>	≤ 0.03 (150/C + 7)% at 1MHz for C ≤ 50pF ≤ 0.3% at 1MHz for 50pF < C ≤ 1,000pF ≤ 0.3% at 1kHz for C > 1,000pF	≤ 1.5% at 1MHz for C ≤ 100pF ≤ 1.5% at 1kHz for C > 100pF
<b>Dissipation factor at 220° C</b>	≤ 0.03 (150/C + 7)% at 1MHz for C ≤ 50pF ≤ 0.3% at 1MHz for 50pF < C ≤ 1,000pF ≤ 0.3% at 1kHz for C > 1,000pF	≤ 0.5% at 1MHz for C ≤ 100pF ≤ 0.5% at 1kHz for C > 100pF
<b>Insulation resistance at 20° C under U<sub>RC</sub></b>	≥ 50,000MΩ or ≥ 1,000MΩ.µF (whichever is less)	≥ 20,000MΩ or ≥ 500MΩ.µF (whichever is less)
<b>Insulation resistance at 200° C under U<sub>RC</sub></b>	≥ 1,000MΩ or ≥ 20MΩ.µF (whichever is less)	≥ 200MΩ or ≥ 5MΩ.µF (whichever is less)
<b>Insulation resistance at 220° C under U<sub>RC</sub></b>	≥ 200MΩ or ≥ 5MΩ.µF (whichever is less)	≥ 100MΩ or ≥ 2MΩ.µF (whichever is less)
<b>Ageing</b>	None	≤ 2.5% per decade hour

## HOW TO ORDER

Series	Exxelia size code	Terminations	RoHS compliant	Capacitance	Tolerance	Rated voltage at 20° C	
TCE 2	01	-	W	12nF	10%	16 V	
TCE 2X	01	-	W	12nF	10%	16 V	
<b>Operating temperature</b>	<b>01</b> 02 03 04 51 52 53 54 55 56	- = Tinned copper leads  <u>Available on sizes 01, 02, 03, 04:</u> D = Tinned nickel leads	- = No RoHS  W = RoHS compliant	Capacitance value in clear	<b>NPO:</b> cap. value ≤ 12pF <b>± 0.25pF</b> cap. value ≤ 8.2pF <b>± 0.5pF</b> <b>± 1pF</b> cap. value > 22pF <b>± 1%</b> cap. value > 12pF <b>± 2%</b> cap. value > 8.2pF <b>± 5%</b> <b>± 10%</b> cap. value > 3.9pF <b>± 20%</b>	<b>X7R:</b> <b>± 10%</b> <b>± 20%</b>	<b>16V</b> <b>25 V</b> <b>50 V</b> <b>100 V</b>

# TCE / TCN Molded Series HT

High Temperature Molded Capacitors

## DIMENSIONS in inches (mm)

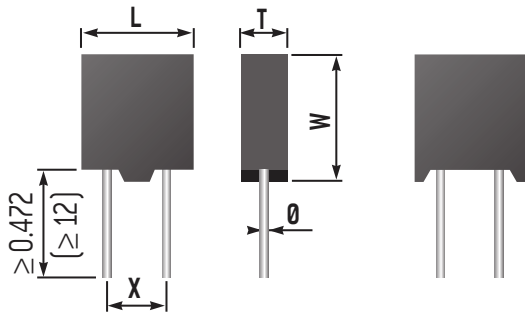

TCE/TCN 201, 202, 203, 204

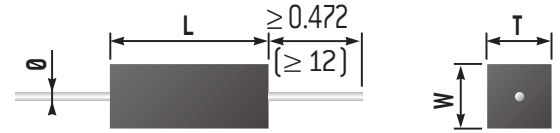

TCE/TCN 251, 252, 253, 254

## STANDARD RATINGS

Exxelia size code				01		02		03		04		52		53		54	
Dimensions inches (mm)	L ± 0.02 (± 0.5)			0.122 (3.1)	0.197 (5)	0.295 (7.5)	0.394 (10)	0.217 (5.5)	0.295 (7.5)	0.394 (10)	0.217 (5.5)	0.295 (7.5)	0.394 (10)				
	W max.			0.178 (4.5)	0.237 (6)	0.335 (8.5)	0.434 (11)	0.099 (2.5)	0.099 (2.5)	0.099 (2.5)	0.099 (2.5)	0.099 (2.5)	0.154 (3.9)				
	T ± 0.008 (± 0.2)			0.098 (2.5)	0.098 (2.5)	0.098 (2.5)	0.138 (3.5)	0.098 (2.5)	0.098 (2.5)	0.098 (2.5)	0.098 (2.5)	0.098 (2.5)	0.154 (3.9)				
	X ± 0.008 (± 0.2)			0.1 (2.54)	0.1 (2.54)	0.2 (5.08)	0.2 (5.08)	-	-	-	-	-	-				
	Ø ± 10%			0.024 (0.6)	0.024 (0.6)	0.024 (0.6)	0.031 (0.8)	0.024 (0.6)	0.024 (0.6)	0.024 (0.6)	0.024 (0.6)	0.024 (0.6)	0.024 (0.6)				
Dielectric				NPO	X7R	NPO	X7R	NPO	X7R	NPO	X7R	NPO	X7R	NPO	X7R	NPO	X7R
Min. capacitance value				1pF	10pF	10pF	180pF	100pF	1.2nF	390pF	4.7nF	1pF	10pF	1pF	100pF	10pF	180pF
Rated voltage (U <sub>rec</sub> )	20°C	200°C	220°C														
	16V	8V	5V	12nF	470nF	56nF	2.2µF	180nF	10µF	330nF	10µF	12nF	470nF	22nF	1.2µF	56nF	2.2µF
	25V	12V	8V	6.8nF	220nF	39nF	1µF	82nF	4.7µF	180nF	4.7µF	6.8nF	220nF	15nF	680nF	39nF	1µF
	50V	25V	16V	3.3nF	120nF	18nF	560nF	56nF	2.7µF	120nF	2.7µF	3.3nF	120nF	8.2nF	270nF	18nF	560nF
	100V	50V	25V	1.5nF	39nF	8.2nF	220nF	33nF	1µF	56nF	1.5µF	1.5nF	39nF	3.9nF	120nF	8.2nF	220nF

Available capacitance values:

NPO: E6, E12, E24 (see page 14). Specific values upon request.

X7R: E6, E12 (see page 14). Specific values upon request.

The above table defines the standard products, other components may be built upon request.

# High Temperature Self-Protected Capacitors

# TCE / TCN Self-Protected Series

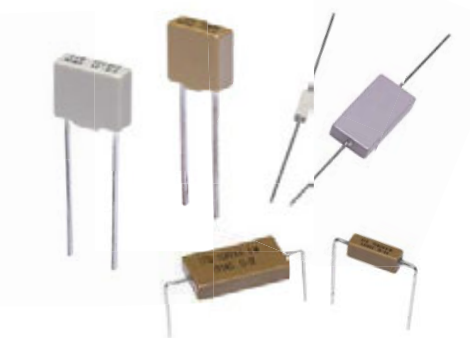

## FEATURES

- Multilayer Chips Ceramic Capacitors for operating temperature up to 250° C
- NPO and X7R dielectrics
- Capacitance range: 10pF to 3.3µF
- Voltage range at 20°C: 25 V<sub>DC</sub> to 500 V<sub>DC</sub>

## PHYSICAL CHARACTERISTICS

### CONSTRUCTION

Selfprotected radial or axial leaded chips capacitors for through-hole circuits. Mechanical stress is eliminated by replacement of epoxy by selfprotected ceramic.

### MARKING (clear or coded)

Series, capacitance value, tolerance, voltage, date code.

## ELECTRICAL SPECIFICATIONS

Description	NPO	X7R
<b>Operating temperature</b>	-55°C to +250°C	-55°C to +250°C
<b>Rated voltage at 20° C</b>	25 V <sub>DC</sub> to 500 V <sub>DC</sub>	25 V <sub>DC</sub> to 200 V <sub>DC</sub>
<b>Dielectric withstanding voltage at 20° C</b>	2.5 U <sub>RC</sub>	2.5 U <sub>RC</sub>
<b>Capacitance</b>	at 1MHz for C ≤ 1,000pF at 1kHz for C > 1,000pF	at 1MHz for C ≤ 100pF at 1kHz for C > 100pF
<b>Dissipation factor at 20° C</b>	≤ 0.015 (150/C + 7)% at 1MHz for C ≤ 50pF ≤ 0.15% at 1MHz for 50pF < C ≤ 1,000pF ≤ 0.15% at 1kHz for C > 1,000pF	≤ 2.5% at 1MHz for C ≤ 100pF ≤ 2.5% at 1kHz for C > 100pF
<b>Dissipation factor at 200° C</b>	≤ 0.03 (150/C + 7)% at 1MHz for C ≤ 50pF ≤ 0.3% at 1MHz for 50pF < C ≤ 1,000pF ≤ 0.3% at 1kHz for C > 1,000pF	≤ 1.5% at 1MHz for C ≤ 100pF ≤ 1.5% at 1kHz for C > 100pF
<b>Dissipation factor at 220° C</b>	≤ 0.03 (150/C + 7)% at 1MHz for C ≤ 50pF ≤ 0.3% at 1MHz for 50pF < C ≤ 1,000pF ≤ 0.3% at 1kHz for C > 1,000pF	≤ 0.5% at 1MHz for C ≤ 100pF ≤ 0.5% at 1kHz for C > 100pF
<b>Dissipation factor at 250° C</b>	≤ 0.03 (150/C + 7)% at 1MHz for C ≤ 50pF ≤ 0.3% at 1MHz for 50pF < C ≤ 1,000pF ≤ 0.3% at 1kHz for C > 1,000pF	≤ 0.5% at 1MHz for C ≤ 100pF ≤ 0.5% at 1kHz for C > 100pF
<b>Insulation resistance at 20° C under U<sub>RC</sub></b>	≥ 100,000MΩ or ≥ 1,000MΩ·µF (whichever is less)	≥ 100,000MΩ or ≥ 1,000MΩ·µF (whichever is less)
<b>Insulation resistance at 200° C under U<sub>RC</sub></b>	≥ 1,000MΩ or ≥ 20MΩ·µF (whichever is less)	≥ 1,000MΩ or ≥ 10MΩ·µF (whichever is less)
<b>Insulation resistance at 220° C under U<sub>RC</sub></b>	≥ 800MΩ or ≥ 8MΩ·µF (whichever is less)	≥ 200MΩ or ≥ 4MΩ·µF (whichever is less)
<b>Insulation resistance at 250° C under U<sub>RC</sub></b>	≥ 200MΩ or ≥ 5MΩ·µF (whichever is less)	≥ 100MΩ or ≥ 2MΩ·µF (whichever is less)
<b>Ageing</b>	None	≤ 2.5% per decade hour

## HOW TO ORDER

Series	Exxelia size code	Leads spacing code	RoHS compliant	Capacitance	Tolerance	Rated voltage at 20° C
TCN2	64	2	W	180pF	10%	100 V
TCN2X	64					
TCN5X	64					
<b>Operating temperature</b>	<b>12</b>	<b>Available on sizes 62, 63, 64, 65, 66:</b>	<b>- = No RoHS</b>	<b>Capacitance value in clear</b>	<b>NPO:</b> cap. value ≤ 12pF <b>± 0.25pF</b> cap. value ≤ 8.2pF <b>± 0.5pF</b> <b>± 1pF</b> cap. value > 22pF <b>± 1%</b> cap. value > 12pF <b>± 2%</b> cap. value > 8.2pF <b>± 5%</b> <b>± 10%</b> cap. value > 3.9pF <b>± 20%</b>	<b>25 V</b> <b>50 V</b> <b>100 V</b> <b>500 V</b>
<b>Up to 200° C</b> TCE2 = NPO TCN2 = X7R	<b>13</b> <b>14</b> <b>15</b> <b>16</b>	<b>-</b> <b>2</b> <b>3</b>	<b>Available on sizes 62, 63, 64, 65, 66:</b> <b>W = RoHS compliant</b>			
<b>Up to 220° C</b> TCE2X = NPO TCN2X = X7R	<b>62</b> <b>63</b> <b>64</b> <b>65</b>		<b>Lead free version available for operating temperature up to 175° C (contact your sales representative)</b>			
<b>Up to 250° C</b> TCE5X = NPO TCN5X = X7R	<b>66</b>					

# TCE / TCN Self-Protected Series

High Temperature Self-Protected Capacitors

## DIMENSIONS in inches (mm)

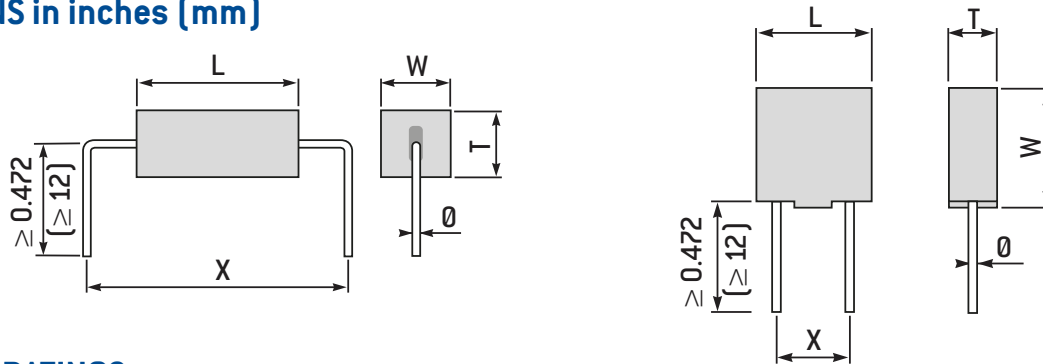

## STANDARD RATINGS

Exxelia size code		212		213		214		215		216		263				
Leads spacing code		-		-		-		-		-		2				
Dimensions inches (mm)	L	0.284 ± 0.012 (7.2 ± 0.3)		0.315 ± 0.012 (8 ± 0.3)		0.315 ± 0.012 (8 ± 0.3)		0.559 ± 0.012 (14.2 ± 0.3)		0.559 ± 0.012 (14.2 ± 0.3)		0.267 max (6.85 max)				
	W	0.244 ± 0.012 (6.2 ± 0.3)		0.315 ± 0.012 (8 ± 0.3)		0.315 ± 0.012 (8 ± 0.3)		0.417 ± 0.012 (10.6 ± 0.3)		0.417 ± 0.012 (10.6 ± 0.3)		0.1 max (2.54 max)				
	T max.	0.099 (2.5)		0.099 (2.5)		0.15 (3.8)		0.099 (2.5)		0.15 (3.8)		0.1 (2.54)				
	X	0.2 ± 0.008 (5.08 ± 0.2)		0.2 ± 0.008 (5.08 ± 0.2)		0.2 ± 0.008 (5.08 ± 0.2)		0.4 ± 0.008 (10.16 ± 0.2)		0.4 ± 0.008 (10.16 ± 0.2)		0.5 ± 0.02 (12.7 ± 0.5)   0.6 ± 0.02 (15.24 ± 0.5)				
	Ø ± 10%	0.024 (0.6)		0.024 (0.6)		0.031 (0.8)		0.039 (1)		0.039 (1)		0.024 (0.6)				
Dielectric		NPO		X7R		NPO		X7R		NPO		X7R				
Min. Capacitance value		10pF		3.3nF		270pF		15nF		680pF		22nF				
Rated voltage (U <sub>RC</sub> )	20°C	200°C	220°C	250°C												
	25V	12V	8V	5V	-	-	-	-	-	-	-	-	8.2nF	180nF		
	50V	25V	16V	10V	6.8nF	390nF	12nF	680nF	22nF	1.2µF	33nF	1.8µF	56nF	3.9µF	4.7nF	120nF
	100V	50V	25V	16V	3.9nF	180nF	6.8nF	330nF	15nF	680nF	22nF	1µF	39nF	1.8µF	3.3nF	47nF
	500V	250V	125V	63V	-	-	-	-	-	-	-	-	-	-	330pF	-

Exxelia size code		264			265			266							
Leads spacing code		-			2			3							
Dimensions inches (mm)	L	0.4 max (10.16 max)			0.517 (13.2 max)			0.717 (18.2 max)							
	W	0.15 max (3.8 max)			0.264 max (6.7 max)			0.37 max (9.4 max)							
	T max.	0.15 (3.8)			0.158 (4)			0.158 (4)							
	X	0.6 ± 0.02 (15.24 ± 0.5)		0.7 ± 0.02 (17.78 ± 0.5)		1 ± 0.02 (25.4 ± 0.5)		0.7 ± 0.02 (17.78 ± 0.5)		0.9 ± 0.02 (22.86 ± 0.5)		0.95 ± 0.02 (24.13 ± 0.5)		1 ± 0.02 (25.4 ± 0.5)	
	Ø ± 10%	0.024 (0.6)			0.024 (0.6)			0.024 (0.6)							
Dielectric		NPO			X7R			NPO			X7R				
Min. Capacitance value		100pF			180pF			390pF			390pF				
Rated voltage (U <sub>RC</sub> )	20°C	200°C	220°C	250°C											
	25V	12V	8V	5V	27nF	560nF	68nF	1.8µF	150nF	3.3µF					
	50V	25V	16V	10V	15nF	330nF	39nF	1µF	100nF	1.8µF					
	100V	50V	25V	16V	10nF	120nF	22nF	330nF	56nF	820nF					

Available capacitance values:

NPO: E6, E12, E24 (see page 14). Specific values upon request.

X7R: E6, E12 (see page 14). Specific values upon request.

Exxelia can deliver axial leads on size code 262, 263, 264, 265, 266 to allow the customer to obtain the leads spacing needed (leads spacing code = 9). In that case we recommend to bend the connections at a distance from the ceramic body of 5mm minimum.

The above table defines the standard products, other components may be built upon request.

# High Temperature / High Voltage Capacitors

# TCH Series



## ELECTRICAL SPECIFICATIONS

Description	NPO	X7R
<b>Operating temperature</b>	-55°C to +250°C	-55°C to +250°C
<b>Rated voltage at 20°C</b>	200 V <sub>DC</sub> to 10,000 V <sub>DC</sub>	500 V <sub>DC</sub> to 5,000 V <sub>DC</sub>
<b>Dielectric withstanding voltage at 20°C</b>	1.25U <sub>RC</sub> for U <sub>RC</sub> = 500 V <sub>DC</sub> 1.5U <sub>RC</sub> for 500 V <sub>DC</sub> < U <sub>RC</sub> < 2,000 V <sub>DC</sub> 1.3U <sub>RC</sub> for U <sub>RC</sub> ≥ 2,000 V <sub>DC</sub>	1,000V for U <sub>RC</sub> = 500 V <sub>DC</sub> 1.5U <sub>RC</sub> for 500 V <sub>DC</sub> < U <sub>RC</sub> < 2,000 V <sub>DC</sub> 1.2U <sub>RC</sub> for U <sub>RC</sub> ≥ 2,000 V <sub>DC</sub>
<b>Capacitance</b>	at 1MHz for C ≤ 1,000pF at 1kHz for C > 1,000pF	at 1MHz for C ≤ 100pF at 1kHz for C > 100pF
<b>Dissipation factor at 20°C</b>	≤ 0.015 (150/C + 7)% at 1MHz for C ≤ 50pF ≤ 0.15% at 1MHz for 50pF < C ≤ 1,000pF ≤ 0.15% at 1kHz for C > 1,000pF	≤ 2.5% at 1MHz for C ≤ 100pF ≤ 2.5% at 1kHz for C > 100pF
<b>Dissipation factor at 200°C</b>	≤ 0.03 (150/C + 7)% at 1MHz for C ≤ 50pF ≤ 0.3% at 1MHz for 50pF < C ≤ 1,000pF ≤ 0.3% at 1kHz for C > 1,000pF	≤ 1.5% at 1MHz for C ≤ 100pF ≤ 1.5% at 1kHz for C > 100pF
<b>Dissipation factor at 220°C</b>	≤ 0.03 (150/C + 7)% at 1MHz for C ≤ 50pF ≤ 0.3% at 1MHz for 50pF < C ≤ 1,000pF ≤ 0.3% at 1kHz for C > 1,000pF	≤ 0.5% at 1MHz for C ≤ 100pF ≤ 0.5% at 1kHz for C > 100pF
<b>Dissipation factor at 250°C</b>	≤ 0.03 (150/C + 7)% at 1MHz for C ≤ 50pF ≤ 0.3% at 1MHz for 50pF < C ≤ 1,000pF ≤ 0.3% at 1kHz for C > 1,000pF	≤ 0.5% at 1MHz for C ≤ 100pF ≤ 0.5% at 1kHz for C > 100pF
<b>Insulation resistance at 20°C under U<sub>RC</sub> for U<sub>RC</sub> ≤ 500 V<sub>DC</sub> under 500 V<sub>DC</sub> for U<sub>RC</sub> &gt; 500 V<sub>DC</sub></b>	≥ 100,000Ω or ≥ 1,000Ω.μF (whichever is less)	≥ 100,000Ω or ≥ 1,000Ω.μF (whichever is less)
<b>Insulation resistance at 200°C under U<sub>RC</sub> for U<sub>RC</sub> ≤ 500 V<sub>DC</sub> under 500 V<sub>DC</sub> for U<sub>RC</sub> &gt; 500 V<sub>DC</sub></b>	≥ 1,000Ω or ≥ 20MΩ.μF (whichever is less)	≥ 1,000Ω or ≥ 10MΩ.μF (whichever is less)
<b>Insulation resistance at 220°C under U<sub>RC</sub> for U<sub>RC</sub> ≤ 500 V<sub>DC</sub> under 500 V<sub>DC</sub> for U<sub>RC</sub> &gt; 500 V<sub>DC</sub></b>	≥ 800Ω or ≥ 8MΩ.μF (whichever is less)	≥ 200Ω or ≥ 4MΩ.μF (whichever is less)
<b>Insulation resistance at 250°C under U<sub>RC</sub> for U<sub>RC</sub> ≤ 500 V<sub>DC</sub> under 500 V<sub>DC</sub> for U<sub>RC</sub> &gt; 500 V<sub>DC</sub></b>	≥ 200Ω or ≥ 2MΩ.μF (whichever is less)	≥ 100Ω or ≥ 1MΩ.μF (whichever is less)
<b>Ageing</b>	None	≤ 2.5% per decade hour

## FEATURES

- Multilayer Chips Ceramic Capacitors for operating temperature up to 250° C
- NPO and X7R dielectrics
- Capacitance range: 10pF to 15μF
- Voltage range at 20°C: 200 V<sub>DC</sub> to 10 kV<sub>DC</sub>

## PHYSICAL CHARACTERISTICS

### CONSTRUCTION

Varnished radial leaded chips capacitors for through-hole circuits.

### MARKING (clear or coded)

Series, capacitance value, tolerance, voltage, date code.

## HOW TO ORDER

Series	Dielectric code	Size code	Capacitance	Tolerance	Rated voltage at 20°C
TCH	2	85	6.8nF	20%	3,000 V
TCH2X					
TCH5X					
<b>Operating temperature</b>	<b>1 = NPO</b> <b>2 = X7R</b>	<b>79</b> <b>80</b> <b>81</b> <b>82</b> <b>83</b> <b>84</b> <b>89</b> <b>85</b> <b>87</b> <b>88</b>	Capacitance value in clear	<b>For NPO dielectric:</b> ± 1% ± 2% ± 5% ± 10% ± 20%  <b>For X7R dielectric:</b> ± 10% ± 20%	<b>200 V</b> <b>500 V</b> <b>1 kV</b> <b>2 kV</b> <b>3 kV</b> <b>4 kV</b> <b>5 kV</b> <b>7.5 kV</b> <b>10 kV</b>  Intermediary and higher voltages available: contact your sales representative.

RoHS and Lead free compliant parts are available: contact your sales representative.

# TCH Series

High Temperature / High Voltage Capacitors

## DIMENSIONS in inches (mm)

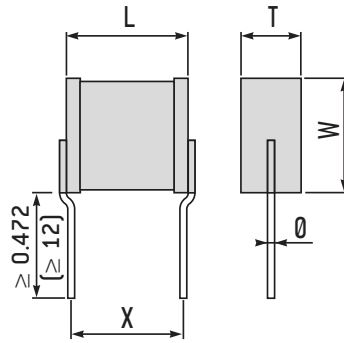

## STANDARD RATINGS (NPO)

Size		1812	2220	2825	3333	4040	5440	5550	6560	11283	16080					
Exxelia size code		79	80	81	82	83	84	89	85	87	88					
Dimensions inches (mm)	L max	0.237 (6)	0.276 (7)	0.355 (9)	0.394 (10)	0.473 (12)	0.63 (16)	0.642 (16.3)	0.729 (18.5)	1.182 (30)	1.674 (42.5)					
	W max	0.197 (5)	0.276 (7)	0.296 (7.5)	0.394 (10)	0.493 (12.5)	0.493 (12.5)	0.619 (15.7)	0.689 (17.5)	0.886 (22.5)	0.827 (21)					
	T max	0.138 (3.5)	0.150 (3.8)	0.237 (6)	0.237 (6)	0.237 (6)	0.237 (6)	0.237 (6)	0.237 (6)	0.237 (6)	0.256 (6.5)	0.256 (6.5)				
	Ø ± 10%	0.024 (0.6)	0.024 (0.6)	0.031 (0.8)	0.031 (0.8)	0.031 (0.8)	0.031 (0.8)	0.039 (1)	0.039 (1)	0.039 (1)	0.039 (1)	0.039 (1)				
	X	0.2 ± 0.020 (5.08 ± 0.5)	0.2 ± 0.020 (5.08 ± 0.5)	0.3 ± 0.020 (7.62 ± 0.5)	0.4 ± 0.020 (10.16 ± 0.5)	0.5 ± 0.020 (12.7 ± 0.5)	0.6 ± 0.020 (15.24 ± 0.5)	0.6 ± 0.020 (15.24 ± 0.5)	0.6 ± 0.020 (15.24 ± 0.5)	0.7 ± 0.020 (17.8 ± 0.5)	1.1 ± 0.020 (27.94 ± 0.5)	1.6 ± 0.020 (40.64 ± 0.5)				
Min. Capacitance value		10pF	10pF	18pF	33pF	10pF	22pF	27pF	47pF	120pF	150pF					
Rated voltage (U <sub>ric</sub> )	20°C	200V	130V	220°C	100V	50V	18nF	22nF	56nF	100nF	180nF	270nF	220nF	560nF	1µF	1.2µF
	500V	330V	250V	125V	10nF	18nF	27nF	68nF	100nF	150nF	150nF	270nF	270nF	470nF	820nF	820nF
	1kV	500V	300V	200V	5.6nF	6.8nF	12nF	33nF	47nF	68nF	82nF	120nF	270nF	270nF	470nF	470nF
	2kV	1kV	650V	500V	820pF	1nF	2.7nF	6.8nF	10nF	15nF	18nF	27nF	27nF	56nF	82nF	82nF
	3kV	1.5kV	1kV	600V	390pF	470pF	1nF	1.8nF	3.3nF	5.6nF	10nF	10nF	27nF	27nF	33nF	33nF
	4kV	2kV	1.3kV	800V	220pF	330pF	820pF	1.5nF	2.7nF	4.7nF	6.8nF	8.2nF	22nF	22nF	27nF	27nF
	5kV	2.5kV	1.6kV	1kV	-	220pF	560pF	1nF	2.2nF	3.9nF	4.7nF	6.8nF	15nF	15nF	18nF	18nF
	7.5kV	3.75kV	2.5kV	1.5kV	-	-	-	-	330pF	560pF	1.2nF	1.2nF	3.3nF	3.3nF	4.7nF	4.7nF
	10kV	5kV	3kV	2kV	-	-	-	-	220pF	390pF	680pF	820pF	2.2nF	2.2nF	3.3nF	3.3nF

## STANDARD RATINGS (X7R)

Size		1812	2220	2825	3333	4040	5440	5550	6560	11283	16080				
Exxelia size code		79	80	81	82	83	84	89	85	87	88				
Dimensions inches (mm)	L max	0.237 (6)	0.276 (7)	0.355 (9)	0.394 (10)	0.473 (12)	0.63 (16)	0.642 (16.3)	0.729 (18.5)	1.182 (30)	1.674 (42.5)				
	W max	0.197 (5)	0.276 (7)	0.296 (7.5)	0.394 (10)	0.493 (12.5)	0.493 (12.5)	0.619 (15.7)	0.689 (17.5)	0.886 (22.5)	0.827 (21)				
	T max	0.138 (3.5)	0.150 (3.8)	0.237 (6)	0.237 (6)	0.237 (6)	0.237 (6)	0.237 (6)	0.237 (6)	0.237 (6)	0.256 (6.5)	0.256 (6.5)			
	Ø ± 10%	0.024 (0.6)	0.024 (0.6)	0.031 (0.8)	0.031 (0.8)	0.031 (0.8)	0.031 (0.8)	0.039 (1)	0.039 (1)	0.039 (1)	0.039 (1)	0.039 (1)			
	X	0.2 ± 0.020 (5.08 ± 0.5)	0.2 ± 0.020 (5.08 ± 0.5)	0.3 ± 0.020 (7.62 ± 0.5)	0.4 ± 0.020 (10.16 ± 0.5)	0.5 ± 0.020 (12.7 ± 0.5)	0.6 ± 0.020 (15.24 ± 0.5)	0.6 ± 0.020 (15.24 ± 0.5)	0.6 ± 0.020 (15.24 ± 0.5)	0.7 ± 0.020 (17.8 ± 0.5)	1.1 ± 0.020 (27.94 ± 0.5)	1.6 ± 0.020 (40.64 ± 0.5)			
Min. Capacitance value		100pF	150pF	150pF	330pF	270pF	390pF	560pF	1nF	2.2nF	2.7nF				
Rated voltage (U <sub>ric</sub> )	20°C	200V	100V	60V	40V	220nF	390nF	820nF	1.5µF	2.7µF	3.9µF	4.7µF	6.8µF	12µF	15µF
	500V	250V	160V	100V	47nF	100nF	220nF	390nF	680nF	1µF	1.2µF	1.8µF	3.9µF	4.7µF	4.7µF
	1kV	500V	300V	200V	15nF	22nF	47nF	68nF	150nF	220nF	270nF	390nF	1µF	1.2µF	1.2µF
	2kV	1kV	650V	500V	3.3nF	5.6nF	10nF	18nF	33nF	68nF	68nF	100nF	220nF	220nF	330nF
	3kV	1.5kV	1kV	600V	1.2nF	2.2nF	3.9nF	6.8nF	15nF	27nF	27nF	39nF	100nF	100nF	120nF
	4kV	2kV	1.3kV	800V	680pF	1.2nF	2.7nF	4.7nF	10nF	15nF	18nF	27nF	68nF	68nF	100nF
	5kV	2.5kV	1.6kV	1kV	-	820pF	1.8nF	3.3nF	5.6nF	10nF	12nF	18nF	56nF	56nF	68nF
	7.5kV	3.75kV	2.5kV	1.5kV	-	-	-	-	1.5nF	2.7nF	3.3nF	6.8nF	18nF	18nF	27nF
	10kV	5kV	3kV	2kV	-	-	-	-	680pF	1.2nF	1.5nF	3.3nF	8.2nF	8.2nF	12nF

Available capacitance values:

NPO: E6, E12, E24 (see page 14). Specific values upon request.

X7R: E6, E12 (see page 14). Specific values upon request.

Exxelia can deliver axial leads on size code 262, 263, 264, 265, 266 to allow the customer to obtain the leads spacing needed (leads spacing code = 9). In that case we recommend to bend the connections at a distance from the ceramic body of 5mm minimum.

The above table defines the standard products, other components may be built upon request.



# FEED-THRU

GENERAL INFORMATION ..... 114

## TBC SERIES

Discoidal Capacitors ..... 115

## BPM SERIES

Planar Arrays ..... 117



# General Information

Discoidal capacitors with NPO, X7R ceramics (BX and BR available on request) feature unique frequency performance due to very low inductance inherent to the configuration.

They are ideally suited to interconnect power amplifier stages through a shielding wall (high impedance electronic circuits).

Silver-palladium terminations can be directly mounted on the metal surface of the shielding wall.

Multiple lines can be filtered simultaneously using the BPM Series which consist of multiple capacitors in the same component. These capacitors can have the same or different values. EXXELIA expertise and flexible manufacturing processes enable a wide range of arrays: custom configuration or geometry. Consult our Engineering team to support your design requirements.

Another version (option T) featuring central conductor configuration (illustrated below) enables to get rid of thermal and mechanical shocks inherent to lead soldering. This also eliminates the risks of plating deterioration during the soldering process.

At last 2 lines can be filtered simultaneously using the BPM 12 or BPM 22 which consists of two capacitors in the same component (4 lines with the BPM24 or BPM224). These capacitors can have the same or different values (consult us).

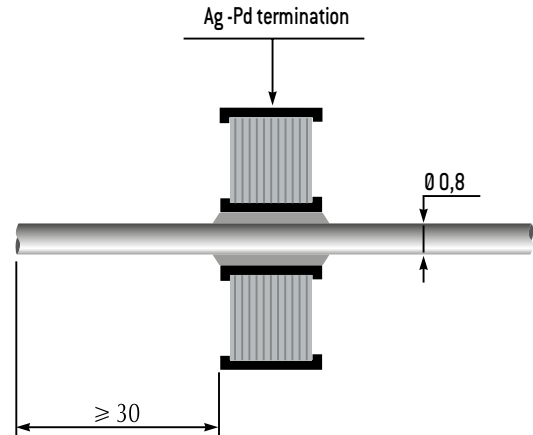

**NPO: TYPICAL ATTENUATION CURVE VERSUS FREQUENCY (50Ω IMPEDANCE)**

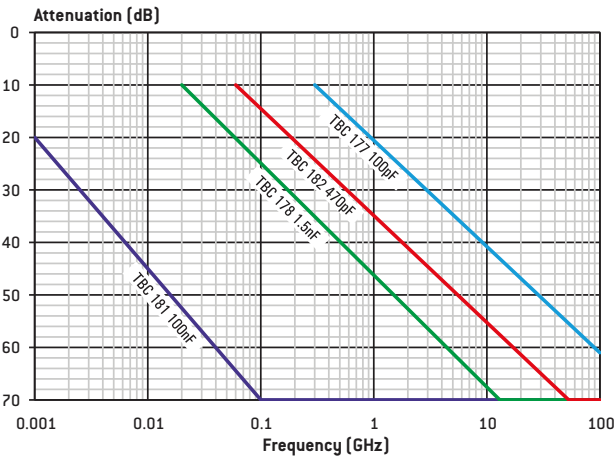

**X7R: TYPICAL ATTENUATION CURVE VERSUS FREQUENCY (50Ω IMPEDANCE)**

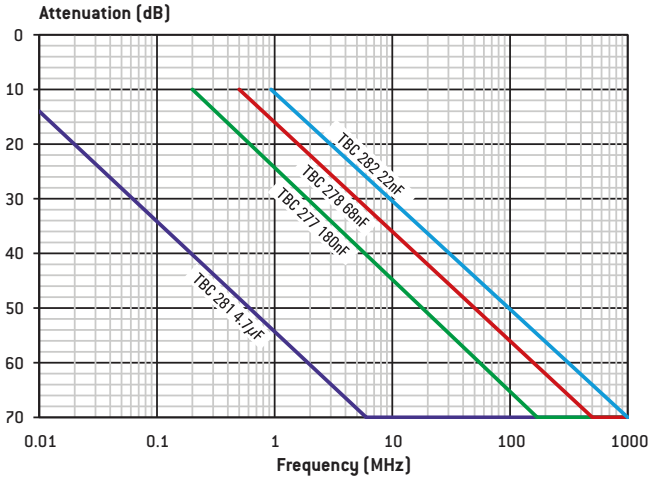

# Discoidal Capacitors

# TBC Series

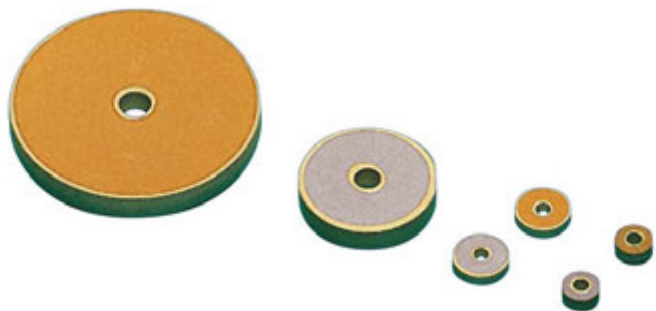

## FEATURES

- Discoidal Multilayer Ceramic Capacitors
- Diameters: 0.053" (1.35 mm)– 0.61" (15.5 mm)
- NPO and X7R dielectrics
- Very low ESL
- Capacitance range: 10pF to 12μF
- Voltage range: 25V<sub>DC</sub> to 1,000V<sub>DC</sub>

## PHYSICAL CHARACTERISTICS

### CONSTRUCTION

Discoidal multilayer capacitors with Silver/Palladium/Platinum terminations.

Option T: central lead enables to get rid of thermal, mechanical shocks and plating deterioration during soldering process.

### MARKING (on packaging)

Series, capacitance value, tolerance, rated voltage, batch number.

## ELECTRICAL SPECIFICATIONS

Description	NPO	X7R
<b>Operating temperature</b>	-55°C to +125°C	-55°C to +125°C
<b>Maximum ΔC/C over temperature range without DC voltage applied</b>	NA	± 15%
<b>Temperature coefficient</b>	(0 ± 30)ppm/°C	NA
<b>Climatic category</b>	55 / 125 / 56	55 / 125 / 56
<b>Dielectric withstanding voltage at 25° C</b>	2.5 U <sub>RC</sub> for U <sub>RC</sub> ≤ 500V 1.5 U <sub>RC</sub> for U <sub>RC</sub> > 500V	2.5 U <sub>RC</sub> for U <sub>RC</sub> ≤ 500V 1.5 U <sub>RC</sub> for U <sub>RC</sub> > 500V
<b>Capacitance</b>	at 1MHz for C ≤ 1,000pF at 1kHz for C > 1,000pF	at 1MHz for C ≤ 100pF at 1kHz for C > 100pF
<b>Dissipation factor at 25° C</b>	≤ 0.015 (150/C + ?)% at 1MHz for C ≤ 50pF ≤ 0.15% at 1MHz for 50pF < C ≤ 1,000pF ≤ 0.15% at 1kHz for C > 1,000pF	≤ 2.5% at 1MHz for C ≤ 100pF ≤ 2.5% at 1kHz for C > 100pF
<b>Insulation resistance at 25° C under U<sub>RC</sub> for U<sub>RC</sub> ≤ 500V under 500V for U<sub>RC</sub> &gt; 500V</b>	≥ 20,000MΩ for C ≤ 25nF ≥ 500MΩ.μF for C > 25nF	≥ 20,000MΩ for C ≤ 25nF ≥ 500MΩ.μF for C > 25nF
<b>Aging</b>	None	≤ 2.5% per decade hour

BX and BR dielectrics available on request.

## HOW TO ORDER

TBC	2	81	W	T	10nF	10%	100 V
Series	Dielectric code	Exxelia size code	RoHS compliant	Central conductor	Capacitance	Tolerance	Rated voltage
TBC = discoidal capacitors	1 = NPO 2 = X7R	14 82 78 99 77 12 13 81	- = No RoHS W = RoHS compliant	-: no central lead T = Central lead requested	Capacitance value in clear	NPO: ± 1% (Cap. value ≥ 27pF) ± 2% (Cap. value ≥ 15pF) ± 5% ± 10% ± 20%  X7R: ± 10% ± 20%	25 V 50 V 100 V 150 V 200 V 250 V 300 V 500 V 1,000 V

### DIMENSIONS in inches (mm)

Discoidal capacitor

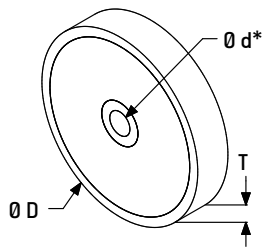

Discoidal capacitor with central lead

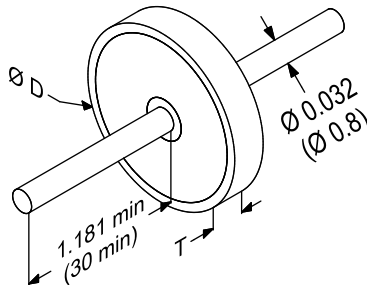

### STANDARD RATINGS

Size	14		82		78		99		77		12		13		81		
Dimensions inches (mm)	D	0.053 ± 0.002 (1.35 ± 0.05)		0.098 ± 0.008 (2.5 ± 0.2)		0.138 ± 0.008 (3.5 ± 0.2)		0.256 ± 0.008 (6.5 ± 0.2)		0.335 ± 0.008 (8.5 ± 0.2)		0.373 ± 0.005 (9.47 ± 0.13)		0.502 ± 0.008 (12.75 ± 0.2)		0.61 ± 0.008 (15.5 ± 0.2)	
	d max.	0.022 (0.55)		0.04 (1)		0.04 (1)		0.048 (1.2)		0.063 (1.6)		0.063 (1.6)		0.079 (2)		0.079 (2)	
	T max.	0.04 (1)		0.119 (3)		0.119 (3)		0.099 (2.5)		0.119 (3)		0.119 (3)		0.119 (3)		0.119 (3)	
<b>Dielectric</b>	<b>NPO</b>	<b>X7R</b>	<b>NPO</b>	<b>X7R</b>	<b>NPO</b>	<b>X7R</b>	<b>NPO</b>	<b>X7R</b>	<b>NPO</b>	<b>X7R</b>	<b>NPO</b>	<b>X7R</b>	<b>NPO</b>	<b>X7R</b>	<b>NPO</b>	<b>X7R</b>	
<b>Exxelia dielectric code</b>	1	2	1	2	1	2	1	2	1	2	1	2	1	2	1	2	
<b>Min. Capacitance value</b>	10pF	100pF	10pF	100pF	15pF	100pF	18pF	100pF	47pF	100pF	56pF	150pF	82pF	390pF	100pF	820pF	
<b>Rated voltage (U<sub>rc</sub>)</b>	<b>25V</b>	100pF	2.2nF	3.3nF	82nF	12nF	390nF	68nF	1.8µF	100nF	2.7µF	120nF	3.9µF	330nF	8.2µF	390nF	12µF
	<b>50V</b>	100pF	1.5nF	3.3nF	68nF	12nF	330nF	68nF	1.5µF	100nF	2.2µF	120nF	3.3µF	330nF	6.8µF	390nF	10µF
	<b>100V</b>	56pF	470pF	2.2nF	22nF	10nF	100nF	47nF	820nF	82nF	1µF	100nF	1.2µF	220nF	2.7µF	330nF	3.9µF
	<b>150V</b>	-	-	1.2nF	18nF	5.6nF	82nF	22nF	470nF	47nF	820nF	56nF	1µF	120nF	2.2µF	180nF	2.7µF
	<b>200V</b>	-	-	1nF	15nF	3.9nF	68nF	18nF	330nF	33nF	680nF	39nF	820nF	82nF	1.8µF	120nF	2.2µF
	<b>250V</b>	-	-	-	-	3.3nF	47nF	12nF	220nF	22nF	390nF	33nF	560nF	68nF	1.2µF	82nF	1.5µF
	<b>300V</b>	-	-	-	-	2.2nF	33nF	10nF	180nF	18nF	330nF	27nF	470nF	56nF	1µF	68nF	1.2µF
	<b>500V</b>	-	-	-	-	-	-	6.8nF	150nF	15nF	270nF	18nF	330nF	39nF	820nF	56nF	1µF
	<b>1,000V</b>	-	-	-	-	-	-	4.7nF	15nF	10nF	33nF	12nF	47nF	27nF	100nF	39nF	120nF

\* Diameter d can be different: consult your sales representative

Available capacitance values:

NPO: E6, E12, E24, E48, E96 (see page 14). Specific values upon request.

X7R: E6, E12 (see page 14). Specific values upon request.

The above table defines the standard products, other components may be built upon request.



## FEATURES

- Planar capacitor arrays
- X7R dielectrics (NPO available on request)
- Capacitance range: 330pF - 68nF
- Voltage range: 25V<sub>DC</sub> to 200V<sub>DC</sub>
- Specific configurations available on request

## PHYSICAL CHARACTERISTICS

### CONSTRUCTION

Circular or rectangular multilayer capacitor arrays with Silver / Palladium / Platinum terminations. Other shapes available on request.

### MARKING (on packaging)

Series, capacitance value, tolerance, rated voltage, batch number.

## ELECTRICAL SPECIFICATIONS

Description	X7R
Operating temperature	-55°C to +125°C
Maximum $\Delta C/C$ over temperature range without DC voltage applied	± 15%
Climatic category	55 / 125 / 56
Rated voltage (U <sub>RC</sub> )	25V <sub>DC</sub> to 200V <sub>DC</sub>
Dielectric withstanding voltage at 25°C between holes and outside	2.5 U <sub>RC</sub>
Capacitance	at 1kHz
Dissipation factor at 25°C	≤ 2.5% at 1kHz
Insulation resistance at 25°C under U <sub>RC</sub>	≥ 20,000MΩ
Aging	≤ 2.5% per decade hour

NPO, BX and BR dielectrics available on request.

## HOW TO ORDER

BPM	22	W	470nF	10%	200 V
Series	Design code	RoHS compliant	Capacitance	Tolerance	Rated voltage
BPM = Planar arrays	22 = 2 capacitors - discoidal shape 224 = 4 capacitors - discoidal shape 24 = 4 capacitors - rectangular shape	- = No RoHS W = RoHS compliant	Capacitance value in clear	± 10% ± 20%	25 V 50 V 100 V 200 V

# BPM Series

## DIMENSIONS

Design code 22

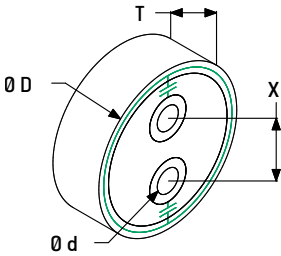

Design code 224

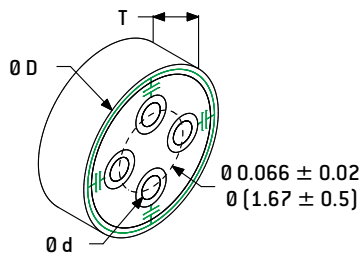

Design code 24

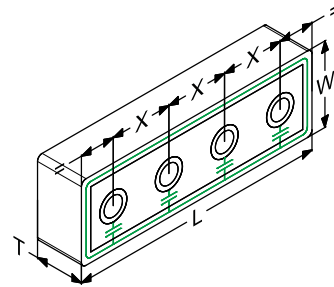

Black lines: mechanical

Green lines: electrical (external termination is connected to the ground)

## STANDARD RATINGS

Size		BPM22	BPM224	BPM24
Dimensions Inches [mm]	L ±0.008 [±0.2]	-	-	0.248 [6.3]
	W ±0.008 [±0.2]	-	-	0.081 [2.05]
	D ±0.004 [±0.1]	0.142 [3.6]	0.12 [3.05]	-
	d ±0.002 [±0.05]	0.022 [0.55]	0.019 [0.49]	-
	T max.	0.048 [1.2]	0.05 [1.25]	0.048 [1.2]
	X ±0.002 [±0.05]	0.056 [1.42]	-	0.06 [1.52]
Min. Capacitance value		330pF	330pF	330pF
Rated voltage (U <sub>r,c</sub> )	25V	68nF	12nF	56nF
	50V	39nF	4.7nF	27nF
	100V	18nF	2.7nF	12nF
	200V	8.2nF	-	5.6nF

Available capacitance values:

E6, E12 [see page 14]. Specific values upon request.

For standard products capacitance value is the same for each hole, it can be different on request.

The above table defines the standard products, other components may be built upon request (NPO, BX, BR, shapes, number of holes, combination of capacitance values, etc.)

# HIGH Q

GENERAL INFORMATION ..... 120

## CH SERIES

Classic HiQ ..... 129

## SH SERIES

Super HiQ ..... 132

## SHR/SHD SERIES

Reverse Geometry ..... 135

## NHB SERIES

High Self Resonant Frequency ..... 137

## CP SERIES

High Power ..... 139

## CL SERIES

High Power ..... 143

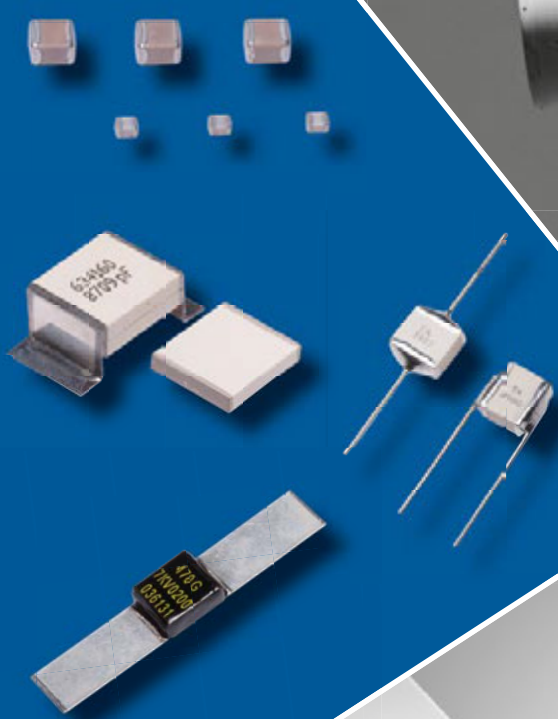

# General Information

## CAPACITOR TERMINATIONS AND SOLDERING RECOMMENDATIONS

### I. TERMINATION TYPES

Our capacitors are delivered with one of the following terminations (for technical reasons, only a limited number of termination types are available in certain cases). All our terminations are backward compatible.

Parameter	Value	Comment
Termination Materials	A	non-magnetic (silver-palladium)
	C	non-magnetic (pure tin over copper barrier)
	S	lead-free (pure tin over nickel barrier)

NB:

- terminations type C recommended for non magnetic applications.
- termination type A available for non magnetic applications (for historical reason, we have also another code, the code "P", for the same type of termination. The parts that were designed-in before 2005 might still have a code "P" instead of "A" in the part numbering. But both codes correspond to the same type of termination).

### II. SPECIFICATIONS

Care must be taken when using particular terminations: if the terminations are heated up above a particular temperature and/or for too long a period of time, there is a risk of leaching (dissolution of the termination revealing the inner electrodes).

The chart below gives the resistance to soldering heat per termination type, based on a SAC387 solder bath at 260°C.

Dielectric Type	A	C	S
CHA / SHA		10 ± 1s [3]	120 ± 5s
CHB / SHB		30 ± 2s	120 ± 5s
CPX / CLX / CPE / CLE		30 ± 2s	120 ± 5s
CLF	10 ± 2s [1]	On request	120 ± 5s
SHL			120 ± 5s
SHS		10 ± 1s [4]	120 ± 5s
SHF / SHN / SHT	5 ± 1s [2]		120 ± 5s

- [1]: results extrapolated from 30 ± 2s data obtained with Sn62/Pb36/Ag2 solder bath.
- [2]: data obtained with Sn62/Pb36/Ag2 solder bath.
- [3]: termination only available on CHA series.
- [4]: preliminary data.

### III. STANDARD SMD REQUIREMENTS

#### III.1. Soldering Recommendations

Regarding the soldering attachments, three methods are generally used: the vapor phase soldering, the infrared reflow soldering and the wave soldering. Unless particular skill about the use of the wave soldering, this method is not recommended since the melted solder is directly in contact with the ceramic. This can potentially crack the capacitor because the ceramic is sensible to the thermal shocks. Moreover, this method needs to maintain the components with an insulating resin which increases the thermo-mechanical strains between the ceramic and the board both on soldering phase and operating

condition. The vapour phase and IR reflow soldering are less aggressive, inducing more restricted thermal shocks. This is the reason why they are preferred to the wave soldering method for reliable applications. In all cases, proper pre-heating is essential.

The circuit should be pre-heated at a typical rate of 1°C/s within 65°C to 100°C of the maximum soldering temperature. While multilayer ceramic capacitors can withstand the peak soldering temperatures for short durations, they should be minimized whenever possible.

Above precaution given for SMD types are applicable for the implementation of large bare chips (1515 and above). But in general, large bare chips above 2225 are not recommended to be mounted on epoxy printed board due to the thermal expansion mismatch between ceramic capacitor body and epoxy. This is the reason why leaded components will be preferred especially for reliable applications.

For information, the typical thermal profiles of these three soldering processes are given hereafter. These typical diagrams are only given as an aid to SMD users in determining specific processes linked to their instrumentations and to their own experience.

NB: reference documents are IEC 61760-1, CECC30000 and IEC68 standards. Please, refer to this standard for more information.

#### III.1.1. Vapour Phase Soldering

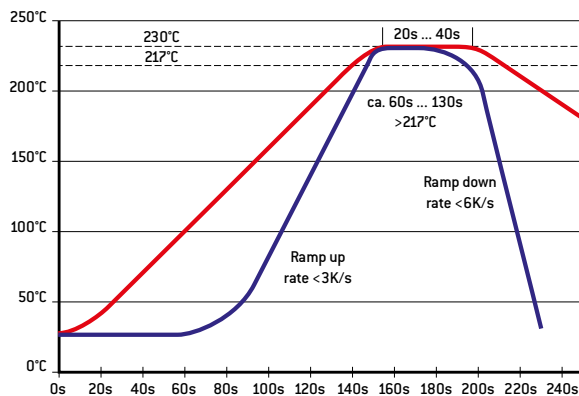

Lead free SnAgCu solders - Vapour Phase

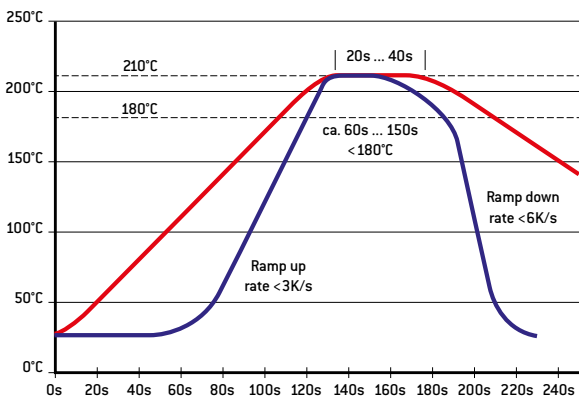

SnPb solders – Infrared Soldering

NB: the lines indicate the upper and lower limits of typical process (terminal temperature).



# General Information

## III.1.2. Infrared Soldering

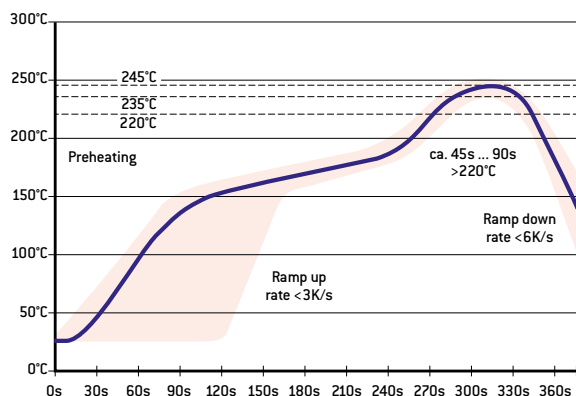

Lead free SnAgCu solders – Infrared Soldering

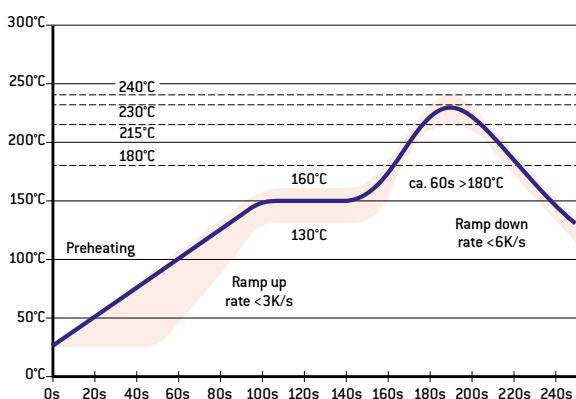

SnPb solders – Infrared Soldering

NB:

- these profiles are given for mid size components.
- continuous lines: typical process (terminal temperature).
- dotted lines: process limits, bottom process limit (terminal temperature), upper process limit (top surface temperature).

## III.1.3. Wave Soldering

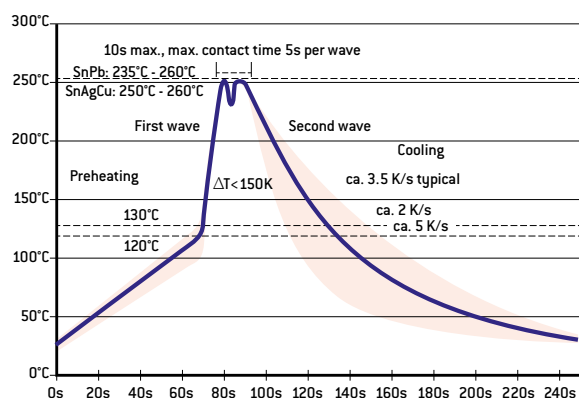

SnAgCu and SnPb solders - Double Wave Soldering

- NB:
- continuous lines: typical process.
  - dotted lines: process limits.

## III.2. Moisture Sensitivity Classification

Our standard lead-free terminations - S and C types - have been fully tested and are compliant with the requirements mentioned in specification JEDEC STD 020 (level 1: not moisture sensitive).

## III.3. Whiskers Classification

Our standard lead-free terminations - S and C types - have been fully tested and are compliant with the requirements mentioned in specification JEDEC STD 201. Our terminations exhibit a matte finish and receive a special heat treatment to relieve stress inside the tin.

## III.4. Pad Dimensions

The metallized pads on the end user's substrate must be properly designed. Improper spacing or dimensioning of the pads may result in poor solder joints or a tombstone effect. Pad designs are given below for the most common sizes of multilayer ceramic capacitors for both wave and reflow soldering.

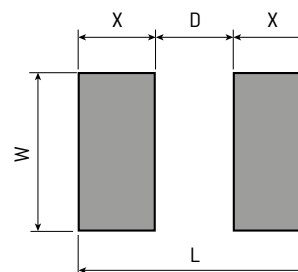

Case Size	W	X	D	L
SHL (0402)	0.70mm	0.90mm	0.40mm	2.20mm
CHA / SHA (0505)	1.80mm	1.00mm	0.80mm	2.80mm
SHS (0603)	1.00mm	1.10mm	0.60mm	2.80mm
SHF (0805)	1.50mm	1.30mm	0.60mm	3.20mm
CHB / SHB (1111)	3.00mm	1.00mm	1.90mm	3.90mm
CPX / CLX (2225)	6.90mm	1.00mm	5.00mm	7.00mm
CPE / CLE (4040)	10.20mm	1.00mm	8.30mm	10.30mm

NB: these dimensions are suggested for a reflow soldering process. If a wave soldering process is used, the X dimension has to be increased by 0.50mm (0.40mm for L and A case sizes), thus leading to an increase of 1.00mm to the L dimension (0.80mm for L and A case sizes).

# General Information

## SERIAL AND PARALLEL RESONANCE FREQUENCIES (SRF & PRF) OF CAPACITORS ON PCB

### I. INTRODUCTION AND DEFINITIONS

The equivalent model for a capacitor is usually defined by the figure 1 where:

- C** is the capacitance of the Capacitor
- RS** is the equivalent serial resistance [ESR]
- L** is the equivalent serial inductance [ESL]
- Cp** is the parasitic parallel capacitance
- Rp** is the Insulation Resistance

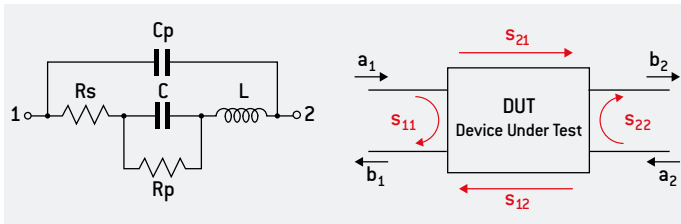

Figure 1: Equivalent Model

Figure 2: S parameters

The complex impedance Z is defined by:

$Z = ESR + jX$  and  $z = Z/Z_0$  [1] where z is the reduced impedance, X the reactance,  $Z_0$  the characteristic impedance (usually 50 ohm)

The impedance can be determined by the S parameters (figure 2) measurement for example with a serial configuration (Figure 3)

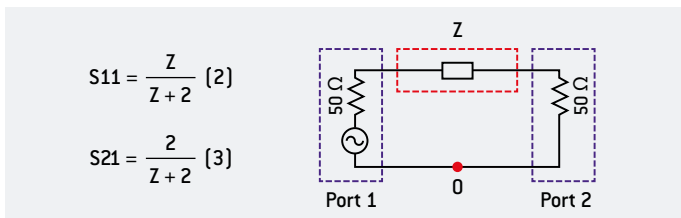

Figure 3: DUT Serial measurements

The variation of S11 (figure 4) and S21 (figure 5) show the different resonance frequencies SRF [serial resonance frequency] and PRF [parallel resonance frequency]

- The SRF is defined when the capacitor is a pure very small resistance:

$$SRF = \frac{1}{2\pi\sqrt{LC}} \quad (4a)$$

Therefore as X=0 the impedance defined in (1) is:

$$Z = ESR \quad (5)$$

At this frequency the ESR is usually low.

For example for a 251SHF150 (size 0805 and capacitance 15 pf): SRF=2.64 GHz and the ESR at this frequency is 0.200 ohm (figure 5)

- The PRF is associated with the parasitic capacitance Cp defined in figure 1. Assuming that  $C_p \ll C$ , then:

$$PRF \approx \frac{1}{2\pi\sqrt{LC_p}} \quad (4b)$$

At this frequency the impedance is a pure very high resistance.

For example for a 251SHF150:

PRF=3.66 GHz and the ESR at this frequency is very high (figure 6)

The PRF could be determined by the S21 measurements (figure 5)

The lumped model shown in Fig. 1 explains only the existence of one serial self-resonant frequency and one parallel self-resonant frequency, consequently, the lumped model is unable to explain why real measurements exhibits a double infinity of self-resonant frequencies (see figures 4, 5 & 6).

It is currently admitted [1] that the lumped model shown in Fig. 1 is convenient only for frequencies that are lower than roughly the half of the first SRF. For frequencies close or above the first SRF, it is mandatory to consider the distributed model or transmission line model [1].

This distributed model can be established more easily with the equivalent circuit of a Single Layer Capacitor (SLC) shown in Fig. 7:

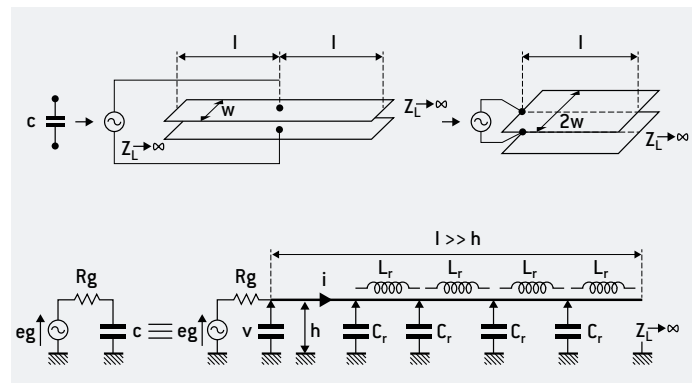

Figure 7: Transmission line model of a Single Layer Capacitor

After examination of Fig. 7, one can see that a Single Layer Capacitor can be modeled by a transmission line with an open termination that is currently called an "open stub".

According to classical courses relatives to transmission lines theory, it is well known that the variation with frequency of the input impedance of an open stub is given by:

$$Z_e = -jZ_c \cdot \cot g \left( \frac{2\pi l}{\lambda} \right) = -jZ_c \cdot \cot g \left( \frac{2\pi l}{c} f \right) \quad (5)$$

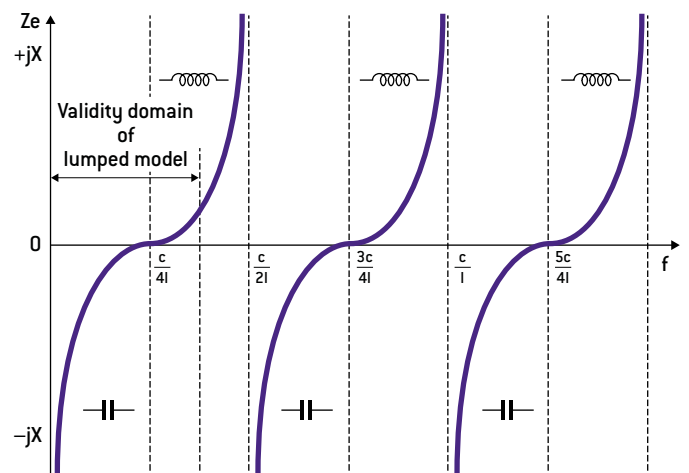

Figure 8: Plot of the theoretical expression (5) of the impedance of a Single Layer Capacitor modeled by an open stub

# General Information

The plot of the theoretical expression [5] of the impedance of a Single Layer Capacitor is shown in Fig. 8. As one can see, this theoretical curve predicts a double infinity of self-resonant frequencies (alternances of serial and parallel resonances) that are identical to the ones encountered in real world measurements.

Consequently, for predicting and understanding the behavior of a capacitor at frequencies that are close or above the first SRF, the lumped model (shown in Fig. 1) is not applicable and must be replaced by the distributed model or transmission line model (shown in Fig. 7).

Furthermore, according to [1], the transmission line model predicts accurately that the serial or parallel self-resonances are doubled when a capacitor chip is mounted with its internal electrodes oriented vertically (once again, it is impossible to predict such a phenomenon with the lumped model).

If now we take a closer look at a capacitor used as a coupling capacitor in a wide band application, it is evident when looking at fig. 8 that the coupling function will be correctly fulfilled at frequencies close to the serial resonant frequencies, since the capacitor's impedance is very low.

Conversely, the contrary will be encountered at the parallel resonant frequencies since the capacitor's impedance is very high and consequently the coupling function is not fulfilled.

Therefore in the application we must avoid to be at PRF. The High ESR may involve power loss and increase of internal temperature, since:

$$P = ESR I^2 \quad [6]$$

$$P = \frac{\Delta T}{R_{TH}} \quad (\text{stationary state}) \quad [7]$$

The temperature increase is therefore:

$$\Delta T = ESR I^2 R_{TH} \quad [8]$$

Where Rth is the thermal resistance of the capacitor with the PCB.

At first glance, equations [6], [7] & [8] confirm an increase of the internal temperature, but a closer look at these equations reveals that this temperature rise takes place only if the current I is constant. The problem is that in real applications the power source is rarely a pure current generator. More often than none, the power source is the dual of a current generator ie. a pure voltage generator. In the case of a circuit powered by a pure voltage generator, the contrary of the preceding behavior will be encountered at PRF since, as the capacitor's impedance is very high, the current I is very low and consequently, according to [6], [7] & [8] the temperature rise is not obvious or may be a temperature fall.

From these considerations, one can draw the conclusion that when a coupling capacitor is used at its PRF, for predicting an eventual temperature rise it is also mandatory to know for the PRF the behavior of the generator and the load between which the coupling capacitor is serially inserted.

In other words, the coupling capacitor is not the only cause of a temperature rise and consequently, the characteristics of the whole circuitry must be well known and understood prior to investigate the reasons of a temperature rise.

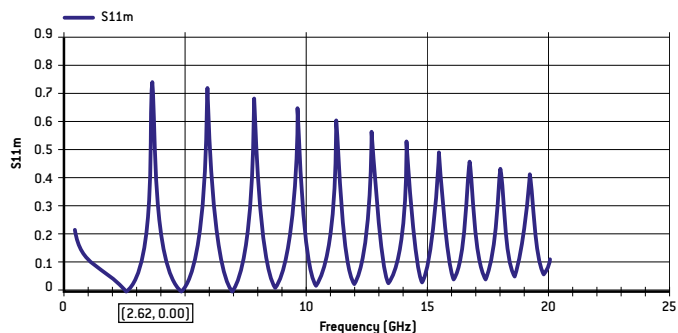

Figure 4: S11curve for a 251SHF150 from EXXELIA ABC software

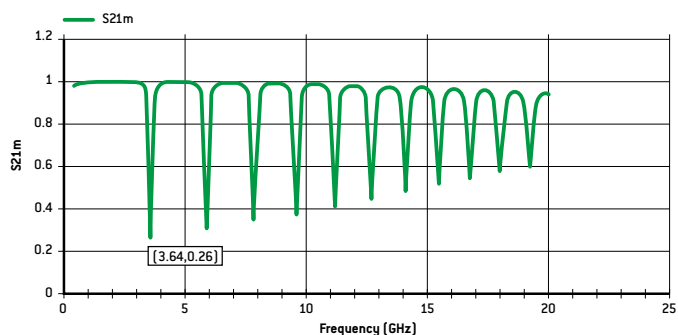

Figure 5: S21curve for a 251SHF150 from EXXELIA ABC software

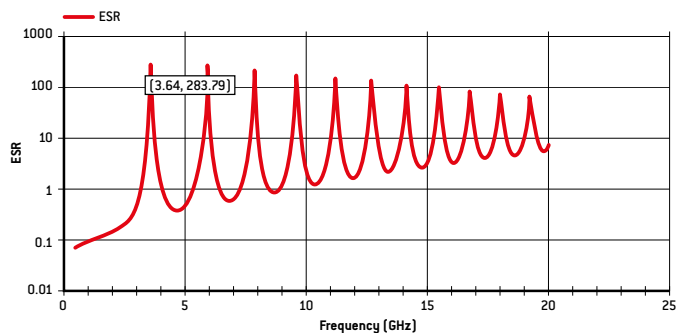

Figure 6: ESR curve for a 251SHF150 from EXXELIA ABC software

# General Information

## II. PARAMETERS OF SUBSTRATES AND CAPACITORS WHICH INFLUENCES THE PRF

As the PRF is linked to the parasitic parallel capacitance, when the capacitor is mounted on a PCB, the main parameters which could influence the PRF are:

- PCB parameters
- Capacitor parameters
  - Capacitance value
  - Geometry and size
  - Electrode orientation (horizontal or vertical)
  - Internal design

For example in the following screen plots, we can see that the first PRF is about 1.8GHz when the capacitor is mounted horizontally and is not visible when it is mounted vertically.

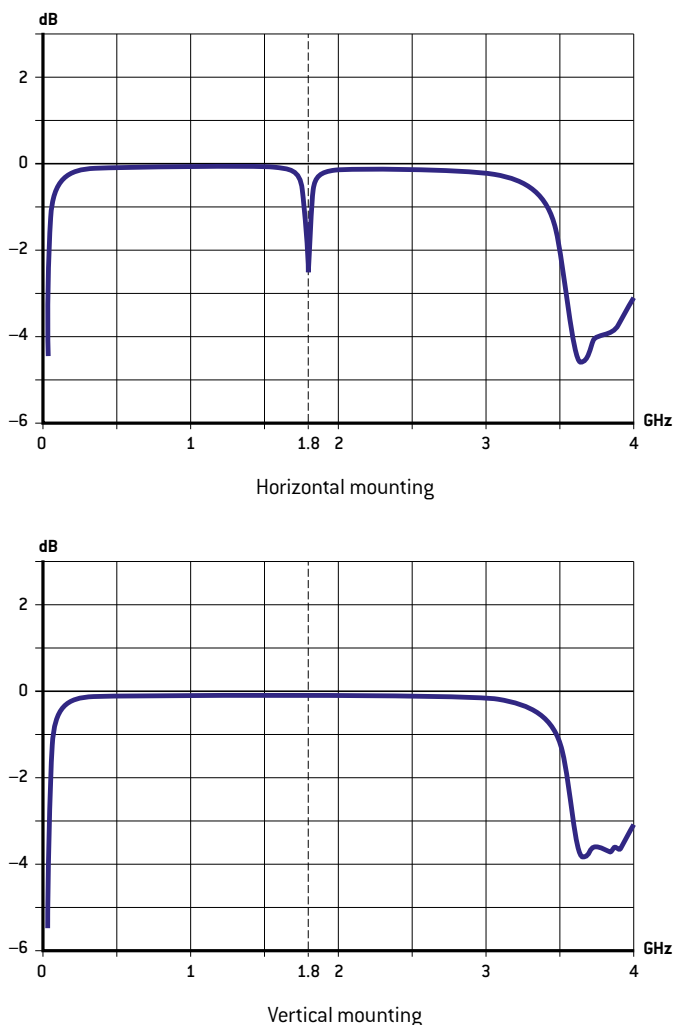

**Figure 9:** Example of PRF measurement (501SHB390JS on a FR4 PCB horizontal and vertical mounting)

[1] Monolithic Capacitors as Transmission Lines. Marc INGALLS and Gordon KENT IEE Transactions on Microwaves Theory and Techniques, Vol. MTT-35, N°11 november1987, pp. 964-970.

## CAPACITOR RELIABILITY DATA MIL-STD CDR STYLES, RF & AMP; MICROWAVE SYSTEMS

### I. TYPICAL RELIABILITY TESTS

- Adhesive Strength of Termination
- Bending Strength
- Solderability of Termination
- Resistance to Soldering Heat
- Thermal shock -55°C to +125°C
- Humidity Load (240 hours, 85% relative humidity at +85°C)
- High Temperature Load (1000/2000h, 125°C, x U<sub>N</sub>)

### II. RELIABILITY DATA MONITORING

#### II.1. General Manufacturing Process

At each step of the manufacturing process, specific checks have been set-up to guarantee the quality level of our products. Statistical Process Controls (also known as SPC) are utilized to monitor key parameters within processes.

In addition to all these in-process controls, a sample of capacitors from each lot is micro-sectioned to check the internal structure and the absence of voids, delaminations, cracks or other defects.

When manufacturing is completed, the multilayer ceramic capacitors are fully screened for Capacitance, Dissipation Factor, Dielectric Withstanding Voltage, Insulation Resistance and Visual Defects.

#### II.2. Reliability Testing

During qualification of new capacitor series or at random intervals, Temex Ceramics performs life tests – 2,000 hours, +125°C, 2 x WVDC - and uses MIL-PRF-55681 as a guideline. The following parameters best describe our multilayer ceramic capacitors for military applications:

- data from MIL-PRF- 55681 revision F;
- capacitor, chip, multiple layer, fixed, ceramic dielectric, established reliability;
- rated temperature: -55°C to +125°C;
- CDR11, CDR12, CDR13 and CDR14 case sizes;
- Failure Rate levels C, M, P, R and S.

The data obtained from our continuous life test monitoring are used to calculate an equivalent part failure rate and to compare it to the Failure Rate level as defined in MIL-PRF-55681F. The methods and formulae used are based on MIL-HDBK271F and MIL-STD-690D.

An acceleration factor of 8:1 is used to relate life test data obtained at 200% rated voltage at maximum rated temperature, to rated voltage at maximum rated temperature (125°C). The following formula is used:

$$AF = \left( \frac{V}{V_0} \right)^3 \times 2^{\frac{T-T_0}{10}}$$

where V<sub>0</sub> is the rated voltage, T<sub>0</sub> the rated temperature, V and T the life test parameters.

### III. RELIABILITY DATA SUMMARY

As stated in MIL-STD- 690D, data are accumulated from sample units selected from a production run and produced with equipment and procedures normally used in production. One of the prerequisites for valid data is that all lots produced during the production period be represented. The data are from the same product in current production, i.e. data from products of preceding designs are not acceptable.

# General Information

### III.1. Failure Rate Level

The summary of all collected data gives the following results:

- cumulative unit hours in millions: 9.27;
- cumulative unit hours in millions with acceleration factor: 74.16;
- number of defects: 1.

We consider a single sampling plan based on a 90 percent confidence level: FRSP-90. For this FR sampling plan, MIL-STD- 690D gives the following criteria:

FR Level Symbol	Qualified FR Level (% per 1,000 hours)	Number of Failures Permitted
C	non-ER	N/A
M	1.0	1 over 0.389M hours
P	0.1	1 over 3.89M hours
R	0.01	1 over 38.9M hours
S	0.001	1 over 389M hours

EXXELIA Temex therefore complies with the requirements of C, M, P and R failure rate levels.

S failure rate level according to European Space Agency specifications 3009/035 and 3009/036.

### III.2. Mean Time To Failure

MTTF is the basic measure of reliability for non-repairable items. It is analogous to the more familiar MTBF (Mean Time Between Failures) used for systems which can be repaired and placed back in service after failure occurs. FR levels may be converted to mean time to failure (MTTF) as follows:

$$MTTF = \frac{100\ 000}{FR\_level}, \text{ in failure per } 10^6 \text{ hours}$$

### III.3. Unit Hour Requirement

A complete Poisson distribution table is needed to compute unit hours. To calculate unit hours with a given number “C” of permitted failures (we are considering 1 permitted failure) we first have to determine the probability of acceptance P<sub>a</sub> by subtracting the FRSP value (0.90 as we have selected a confidence level of 90%) from 1.

Example: P<sub>a</sub> = 1 – 0.90 = 0.10

From Poisson’s table and for a Failure Rate level M, we find for the parameters “C” and P<sub>a</sub> equal respectively to 1 and 0.10 the corresponding “m” value of 3.89; this “m” value in the table is the total of failure rate λ multiplied by the time { test hours }.

$$M = \lambda \times t$$

unit hours = m ÷ λ { 1%/1,000hours as we are working with FR level M }  
 unit hours = 3.89 ÷ 0.00001 = 0.389 million hours (around 45 years)  
 Values for P, R and S levels are found by multiplying the previous level by 10.

### IV. PART FAILURE RATE

The Part Failure Rate as defined by MIL-HDBK- 217F is given by the following formula:

$$\lambda_p = \lambda_b \cdot \pi_{CV} \cdot \pi_Q \cdot \pi_E$$

where:

- λ<sub>b</sub> is the Base Failure Rate;
- π<sub>CV</sub> is the Capacitance Factor;
- π<sub>Q</sub> is Quality Factor;
- π<sub>E</sub> is the Environment Factor.

The Part Failure Rate, considering the capacitor series meet the required FR level, gives the number of failures per 10<sup>6</sup> hours. In MIL-HDBK-217F, the values for all these parameters are given under Capacitors, Fixed, Ceramic, Temperature Compensating and Chip paragraph. The CDR style as described by MIL-PRF-55681F is taken into account and corresponds to Temex Ceramics CHA and CHB sizes.

### IV.1. Quality Factor

The Quality Factor depends on the FR level. If we consider the three FR levels defined previously for Temex Ceramics multilayer capacitors, the given factors are:

Symbol	Product Level	π <sub>Q</sub>
C	non-ER	3.0
M	1.0 % per 1,000 hours	1.0
P	0.1 % per 1,000 hours	0.3

### IV.2. Environment Factor

All part reliability models include the effects of environmental stresses through the Environmental Factor. The descriptions of these environments are shown below and encompass the major areas of equipment use

Environment	Description	π <sub>E</sub>
G <sub>B</sub> : Ground, Benign	Non-mobile, temperature and humidity controlled environments readily accessed to maintenance; includes laboratory instruments and test equipment, medical electronic equipment, business and scientific computer complexes, and missiles and support equipment in ground silos.	1.0
G <sub>F</sub> : Ground, Fixed	Moderately controlled environments such as installation in permanent racks with adequate cooling air and possible installation in unheated buildings; includes permanent installation of air traffic control radar and communications facilities.	2.0
G <sub>M</sub> : Ground, Mobile	Equipment installed on wheeled or tracked vehicles and equipment manually transported; includes tactical missile ground support equipment, mobile communication equipment, tactical fire direction systems, handheld communications equipment, laser designations and range finders.	10.0

### IV.3. Part Failure Rate Calculation

The part failure rate calculated as specified in MIL-HDBK-217F provides a more accurate result than the standard failure rate given by a particular FR level. The two main parameters are the FR level achieved by the standard process – Quality Factor - and the application where the part will be used – Environment Factor. Specific study could be made on request based on customer’s requirements and equipments.

# General Information

## POWER CAPACITOR ENDURANCE TESTING ULTRA-LOW ESR, HIGH RF POWER

### I. FOREWORDS

#### I.1. Concept

Figure 1 shows the general concept. The setup contains a direct digital synthesizer (DDS) that generates an RF signal with a variable frequency. Its signal is amplified by a driver stage followed by a power amplifier stage. The gain of the PA stage is controlled by varying its supply voltage. For that purpose a variable power supply is provided. The directional coupler measures the forward and the reflected power. The latter is a value that describes the quality of the matching condition. The role of the matching network is to match the capacitor to a 50W load. The capacitor under test is mounted on a separate printed circuit board and is encapsulated by a small cabinet. This cabinet isolates the capacitor from the ambient temperature. A temperature sensor is integrated into the cabinet to measure the capacitors temperature.

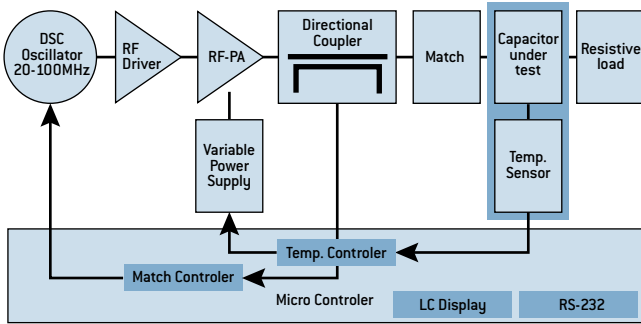

Figure 1

With a microcontroller, there are two control loops realized. The temperature of the capacitor is measured at the beginning of the 5 seconds off time with a temperature sensor. The sensor's signal is used to control the variable power supply which influences the power amplifiers gain and as a consequence, the output power or the current through the capacitor under test.

The ground plane improves the heat spread between the capacitors. This is further supported by a copper bar that is directly pressed on the ground plane of the PC board. On the front side of the copper bar, a NTC is mounted. Tests have shown that this heat coupling is very critical for the overall performance. The NTC is screwed directly and by that the heat coupling is both tight and reliable.

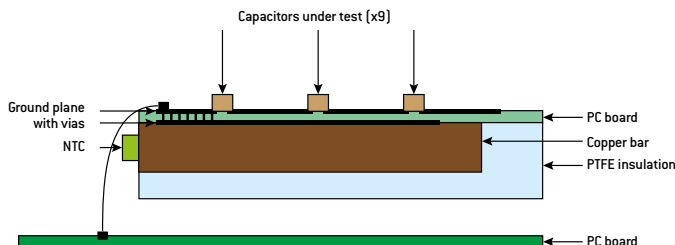

Figure 2

#### I.2. Test Cycle

The complete test cycle is shown in figure 3. The test starts with a tuning procedure at low power. As soon as the matching condition is achieved the RF power is set to the value that is necessary to heat the capacitors. During the ON time, the frequency is continuously adjusted to minimize the reflected power. After 5 seconds ON, the RF is switched off for the next 5 seconds. Then the RF is switched on again. Because the capacitors have cooled down during the OFF time, the test generator needs to re-tune. The re-tune procedure takes 500ms. After that, the RF is ON for the next 5 seconds. That way a complete cycle takes 10 seconds.

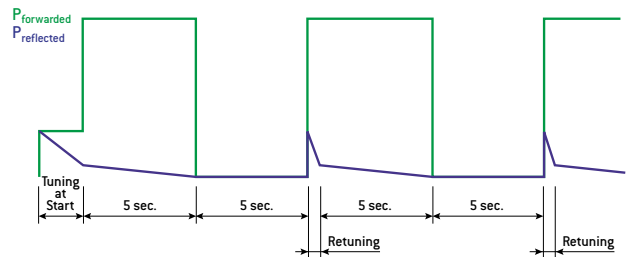

Figure 3

The following conditions have been used:

- HiQ multilayer ceramic capacitors operated at 27MHz;
- 2 complete test sets are done, one for B size (1111) and another for X size (2225);
- a complete test set represents 1 million cycles (4 months of continuous RF power).

#### I.3. Data Acquisition

The test generator measures continuously: the frequency, the forward power, the reflected power and the three temperatures. The test generator stores these values always at the end of the 5 seconds ON time. The remote computer gathers the data at least once each cycle and writes these records to a log file. Each file collects the record of one day and is automatically sent by email once a day.

# General Information

## II. RESULTS

All the tests have been performed by an external independent company named Barthel HF Technik located in Aachen, Germany.

### II.1. HiQ Capacitors – B Size [1111] – Solderable Nickel Barrier

The CHB series RF/Microwave capacitors offer both extended operating temperatures up to 175°C and extended voltages up to 1500 V<sub>DC</sub>. These components are based on our well-known P100 HiQ dielectric, a low loss material, which is ESA and MIL qualified - ITAR free.

On May the 9th 2011, the test set was completed without any problem to report.

## III. CONCLUSIONS

These tests have shown the reliability of Temex-Ceramics capacitors in operation. Each of the HiQ capacitors under test has been exposed during 4 months to their maximum RF power signal rating, heated up to 125°C continuously and without any failure or event to report.

This endurance test, along with the European Space Agency qualification (see ESA.pdf on our website), the regular life test performed on standard production lots (see Reliability\_Data.pdf) and the MIL class R rating (see MIL.pdf) highlight, the high quality and reliability associated with Temex Ceramics capacitors.



### II.2. HiQ Capacitors – X Size [2225] – Non Magnetic Solderable Barrier

The CLX series High RF Current/Voltage capacitors offer both ultra stability over temperature and extended voltages up to 3 600 V<sub>DC</sub>. These components are based on our well-known NPO HiQ dielectric, a low loss and ultra stable material, which is MR<sub>certified</sub><sup>®</sup> and MIL qualified - ITAR free.

On November the 9th 2011, the test set was completed without any problem to report.



# General Information

## IV. APPENDIX

The capacitance of the capacitor under test may vary during the temperature ramp up time. Additionally it may vary if there is a beginning of destruction process. If the frequency was kept constant, the RF power coupled into the capacitor under test will decrease. Hence the temperature control loop will increase the RF power.

This may lead to a situation where the temperature decreases when the RF power cannot be increased any more. In order to cope with this, there is a second control loop that varies the frequency in order to minimize the reflected power. So the RF power amplifier stage will always be able to deliver the necessary power to keep the temperature constant.

As PC board, a ceramic material from Rogers is used, the R04350 material. Comparing to the standard FR4 material the ceramic board has the following advantages: improved heat conductivity; improved heat resistance and improved electrical strength.

Due to the improved electrical strength, it was possible to have a ground plane on the bottom side of the board. The coupler bar rests on a PTFE insulation. It was meant to be a heat insulation. However, during pre-tests, it became apparent that the PTFE material spreads the heat more than expected. In order to improve the heat insulation towards ground and the ambient air, the complete setup is now surrounded by a layer of glass wool.

All these efforts led to the following results: the temperature difference between the RF on time and the RF off time is less than 10°C and a total RF power of approximately 35 Watts is sufficient to heat the capacitors to 125°C. The capacitors under test are soldered with a non lead solder, Sn95Ag4Cu1 which has an extended temperature range also. Figure 4 shows the test setup.

Both control loops are realized by a micro controller. Additionally, the micro controller provides an RS-232 interface to set some configuration values. A LC display shows warning messages also and some status information like temperature, RF power, etc.

The test generator works completely self sustained. It controls the temperature, RF power, frequency and all other parameters. The test generator takes also care that it remains itself within safe limits like maximum cool plate temperature, maximum forward power, maximum reflected power, frequency within a given bandwidth, etc. The test generator is connected to a remote computer.

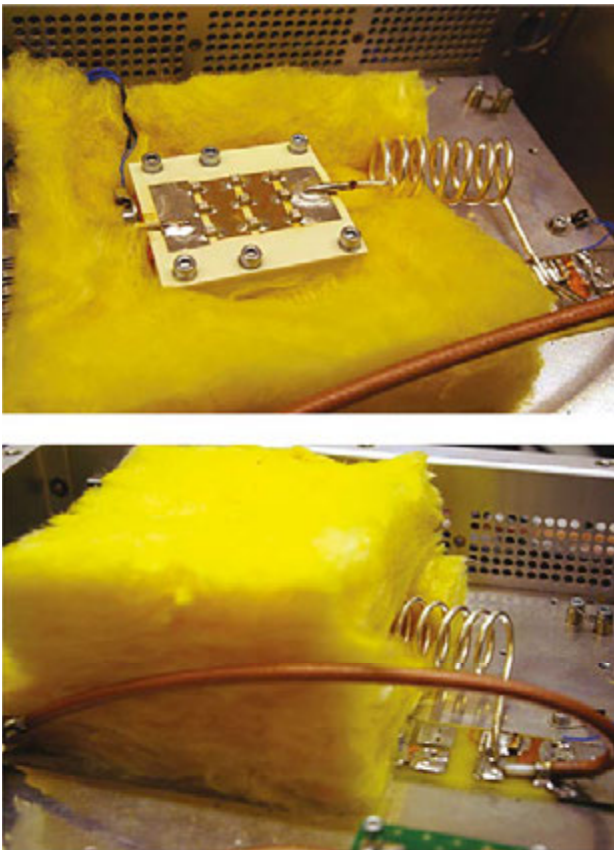

Figure 4





## FEATURES

- Low ESR, Ultra High-Q, High Self-Resonant Frequencies
- RF & Microwave capacitors
- Voltage range: 50V - 1,500V
- Capacitance range: 0.1pF - 1,000pF
- Operating temperature up to 125°C\*
- Porcelain Capacitors P100
- Laser Marked (optional)
- RoHS compliant

## APPLICATIONS

- Cellular Base Station Amplifiers
- Industrial
- Medical (MRI)
- Scientific

## CIRCUIT APPLICATIONS

- DC to RF Conversion
- Matching Networks
- Tuning, Coupling and DC Blocking

## PHYSICAL CHARACTERISTICS

- Chip capacitors for surface mounting with copper (non magnetic) or nickel barrier and tinning
- Ribbon leads for surface mounting

## ELECTRICAL AND ENVIRONMENTAL SPECIFICATIONS

Electrical specifications	
Parameter	Value
Capacitance	0.1pF - 1,000pF
Tolerances	A, B, C, D below 10pF F, G, J, K above 10pF
Working voltage (WVDC)	See capacitance range chart
Temperature coefficient	(100 ± 30) ppm/°C, -55°C to +125°C
Insulation Resistance	10 <sup>6</sup> MΩ min.
Dielectric Withstanding (test voltage applied for 5 seconds)	2.5 x WVDC for WVDC ≤ 500V 1.8 x WVDC for extended range values ≥ 820pF 1.5 x WVDC for WVDC > 500V
Aging	none
Piezo Effect	none

Environmental specifications	
Parameter	Value
Life Test	2,000 hours, +125°C at 2 x WVDC (standard WVDC range) And CHB up to 100pF: 1,000 hours, 175°C at 500V
Moisture Resistance Test 1	240 hours, 85% relative humidity at 85°C (ESA/SCC n°3009)
Moisture Resistance Test 2	56 days, 93% relative humidity at 40°C 0V, 5V, WVDC

NB: The temperature range for the CHB up to 100pF is upgraded from +125°C to +175°C.

## HOW TO ORDER

152	CH	B	100	J	S	1	L	E	-RoHS
Voltage code	Dielectric	Size code	Capacitance code	Tolerance code	Termination code	Ribbon code	Marking code	Tape and reel	
500 = 50V 101 = 100V 201 = 200V 251 = 250V 301 = 300V 501 = 500V 601 = 600V 102 = 1,000V 152 = 1,500V	CH = (100 ± 30) ppm/°C	A = 0505 B = 1111	Please refer to capacitance code given in capacitance range chart	A = ±0.05pF B = ±0.1pF C = ±0.25pF D = ±0.5pF F = ±1% G = ±2% J = ±5% K = ±10% See note 1	S = Standard: tin-plated nickel  C = Non-magnetic: tin-plated copper  See note 2	-: no lead or ribbon <u>Available on size 1111:</u> 1 = Micro-strip ribbons 6 = Radial leads 0.1pF (0R1) non available with these terminations. See note 3	-: no marking  L = laser marking	-: no tape and reel  E = horizontal orientation X = verticale orientation CHA: 3,000 components per reel CHB: 1,000 components per reel	The RoHS tag is not part of the reference  Tag added at the end of P/N for information
Please refer to voltage given in capacitance range chart									

Note 1: For capacitance values less than 10pF, tolerances B, C and D available. Tolerance code A available for: A case for capacitance values of 0.1pF - 4.7pF. B case for capacitance values of 0.1pF - 3.3pF. For capacitance values of 10pF or higher, tolerances F, G, J and K available.

Note 2: All terminations are backward compatible and lead-free. The non-magnetic terminations are all Magnetism-free Rated.

Note 3: when coding ribbons for the description of the part, the termination has to be mentioned for MR certified types to ensure that only non-magnetic materials are used.

Examples: 501 CHB 470 J1L any termination material could be used. 501 CHB 470 JC1L only non-magnetic termination materials could be used.

Please consult us for specific requirements.

# CH Series

Classic HiQ

## TYPICAL PERFORMANCE DATA CHA (0505 SIZE):

S-Parameters available with ABC software.

### ESR VERSUS FREQUENCY

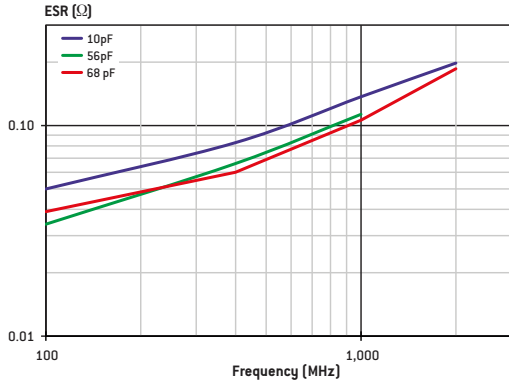

### CURRENT RATING VERSUS CAPACITANCE

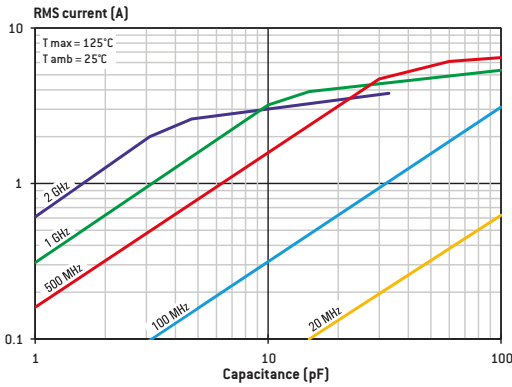

### Q FACTOR VERSUS FREQUENCY

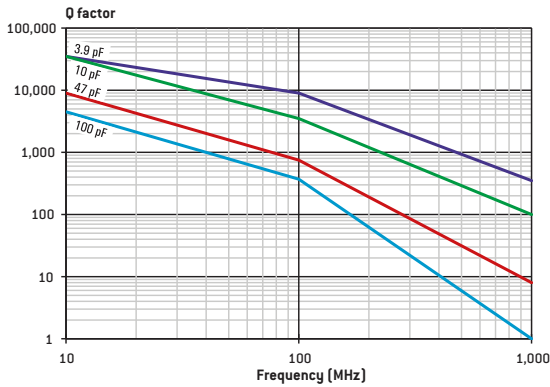

### SERIES RESONANCE FREQUENCY VERSUS CAPACITANCE

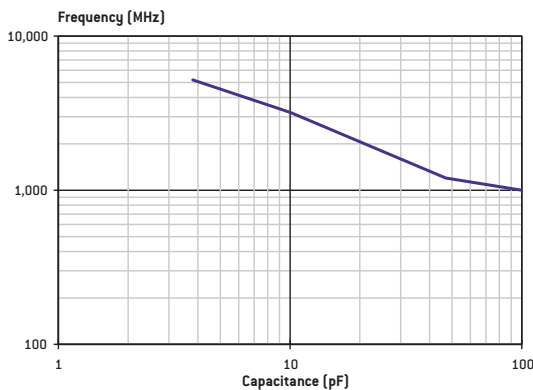

## TYPICAL PERFORMANCE DATA CHB (SIZE 1111):

S-Parameters available with ABC software.

### ESR VERSUS FREQUENCY

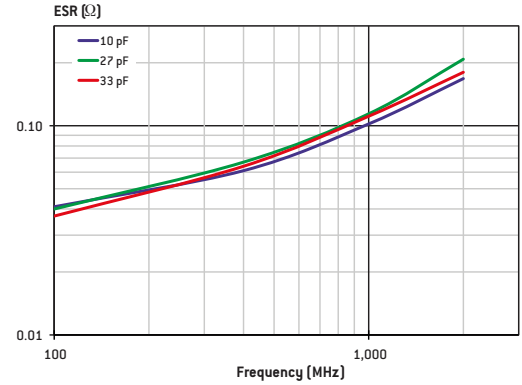

### CURRENT RATING VERSUS CAPACITANCE

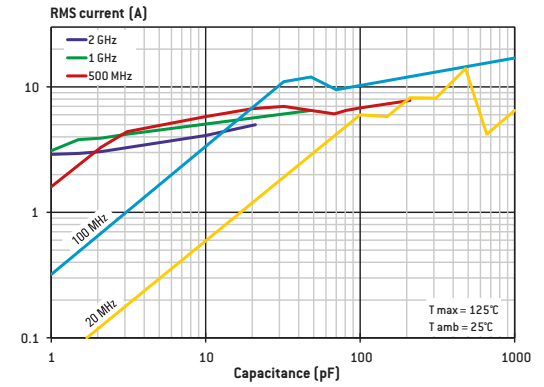

### Q FACTOR VERSUS FREQUENCY

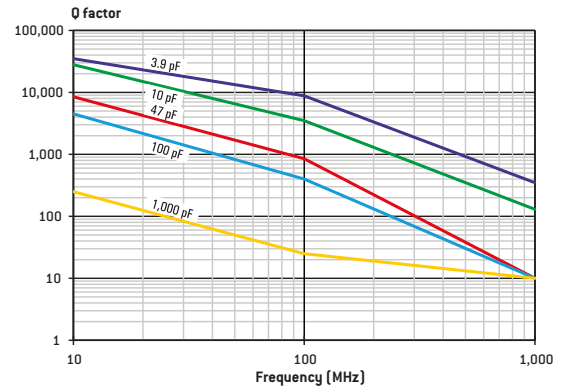

### SERIES RESONANCE FREQUENCY VERSUS CAPACITANCE

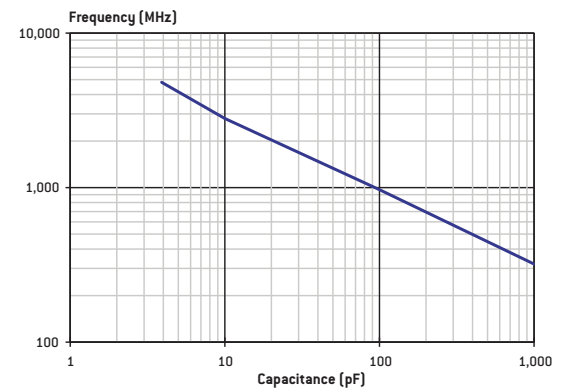

DIMENSIONS in inches (mm)

Chips

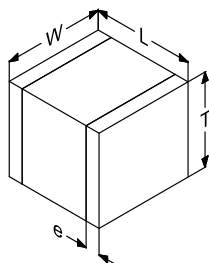

Micro-strip ribbon leads (Type 1)

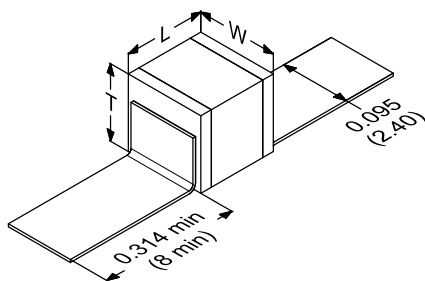

Radial leads (Type 6)

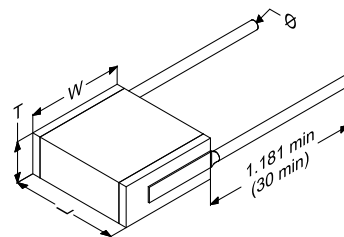

STANDARD RATINGS

Size		0505	1111	
Size code		A	B	
Dimensions inches (mm)	L	0.055 ± 0.01 (1.4 ± 0.25)	0.11 ± 0.016 (2.8 ± 0.4)	
	W	0.055 ± 0.01 (1.4 ± 0.25)	0.11 ± 0.016 (2.8 ± 0.4)	
	T	0.056 max (1.4 max)	0.103 max (2.6 max)	
	e	0.01 ± 0.006 (0.25 ± 0.15)	0.016 ± 0.01 (0.4 ± 0.25)	
Value [pF]	Cap. Code	Standard	Standard	Extended
0.1	OR1	250V	500V	1,500V
0.2	OR2			
0.3	OR3			
0.4	OR4			
0.5	OR5			
0.6	OR6			
0.7	OR7			
0.8	OR8			
0.9	OR9			
1.0	1R0			
1.1	1R1			
1.2	1R2			
1.3	1R3			
1.4	1R4			
1.5	1R5			
1.6	1R6			
1.7	1R7			
1.8	1R8			
1.9	1R9			
2.0	2R0			
2.1	2R1			
2.2	2R2			
2.4	2R4			
2.7	2R7			
3.0	3R0			
3.3	3R3			
3.6	3R6			
3.9	3R9			
4.3	4R3			
4.7	4R7			
5.1	5R1			
5.6	5R6			
6.2	6R2			
6.8	6R8			
7.5	7R5			
8.2	8R2			
9.1	9R1			
10	100			
11	110			
12	120			
13	130			
15	150			
16	160			
18	180			
20	200			
22	220			
24	240			
27	270			
30	300			
33	330			
36	360			
39	390			
43	430			
47	470			

Size		0505	1111		
Size code		A	B		
Dimensions inches (mm)	L	0.055 ± 0.01 (1.4 ± 0.25)	0.11 ± 0.016 (2.8 ± 0.4)		
	W	0.055 ± 0.01 (1.4 ± 0.25)	0.11 ± 0.016 (2.8 ± 0.4)		
	T	0.056 max (1.4 max)	0.103 max (2.6 max)		
	e	0.01 ± 0.006 (0.25 ± 0.15)	0.016 ± 0.01 (0.4 ± 0.25)		
Value [pF]	Cap. Code	Standard	Standard	Extended	
51	510	200V	500V	1,500V	
56	560				
62	620				
68	680				
75	750				
82	820				
91	910				
100	101				
110	111				
120	121				
130	131	300V	1,000V		
150	151				
160	161				
180	181				
200	201				
220	221				
240	241				
270	271	200V	600V		
300	301				
330	331				
360	361				
390	391				
430	431				
470	471				
510	511			100V	300V
560	561				
620	621				
680	681				
750	751				
820	821	50V	300V		
910	911				
1,000	102				

Special values, tolerances, higher WVDC and matching available, please consult factory.

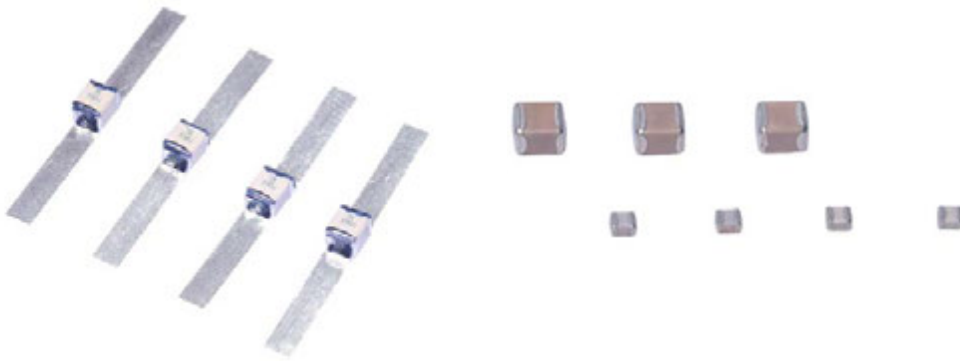

## FEATURES

- Lowest ESR in class, High Self-Resonant Frequencies, RF capacitors
- Highest working voltage in class: 1,500V
- Standard EIA sizes: 0402 - 1111
- Capacitance range: 0.2pF - 1,000pF
- NP0, RoHS & REACH compliant
- Operating temperature up to 125° C\*
- Laser Marked (optional)

## APPLICATIONS

- Cellular Base Station Equipments
- Broadband Wireless Service
- Point to Point / Multipoint Radios
- RF Generators (NMR...)

## CIRCUIT APPLICATIONS

- Filter Networks
- Matching Networks
- Tuning, Coupling and DC Blocking

## PHYSICAL CHARACTERISTICS

- Chip capacitors for surface mounting with:
  - Copper barrier and tinning or Silver/Palladium (non magnetic)
  - Nickel barrier and tinning
- Ribbon leads for surface mounting

## ELECTRICAL AND ENVIRONMENTAL SPECIFICATIONS

Electrical specifications	
Parameter	Value
Capacitance	0.2pF - 1,000pF
Tolerances	A, B, C, D below 10pF F, G, J, K above 10pF
Working voltage (WVDC)	See capacitance range chart
Temperature coefficient	0 ± 30ppm/°C, -55°C to +125°C For SHF and SHS: 0 ± 30ppm/°C, -55°C to +150°C
Insulation Resistance	10 <sup>5</sup> MΩ min.
Dielectric Withstanding (test voltage applied for 5 seconds)	2.5 x WVDC for WVDC ≤ 500V 1.8 x WVDC for extended range values ≥ 820pF 1.5 x WVDC for WVDC > 500V
Aging	none
Piezo Effect	none

Environmental specifications	
Parameter	Value
Life Test	2,000 hours, +125°C at 2 x WVDC (standard WVDC range) And SHB up to 100pF: 1,000 hours, 175°C at 500V
Moisture Resistance Test 1	240 hours, 85% relative humidity at 85°C (ESA/SCC n°3009)
Moisture Resistance Test 2	56 days, 93% relative humidity at 40°C 0V, 5V, WVDC

\* The temperature range for the SHB up to 100pF is upgraded from +125°C to +175°C.  
The temperature withstanding for SHF and SHS is 150°C for the whole capacitance range.

## HOW TO ORDER

501	SH	B	100	J	S	-	L	E	-RoHS
Voltage code	Dielectric	Size code	Capacitance code	Tolerance code	Termination code	Ribbon code	Marking code	Tape and reel	
<b>250</b> = 25V <b>500</b> = 50V <b>101</b> = 100V <b>201</b> = 200V <b>251</b> = 250V <b>301</b> = 300V <b>501</b> = 500V <b>601</b> = 600V <b>102</b> = 1,000V <b>152</b> = 1,500V  Please refer to voltage given in capacitance range chart	<b>SH</b> = NP0: (0±30) ppm/°C	<b>L</b> = 0402 <b>S</b> = 0603 <b>A</b> = 0505 <b>F</b> = 0805 <b>N</b> = 1206 <b>T</b> = 1210 <b>B</b> = 1111	Please refer to Cap. Code given in capacitance range chart.	<b>A</b> = ± 0.05pF <b>B</b> = ± 0.1pF <b>C</b> = ± 0.25pF <b>D</b> = ± 0.5pF <b>F</b> = ± 1% <b>G</b> = ± 2% <b>J</b> = ± 5% <b>K</b> = ± 10%  See note 1	<b>S</b> = Standard: tin-plated nickel <u>Available on sizes 0505, 0603 and 1111:</u> <b>C</b> = Non-magnetic: tin-plated copper <u>Available on sizes 0505, 0805 [from 0.5pF to 150pF, consult us for higher cap. value], 1206 and 1210:</u> <b>A</b> = Non-magnetic: silver/palladium See note 2	-: no lead or ribbon  <u>Available on size 1111:</u> <b>1</b> = Micro-strip ribbons <b>6</b> = Radial Wires  See note 3	-: no marking  <u>Available on sizes 0505 and 1111:</u> <b>L</b> = laser marking	-: no tape and reel  <b>E</b> = Tape and reel packaging Number of components per reel: SHL: 10,000 SHA: 3,000 SHS: 4,000 SHF: 4,000 SHN: 3,000 SHT: 3,000 SHB: 1,000	The RoHS tag is not part of the reference  Tag added at the end of P/N for information

Note 1: For capacitance values less than 10pF, tolerances B, C and D available. Tolerance code A available for: L case for capacitance values of 0.2pF - 1.9pF. A case for capacitance values of 0.2pF - 4.7pF. S case for capacitance values of 0.2pF - 9.1pF. F case for capacitance values of 0.3pF - 2.2pF. N case for capacitance values of 0.5pF - 1.8pF. B case for capacitance values of 0.2pF - 3.3pF. For capacitance values of 10pF or higher, tolerances F, G, J and K available.

Note 2: All terminations are backward compatible and lead-free. The non-magnetic terminations are all Magnetism-free Rated.

Note 3: When coding ribbons for the description of the part, the termination has to be mentioned for MRcertified types to ensure that only non-magnetic materials are used.

Examples: 501 SHB 470 J1L any termination material could be used. 501 SHB 470 J1L only non-magnetic termination materials could be used. Please consult us for specific requirements.

**TYPICAL PERFORMANCE DATA**

S-Parameters available with ABC software.

**SHA (SIZE 0505): TYPICAL ESR VERSUS FREQUENCY**

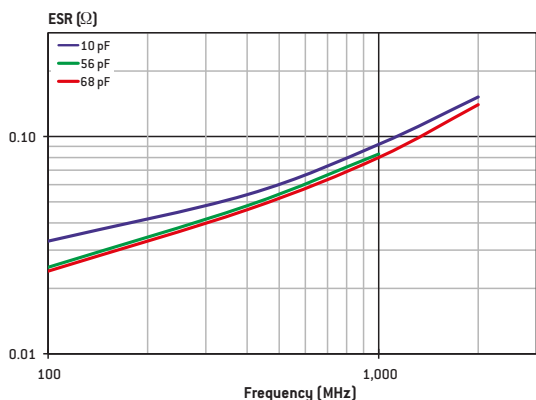

**SHB (SIZE 1111): TYPICAL ESR VERSUS FREQUENCY**

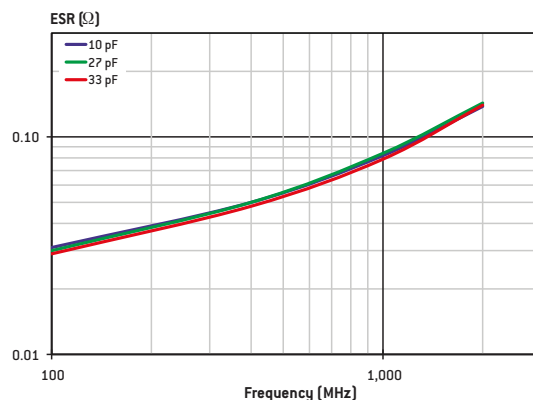

**SHS (SIZE 0603): TYPICAL ESR VERSUS FREQUENCY**

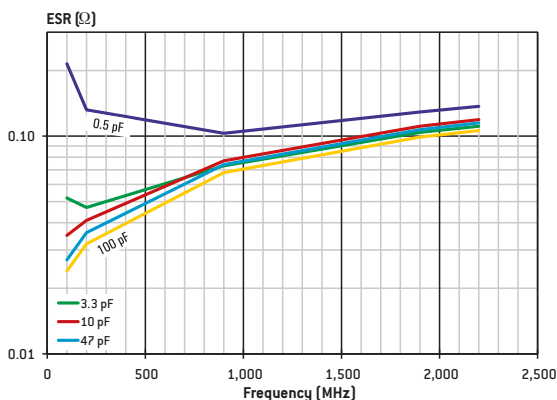

**SHS (SIZE 0603): TYPICAL Q FACTOR VERSUS FREQUENCY**

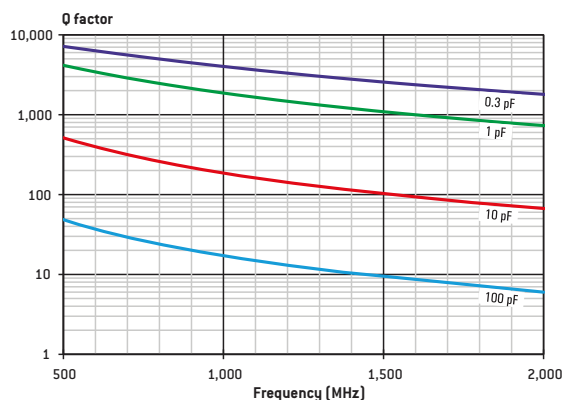

**SHF (SIZE 0805): TYPICAL ESR VERSUS FREQUENCY**

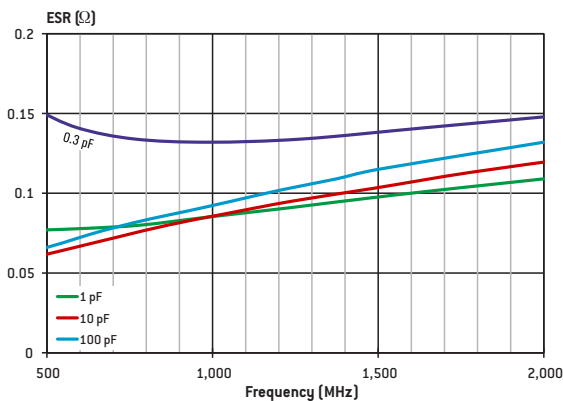

**SHF (SIZE 0805): TYPICAL Q FACTOR VERSUS FREQUENCY**

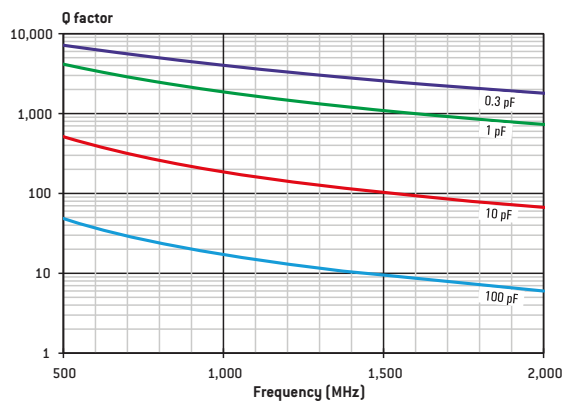

**DIMENSIONS in inches (mm)**

**Chips**

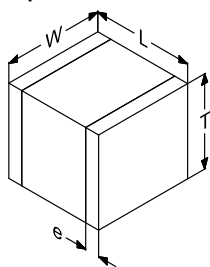

**Micro-strip ribbon leads (Type 1)**

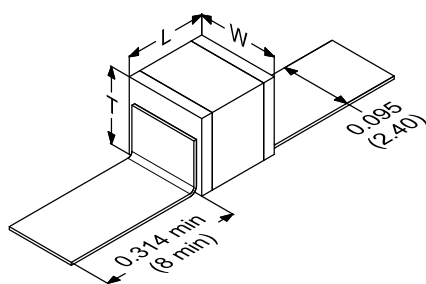

**Radial leads: available on all sizes (Type 6)**

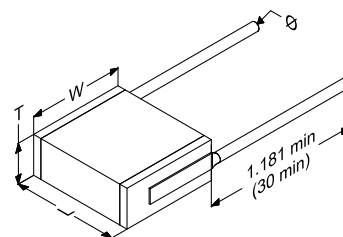

## STANDARD RATINGS

Size		0402	0603	0505	0805	1206	1210	1111									
Size code		L	S	A	F	N	T	B									
Dimensions inches (mm)	L	0.039 ± 0.006 (1 ± 0.15)	0.063 ± 0.01 (1.6 ± 0.25)	0.055 ± 0.01 (1.4 ± 0.25)	0.08 ± 0.01 (2.03 ± 0.25)	0.125 ± 0.01 (3.18 ± 0.25)	0.125 ± 0.01 (3.18 ± 0.25)	0.110 ± 0.016 (2.80 ± 0.40)									
	W	0.02 ± 0.006 (0.5 ± 0.15)	0.032 ± 0.01 (0.8 ± 0.25)	0.055 ± 0.01 (1.4 ± 0.25)	0.05 ± 0.01 (1.27 ± 0.25)	0.062 ± 0.01 (1.58 ± 0.25)	0.095 ± 0.01 (2.41 ± 0.25)	0.110 ± 0.016 (2.80 ± 0.40)									
	T	0.02 max (0.51 max)	0.036 max (0.9 max)	0.056 max (1.4 max)	0.05 max (1.27 max)	0.05 max (1.27 max)	0.06 max (1.52 max)	0.103 max (2.60 max)									
	e	0.01 ± 0.006 (0.25 ± 0.15)	0.014 ± 0.008 (0.35 ± 0.2)	0.01 ± 0.006 (0.25 ± 0.15)	0.02 ± 0.012 (0.5 ± 0.3)	0.02 ± 0.01 (0.5 ± 0.25)	0.02 ± 0.01 (0.5 ± 0.25)	0.016 ± 0.010 (0.40 ± 0.25)									
Value [pF]	Cap. Code	Standard	Standard	Standard	Standard	Standard	Standard	Standard	Extended								
0.2	OR2	50 - 250V															
0.3	OR3																
0.4	OR4																
0.5	OR5																
0.6	OR6																
0.7	OR7																
0.8	OR8																
0.9	OR9																
1.0	1R0																
1.1	1R1																
1.2	1R2																
1.3	1R3																
1.4	1R4																
1.5	1R5																
1.6	1R6																
1.7	1R7																
1.8	1R8																
1.9	1R9																
2.0	2R0	250V		250V		500V											
2.1	2R1																
2.2	2R2																
2.4	2R4																
2.7	2R7																
3.0	3R0																
3.3	3R3																
3.6	3R6																
3.9	3R9																
4.3	4R3																
4.7	4R7																
5.1	5R1																
5.6	5R6																
6.2	6R2																
6.8	6R8																
7.5	7R5																
8.2	8R2																
9.1	9R1																
10	100	50 - 200V															
11	110																
12	120																
15	150																
16	160																
18	180																
20	200																
22	220																
24	240																
27	270																
30	300									25 - 50V							
33	330																
36	360																
39	390																
43	430																
47	470																
51	510																
56	560																
62	620																
68	680																
75	750																
82	820																
91	910																
100	101																
110	111																
120	121																
130	131																
150	151																
160	161																
180	181																
200	201																
220	221																
240	241																
270	271																
300	301																
330	331																
360	361																
390	391																
430	431																
470	471																
510	511																
560	561																
620	621																
680	681																
750	751																
820	821																
910	911																
1,000	102																

Special values, tolerances, higher WVDC and matching available, please consult factory.

# Reverse Geometry

# SHR / SHD Series



## FEATURES

- Reverse-Geometry MLCC providing Ultra low ESL and very High Self Resonant Frequencies
- High power dissipation
- Lowest ESR in class, RF & Microwave capacitors
- Working voltage: 500V
- Sizes: 0709 and 0711
- Capacitance range: 0.5pF - 100pF
- NPO, RoHS compliant
- Operating temperature up to 175°C
- Laser Marked (optional)

## APPLICATIONS

- Cellular Base Station Equipments
- Broadband Wireless Service
- Point to Point / Multipoint Radios
- Broadcasting Equipment

## CIRCUIT APPLICATIONS

- Impedance Matching
- Bypass, Feedback
- Tuning, Coupling and DC Blocking

## PHYSICAL CHARACTERISTICS

Chip capacitors for surface mounting with Nickel barrier and tinning.

## ELECTRICAL AND ENVIRONMENTAL SPECIFICATIONS

Electrical specifications	
Parameter	Value
Capacitance	0.5pF - 100pF
Tolerances	A, B, C, D below 10pF F, G, J, K above 10pF
Working voltage (WVDC)	500V
Temperature coefficient	NPO: (0 ± 30) ppm/°C, -55°C to +175°C
Insulation Resistance	10 <sup>5</sup> MΩ min.
Dielectric Withstanding (test voltage applied for 5 seconds)	1,250V
Aging	none
Piezo Effect	none

Environmental specifications	
Parameter	Value
Life Test	2,000 hours, +125°C at 1,000V 1,000 hours, +175°C at 500V
Moisture Resistance Test 1	240 hours, 85% relative humidity at 85°C (ESA/SCC n°3009)
Moisture Resistance Test 2	56 days, 93% relative humidity at 40°C 0V, 5V, WVDC

## HOW TO ORDER

501	SH	R	100	J	S	L	E	-RoHS
Voltage code	Dielectric	Size code	Capacitance code	Tolerance code	Termination code	Marking code	Tape and reel	
501 = 500V	SH = NPO: (0 ± 30) ppm/°C	R = 0709 D = 0711	Please refer to Cap. Code given in capacitance range chart	A = ± 0.05pF B = ± 0.1pF C = ± 0.25pF D = ± 0.5pF F = ± 1% G = ± 2% J = ± 5% K = ± 10% See note	S = Standard: tin-plated nickel  All terminations are backward compatible and lead-free	-: no marking  L = laser marking	-. no tape and reel E = Tape and reel packaging Number of components per reel: 1,000.	The RoHS tag is not part of the reference  Tag added at the end of P/N for information

Note: For capacitance values less than 3.3pF, tolerances A, B, C and D are available. For capacitance values less than 10pF, tolerances B, C and D are available. For capacitance values of 10pF or higher, tolerances F, G, J and K are available. Please consult us for specific requirements.

# SHR / SHD Series

Reverse Geometry

## DIMENSIONS in inches (mm)

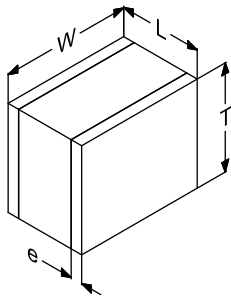

## STANDARD RATINGS

Size		0709	0711
Size code		R	D
Dimensions inches (mm)	L	0.07 ± 0.015 (1.78 ± 0.38)	0.07 ± 0.015 (1.78 ± 0.38)
	W	0.09 ± 0.01 (2.29 ± 0.25)	0.105 ± 0.01 (2.67 ± 0.25)
	T	0.106 max (2.67 max)	0.09 max (2.29 max)
	e	0.01 +0.008/-0.006 (0.25 +0.2/-0.15)	0.01 +0.008/-0.006 (0.25 +0.2/-0.15)
Value (pF)	Cap. Code	Standard	Standard
0.5	OR5		
0.6	OR6		
0.7	OR7		
0.8	OR8		
0.9	OR9		
1.0	1R0		
1.1	1R1		
1.2	1R2		
1.3	1R3		
1.4	1R4		
1.5	1R5		
1.6	1R6		
1.7	1R7		
1.8	1R8		
1.9	1R9		
2.0	2R0		
2.1	2R1		
2.2	2R2		
2.4	2R4		
2.7	2R7		
3.0	3R0		
3.3	3R3		
3.6	3R6		
3.9	3R9		
4.3	4R3		
4.7	4R7		
5.1	5R1		
5.6	5R6		
6.2	6R2	500V	500V
6.8	6R8		
7.5	7R5		
8.2	8R2		
9.1	9R1		
10	100		
11	110		
12	120		
15	150		
16	160		
18	180		
20	200		
22	220		
24	240		
27	270		
30	300		
33	330		
36	360		
39	390		
43	430		
47	470		
51	510		
56	560		
62	620		
68	680		
75	750		
82	820		
91	910		
100	101		

### TYPICAL ESR VERSUS FREQUENCY

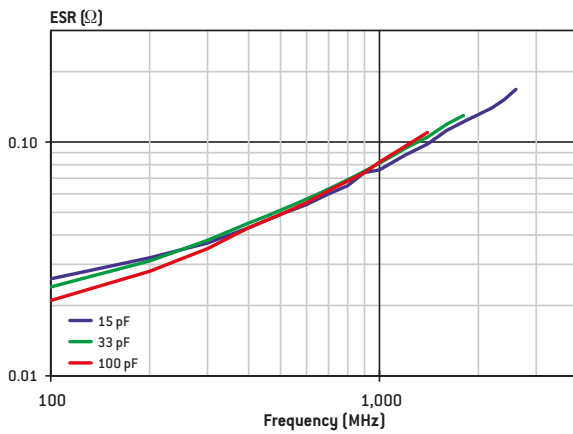

### TYPICAL SERIES RESONANT FREQUENCY VERSUS CAPACITANCE

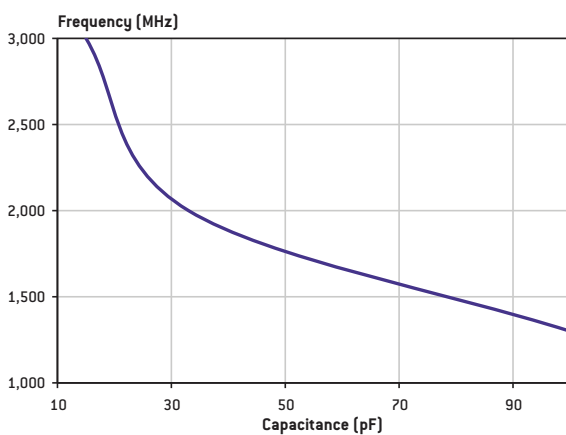



# High Self Resonant Frequency

# NHB Series



## FEATURES

- High RF power MLCC
- Very high self resonant frequencies, lowest ESR in class, RF & Microwave capacitors
- Working voltage: 500V
- Size: 1111
- Capacitance range: 0.3pF - 100pF
- NPO, RoHS compliant
- Operating temperature up to 175°C
- Laser Marked (optional)

## APPLICATIONS

- Cellular Base Station Equipments
- Broadband Wireless Service
- Point to Point / Multipoint Radios
- Broadcasting Equipment

## CIRCUIT APPLICATIONS

- Impedance Matching
- Bypass, Feedback
- Tuning, Coupling and DC Blocking

## PHYSICAL CHARACTERISTICS

Chip capacitors for surface mounting with Nickel barrier and tinning.

## ELECTRICAL AND ENVIRONMENTAL SPECIFICATIONS

Electrical specifications	
Parameter	Value
Capacitance	0.3pF - 100pF
Tolerances	A, B, C, D below 10pF F, G, J, K above 10pF
Working voltage (WVDC)	500V
Temperature coefficient	NPO: (0 ± 30) ppm/°C, -55°C to +175°C
Insulation Resistance	10 <sup>5</sup> MΩ min.
Dielectric Withstanding (test voltage applied for 5 seconds)	1,250V
Aging	none
Piezo Effect	none

Environmental specifications	
Parameter	Value
Life Test	1,000 hours, +175°C at 500V 2,000 hours, +125°C at 1,000V
Moisture Resistance Test 1	240 hours, 85% relative humidity at 85°C (ESA/SCC n°3009)
Moisture Resistance Test 2	56 days, 93% relative humidity at 40°C 0V, 5V, WVDC

## HOW TO ORDER

501	NH	B	100	J	S	L	E	-RoHS
Voltage code	Dielectric	Size code	Capacitance code	Tolerance code	Termination code	Marking code	Tape and reel	
501 = 500V	NH = NPO: (0 ± 30) ppm/°C	B = 1111	Please refer to Cap. Code given in capacitance range chart	A = ± 0.05pF B = ± 0.1pF C = ± 0.25pF D = ± 0.5pF F = ± 1% G = ± 2% J = ± 5% K = ± 10% See note	S = Standard: tin-plated nickel  All terminations are backward compatible and lead-free	-: no marking  L = laser marking	-: no tape and reel  E = Tape and reel packaging Number of components per reel: 1,000.	The RoHS tag is not part of the reference  Tag added at the end of P/N for information

Note: For capacitance values less than 3.3pF, tolerances A, B, C and D are available. For capacitance values less than 10pF, tolerances B, C and D are available. For capacitance values of 10pF or higher, tolerances F, G, J and K are available. Please consult us for specific requirements.

# NHB Series

High Self Resonant Frequency

## DIMENSIONS in inches (mm)

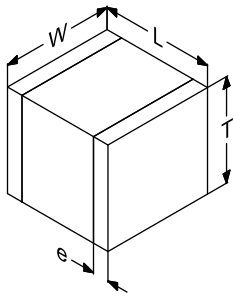

### TYPICAL ESR VERSUS FREQUENCY

Capacitance value = 33pF

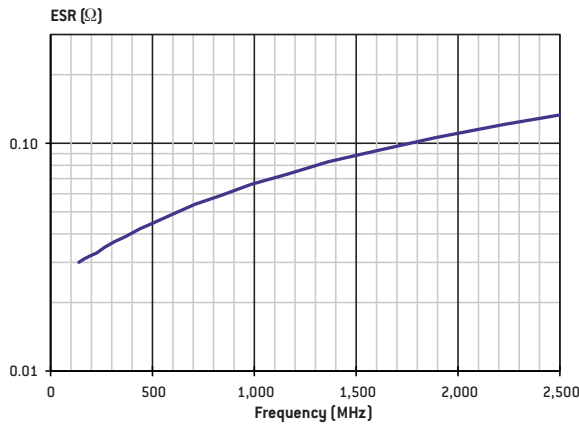

## STANDARD RATINGS

Size		1111
Size code		B
Dimensions inches (mm)	L	0.11 ± 0.016 (2.8 ± 0.4)
	W	0.11 ± 0.016 (2.8 ± 0.4)
	T	0.103 max (2.6 max)
	e	0.016 ± 0.01 (0.4 ± 0.25)
Value (pF)	Cap. Code	Standard
0.3	OR3	
0.4	OR4	
0.5	OR5	
0.6	OR6	
0.7	OR7	
0.8	OR8	
0.9	OR9	
1.0	1R0	
1.1	1R1	
1.2	1R2	
1.3	1R3	
1.4	1R4	
1.5	1R5	
1.6	1R6	
1.7	1R7	
1.8	1R8	
1.9	1R9	
2.0	2R0	
2.1	2R1	
2.2	2R2	
2.4	2R4	
2.7	2R7	
3.0	3R0	
3.3	3R3	
3.6	3R6	
3.9	3R9	
4.3	4R3	
4.7	4R7	
5.1	5R1	
5.6	5R6	
6.2	6R2	
6.8	6R8	
7.5	7R5	
8.2	8R2	
9.1	9R1	
10	100	
11	110	
12	120	
15	150	
16	160	
18	180	
20	200	
22	220	
24	240	
27	270	
30	300	
33	330	
36	360	
39	390	
43	430	
47	470	
51	510	
56	560	
62	620	
68	680	
75	750	
82	820	
91	910	
100	101	

500V

Special values, tolerances, higher WVDC and matching available, please consult factory.

# High Power

# CP Series



## FEATURES

- Low ESR/ESL, RF power capacitors
- Porcelain capacitors P100, RoHS compliant
- Excellent characteristics in current, voltage and power with high Q factor
- Working voltage: 200V - 7,000V
- Sizes: 2225 and 4040
- Capacitance range: 1pF - 10,000pF
- Laser Marked (optional)

## APPLICATIONS

- RF Power Amplifiers
- Industrial (Plasma Chamber)
- Medical (MRI Coils)

## CIRCUIT APPLICATIONS

- DC Blocking
- Matching Networks
- Tuning and Coupling

## PHYSICAL CHARACTERISTICS

- Chip capacitors for surface mounting with Nickel barrier and tinning or Copper barrier and tinning (non magnetic)
- Ribbon leads for surface mounting, axial or radial leads for through-hole circuits

## ELECTRICAL AND ENVIRONMENTAL SPECIFICATIONS

Electrical specifications	
Parameter	Value
Capacitance	1pF - 10,000pF
Tolerances	B, C, D below 10pF F, G, J, K above 10pF
Working voltage (WVDC)	See capacitance range chart
Temperature coefficient	(100 ± 30) ppm/°C, -55°C to +125°C
Insulation Resistance	10 <sup>5</sup> MΩ min at 25°C at rated WVDC 10 <sup>4</sup> MΩ min at 125°C at rated WVDC
Dielectric Withstanding (test voltage applied for 5 seconds)	2 x WVDC for WVDC ≤ 500V 1.5 x WVDC for 500V < WVDC ≤ 2,500V 1.3 x WVDC for WVDC > 2,500V
Aging	none
Piezo Effect	none

Environmental specifications	
Parameter	Value
Life Test	2,000 hours, +125°C at 1.5 x WVDC (WVDC ≤ 500V) at 1.3 x WVDC (500V < WVDC < 1,250V) at 1 x WVDC (1,250V ≤ WVDC)
Moisture Resistance Test 1	240 hours, 85% relative humidity at 85°C (ESA/SCC n°3009)
Moisture Resistance Test 2	56 days, 93% relative humidity at 40°C 0V, 5V, WVDC or 500V whichever is less

## HOW TO ORDER

362	CP	X	100	G	C	1	-	L	E	-RoHS
Voltage code	Dielectric	Size code	Capacitance code	Tolerance code	Termination code	Lead / Ribbon code	Coating code	Marking code	Tape and reel	
<b>201</b> = 200V <b>301</b> = 300V <b>501</b> = 500V <b>102</b> = 1,000V <b>122</b> = 1,200V <b>152</b> = 1,500V <b>162</b> = 1,600V <b>252</b> = 2,500V <b>362</b> = 3,600V <b>502</b> = 5,000V <b>702</b> = 7,000V  Please refer to voltage given in capacitance range chart	<b>CP</b> = (100 ± 30) ppm/°C	<b>X</b> = 2225 <b>E</b> = 4040	Please refer to Cap.  Code given in capacitance range chart	<b>B</b> = ±0.1pF <b>C</b> = ±0.25pF <b>D</b> = ±0.5pF <b>F</b> = ±1% <b>G</b> = ±2% <b>J</b> = ±5% <b>K</b> = ±10%  See note 1	<b>S</b> = Standard: tin-plated nickel  <b>C</b> = Non-magnetic: tin-plated copper  See note 2	-: no lead or ribbon <b>1</b> = Micro-strip ribbons, RoHS <b>6</b> = Radial leads, non RoHS <b>7</b> = Axial leads, non RoHS  <u>Available on size 4040:</u> <b>1S</b> = Short micro-strip ribbons, RoHS <b>2</b> = Axial ribbons, RoHS <b>3</b> = Radial ribbons, RoHS See note 3	-: no coating <b>H</b> = coating requested	-: no marking <b>L</b> = laser marking	-: no tape and reel <b>E</b> = horizontal orientation CPX: 500 components per reel CPE: 500 or 700 components per reel  <b>X</b> = verticale orientation, only available on CPE, 350 components per reel	The RoHS tag is not part of the reference  Tag added at the end of P/N for information

Note 1: For capacitance values less than 10pF, tolerances B, C and D available. For capacitance values equal to or higher than 10pF, tolerances F, G, J and K available.

Note 2: All terminations are backward compatible and lead-free. The non-magnetic terminations are all Magnetism-free Rated.

Note 3: when coding ribbons or leads for the description of the part, the termination has to be mentioned for MRcertified types to ensure that only non-magnetic materials.

Examples: 362 CPE 470 J1L any termination material could be used. 362 CPE 470 JC1L only non-magnetic termination materials could be used.

Please consult us for specific requirements.

2225: TYPICAL ESR VERSUS CAPACITANCE

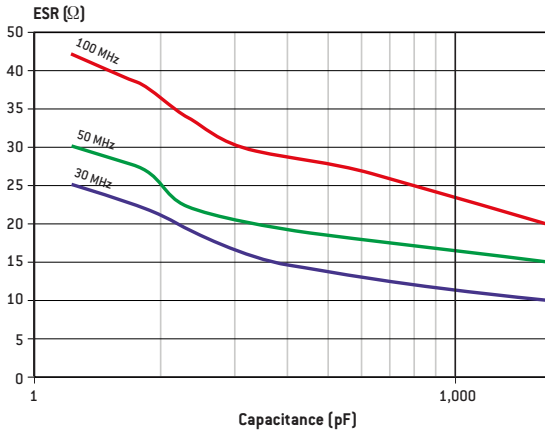

4040: TYPICAL ESR VERSUS CAPACITANCE

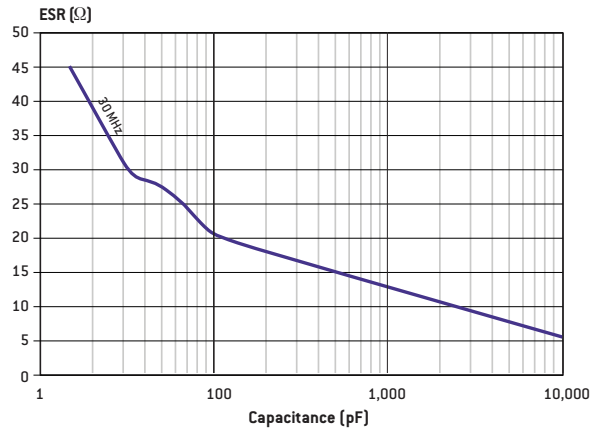

2225: TYPICAL CURRENT RATING VERSUS CAPACITANCE

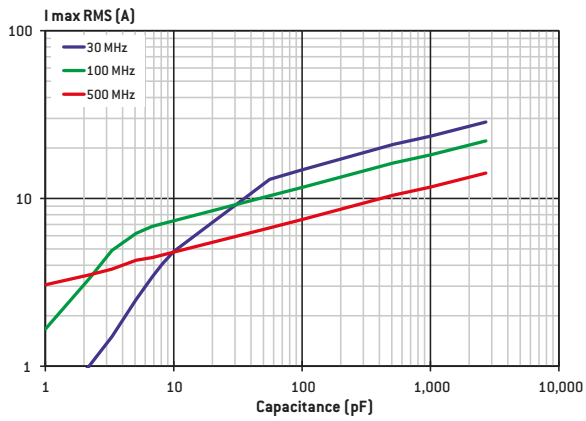

4040: TYPICAL CURRENT RATING VERSUS CAPACITANCE

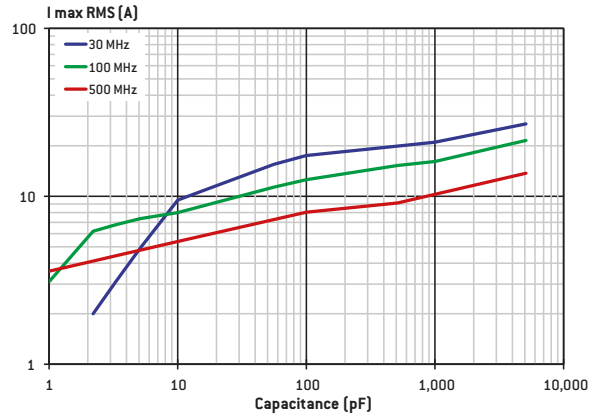

2225: TYPICAL SERIES RESONANT FREQUENCY VERSUS CAPACITANCE

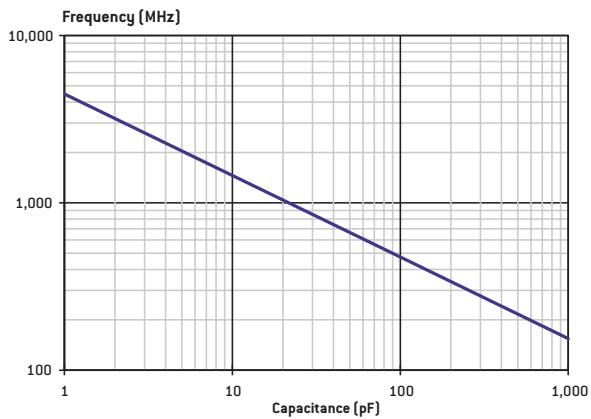

**DIMENSIONS in inches (mm)**

**Chips**

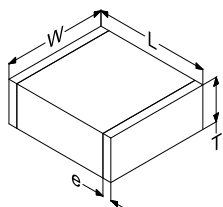

**Micro-strip ribbons: available on all sizes (Type 1)**

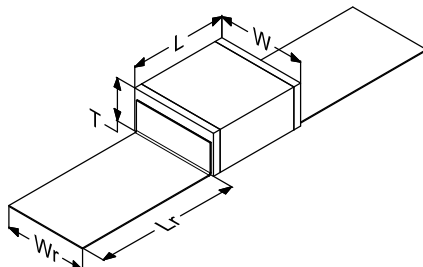

**Short Micro-strip ribbons: available on size E (4040) (Type 1S)**

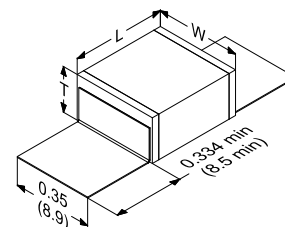

**Axial ribbons: available on size E (4040) (Type 2)**

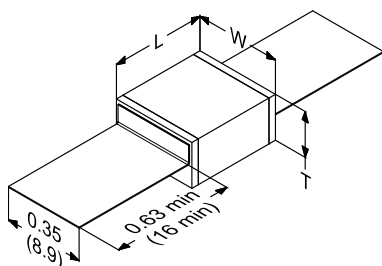

**Radial ribbons: available on size E (4040) (Type 3)**

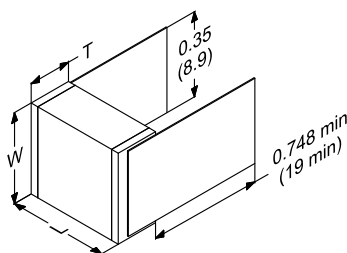

**Radial leads: available on all sizes (Type 6)**

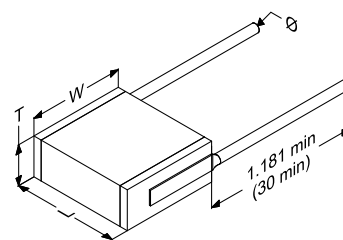

**Axial leads: available on sizes X (2225) and E (4040) (Type 7)**

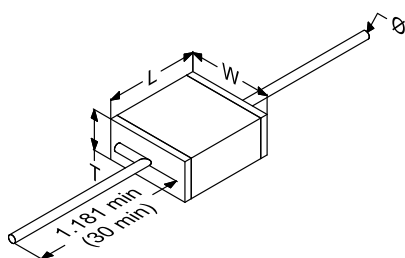

## STANDARD RATINGS

Size		2225		4040	
Size code		X		E	
Dimensions inches (mm)	L	0.244 +0.012 / -0.028 (6.2 +0.3 / -0.7)		0.413 +0.012 / -0.028 (10.5 +0.3 / -0.7)	
	W	0.26 ± 0.02 (6.6 ± 0.5)		0.374 ± 0.02 (9.5 ± 0.5)	
	T	0.15 max (3.8 max)		0.177 max (4.5 max)	
	e	0.032 ± 0.024 (0.8 ± 0.6)		0.032 ± 0.024 (0.8 ± 0.6)	
	Lr	0.472 min (12 min)		0.63 min (16 min)	
	Wr	0.213 (5.4)		0.35 (8.9)	
	Ø	0.024 (0.60)		0.035 (0.90)	
Value (pF)	Cap. Code	Standard	Extended	Standard	Extended
1.0	1R0				
1.1	1R1				
1.2	1R2				
1.3	1R3				
1.4	1R4				
1.5	1R5				
1.6	1R6				
1.7	1R7				
1.8	1R8				
1.9	1R9				
2.0	2R0				
2.1	2R1				
2.2	2R2				
2.4	2R4				
2.7	2R7				
3.0	3R0				
3.3	3R3				
3.6	3R6				
3.9	3R9				
4.3	4R3				
4.7	4R7				
5.1	5R1				
5.6	5R6				
6.2	6R2	2,500V	3,600V	3,600V	7,000V
6.8	6R8				
7.5	7R5				
8.2	8R2				
9.1	9R1				
10	100				
11	110				
12	120				
13	130				
15	150				
16	160				
18	180				
20	200				
22	220				
24	240				
27	270				
30	300				
33	330				
36	360				
39	390				
43	430				
47	470				
51	510				

Special values, tolerances, higher WVDC and matching available, please consult factory.

Size		2225		4040	
Size code		X		E	
Dimensions inches (mm)	L	0.244 +0.012 / -0.028 (6.2 +0.3 / -0.7)		0.413 +0.012 / -0.028 (10.5 +0.3 / -0.7)	
	W	0.26 ± 0.02 (6.6 ± 0.5)		0.374 ± 0.02 (9.5 ± 0.5)	
	T	0.15 max (3.8 max)		0.177 max (4.5 max)	
	e	0.032 ± 0.024 (0.8 ± 0.6)		0.032 ± 0.024 (0.8 ± 0.6)	
	Lr	0.472 min (12 min)		0.63 min (16 min)	
	Wr	0.213 (5.4)		0.35 (8.9)	
	Ø	0.024 (0.60)		0.035 (0.90)	
Value (pF)	Cap. Code	Standard	Extended	Standard	Extended
56	560				
62	620				
68	680				
75	750				
82	820				
91	910				
100	101				
110	111				
120	121	2,500V			
130	131				
150	151			3,600V	
160	161				
180	181				
200	201				
220	221				
240	241				5,000V
270	271				
300	301				
330	331				
360	361	1,500V			
390	391				
430	431				
470	471				
510	511				
560	561			2,500V	
620	621				
680	681				
750	751				
820	821	1,200V			
910	911			1,600V	
1,000	102				
1,100	112				
1,200	122				
1,500	152			1,000V	
1,800	182	500V			
2,200	222				
2,700	272	300V			
3,000	302				
3,300	332				
3,900	392			500V	
4,700	472				
5,100	512				
5,600	562				
6,800	682				
8,200	822			200V	
10,000	103				

Special values, tolerances, higher WVDC and matching available, please consult factory.

# High Power

# CL Series



## FEATURES

- Low ESR/ESL, RF power capacitors
- NP0 capacitors, ultra stability
- RoHS compliant
- Excellent characteristics in current, voltage and power with high Q factor
- Working voltage: 200V - 7,000V
- Sizes: 2225, 4040 and 7065
- Capacitance range: 1pF - 10,000pF
- Laser Marked (optional)

## APPLICATIONS

- RF Power Amplifiers
- Industrial (Plasma Chamber)
- Medical (MRI Coils)

## CIRCUIT APPLICATIONS

- DC Blocking
- Matching Networks
- Tuning and Coupling

## PHYSICAL CHARACTERISTICS

- Chip capacitors for surface mounting with Nickel barrier and tinning or Copper barrier and tinning (non magnetic)
- Ribbon leads for surface mounting, axial or radial leads for through-hole circuits

## ELECTRICAL AND ENVIRONMENTAL SPECIFICATIONS

Electrical specifications	
Parameter	Value
Capacitance	1pF - 10,000pF
Tolerances	B, C, D below 10pF F, G, J, K, M above 10pF
Working voltage (WVDC)	See capacitance range chart
Temperature coefficient	NP0: [0 ± 30] ppm/°C, -55°C to +125°C
Insulation Resistance	10 <sup>5</sup> MΩ min at 25°C at rated WVDC 10 <sup>4</sup> MΩ min at 125°C at rated WVDC
Dielectric Withstanding (test voltage applied for 5 seconds)	2 x WVDC for WVDC ≤ 500V 1.5 x WVDC for 500V < WVDC ≤ 2,500V 1.3 x WVDC for WVDC > 2,500V
Aging	none
Piezo Effect	none

Environmental specifications	
Parameter	Value
Life Test	2,000 hours, +125°C at 1.5 x WVDC (WVDC ≤ 500V) at 1.3 x WVDC (500V < WVDC < 1,250V) at 1 x WVDC (1,250V ≤ WVDC)
Moisture Resistance Test 1	240 hours, 85% relative humidity at 85°C (ESA/SCC n°3009)
Moisture Resistance Test 2	56 days, 93% relative humidity at 40°C 0V, 5V, WVDC or 500V whichever is less

## HOW TO ORDER

362	CL	X	100	G	C	1	-	L	-	-RoHS
Voltage code	Dielectric	Case size	Capacitance code	Tolerance code	Termination code	Lead / Ribbon code	Coating code	Marking code	Tape and reel	
<b>201</b> = 200V <b>301</b> = 300V <b>501</b> = 500V <b>102</b> = 1,000V <b>122</b> = 1,200V <b>152</b> = 1,500V <b>162</b> = 1,600V <b>252</b> = 2,500V <b>362</b> = 3,600V <b>502</b> = 5,000V <b>702</b> = 7,000V  Please refer to voltage given in capacitance range chart	<b>CL</b> = NP0: [0 ± 30] ppm/°C	<b>X</b> = 2225 <b>E</b> = 4040 <b>F</b> = 7065	Please refer to capacitance code given in capacitance range chart	<b>B</b> = ± 0.1pF <b>C</b> = ± 0.25pF <b>D</b> = ± 0.5pF <b>F</b> = ± 1% <b>G</b> = ± 2% <b>J</b> = ± 5% <b>K</b> = ± 10%  See note 1	<b>S</b> = Standard: tin-plated nickel  <u>Available on sizes 2225 and 4040:</u> <b>C</b> = Non-magnetic: tin-plated copper  <u>Available on size 7065:</u> <b>A</b> = Non-magnetic: silver-palladium  See note 2	-: no lead or ribbon <b>1</b> = Micro-strip ribbons, RoHS <b>6</b> = Radial leads, non RoHS  <u>Available on size 4040:</u> <b>1S</b> = Short micro-strip ribbons, RoHS. <b>2</b> = Axial ribbons, RoHS. <b>3</b> = Radial ribbons, RoHS.  <u>Available on sizes 2225 and 4040:</u> <b>7</b> = Axial leads, non RoHS.  See note 3	-: no coating <b>H</b> = coating requested	-: no marking <b>L</b> = laser marking	-: no tape and reel <u>Available on sizes 2225 and 4040:</u> <b>E</b> = horizontal orientation CPX: 500 components per reel CPE: 500 or 700 components per reel  <u>Available on size 4040:</u> <b>X</b> = verticale orientation, only available on CPE, 350 components per reel	The RoHS tag is not part of the reference  Tag added at the end of P/N for information

2225: TYPICAL ESR VERSUS CAPACITANCE

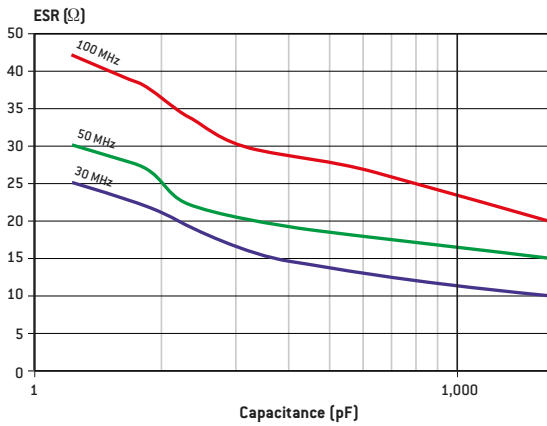

4040: TYPICAL ESR VERSUS CAPACITANCE

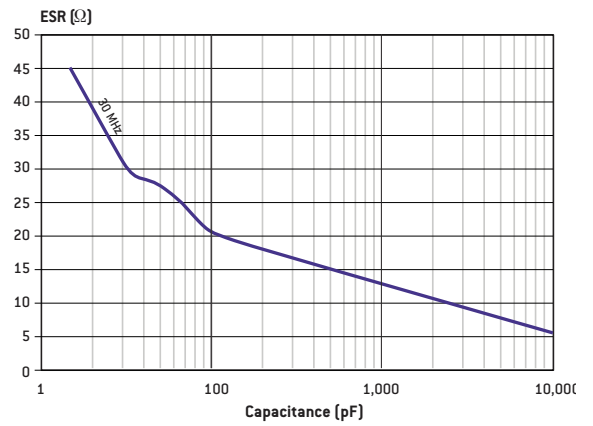

2225: TYPICAL CURRENT RATING VERSUS CAPACITANCE

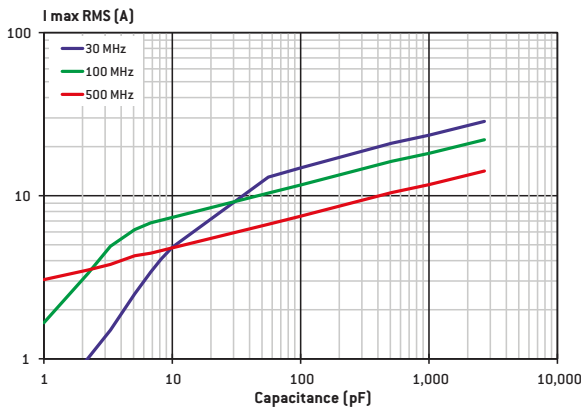

4040: TYPICAL CURRENT RATING VERSUS CAPACITANCE

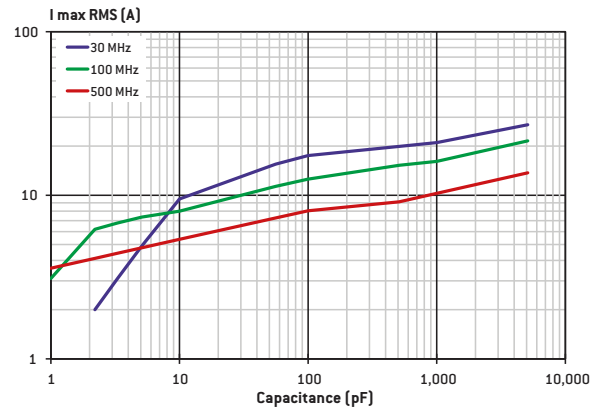

2225: TYPICAL SERIES RESONANCE FREQUENCY VERSUS CAPACITANCE

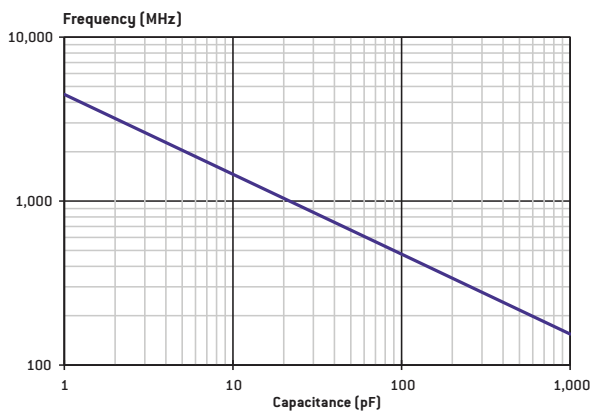

Note 1:

- For capacitance values less than 10pF, tolerances B, C and D available.
- For capacitance values equal to or higher than 10pF, tolerances F, G, J and K available.

Note 2:

- All terminations are backward compatible and lead-free
- The non-magnetic terminations are all Magnetism-free Rated

Note 3: when coding ribbons or leads for the description of the part, the termination has to be mentioned for MR certified types to ensure that only non-magnetic materials are used.

Examples: 362 CLE 470 J1L any termination material could be used  
 362 CLE 470 JC1L only non-magnetic termination materials could be used

Please consult us for specific requirements.



**DIMENSIONS in inches (mm)**

**Chips**

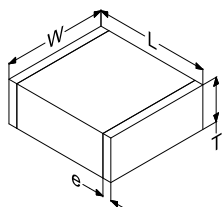

**Micro-strip ribbons: available on all sizes (Type 1)**

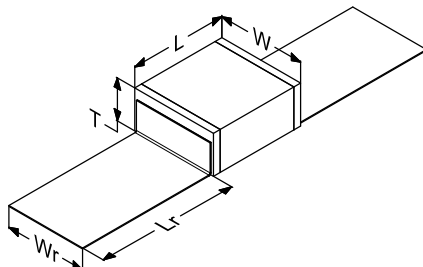

**Short Micro-strip ribbons: available on size E (4040) (Type 1S)**

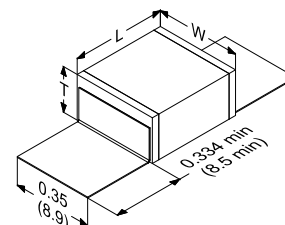

**Axial ribbons: available on size E (4040) (Type 2)**

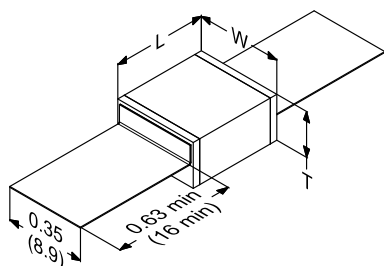

**Radial ribbons: available on size E (4040) (Type 3)**

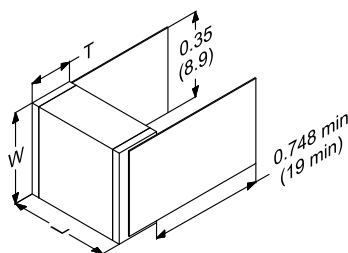

**Radial leads: available on all sizes (Type 6)**

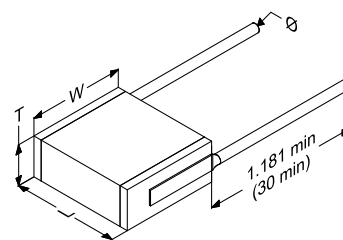

**Axial leads: available on sizes X (2225) and E (4040) (Type 7)**

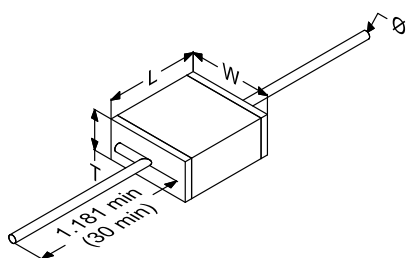

# CL Series

High Power

## STANDARD RATINGS

Size		2225	4040		
Size code		X	E		
Dimensions inches (mm)	L	0.244 +0.012 / -0.028 (6.2+0.3 / -0.7)	0.413 +0.012 / -0.028 (10.5+0.3 / -0.7)		
	W	0.26 ± 0.02 (6.6 ± 0.5)	0.374 ± 0.02 (9.5 ± 0.5)		
	T	0.15 max (3.8 max)	0.177 max (4.5 max)		
	e	0.032 ± 0.024 (0.8 ± 0.6)	0.032 ± 0.024 (0.8 ± 0.6)		
	Lr	0.472 min (12 min)	0.63 min (16 min)		
	Wr	0.213 (5.4)	0.35 (8.9)		
	Ø	0.024 (0.60)	0.035 (0.90)		
Value (pF)	Cap. Code	Standard	Extended	Standard	Extended
1.0	1R0				
1.1	1R1				
1.2	1R2				
1.3	1R3				
1.4	1R4				
1.5	1R5				
1.6	1R6				
1.7	1R7				
1.8	1R8				
1.9	1R9				
2.0	2R0				
2.1	2R1				
2.2	2R2				
2.4	2R4				
2.7	2R7				
3.0	3R0				
3.3	3R3				
3.6	3R6				
3.9	3R9				
4.3	4R3				
4.7	4R7				
5.1	5R1				
5.6	5R6				
6.2	6R2	2,500V	3,600V	3,600V	7,000V
6.8	6R8				
7.5	7R5				
8.2	8R2				
9.1	9R1				
10	100				
11	110				
12	120				
13	130				
15	150				
16	160				
18	180				
20	200				
22	220				
24	240				
27	270				
30	300				
33	330				
36	360				
39	390				
43	430				
47	470				
51	510				

Special values, tolerances, higher WVDC and matching available, please consult factory.

Size		2225	4040	7065		
Size code		X	E	F		
Dimensions inches (mm)	L	0.244 +0.012 / -0.028 (6.2+0.3 / -0.7)	0.413 +0.012 / -0.028 (10.5+0.3 / -0.7)	0.244 +0.012 / -0.028 0.701 ± 0.02		
	W	0.26 ± 0.02 (6.6 ± 0.5)	0.374 ± 0.02 (9.5 ± 0.5)	(178 ± 0.5) 0.63 ± 0.02		
	T	0.15 max (3.8 max)	0.177 max (4.5 max)	(16 ± 0.5) 0.158 max		
	e	0.032 ± 0.024 (0.8 ± 0.6)	0.032 ± 0.024 (0.8 ± 0.6)	(4 max) 0.032 ± 0.024		
	Lr	0.472 min (12 min)	0.63 min (16 min)	(0.8 ± 0.6) 0.236 min		
	Wr	0.213 (5.4)	0.35 (8.9)	(6 min) 0.591		
	Ø	0.024 (0.60)	0.035 (0.90)	(15) 0.035		
Value (pF)	Cap. Code	Standard	Extended	Standard	Extended	Standard
56	560					
62	620					
68	680					
75	750		3,600V			
82	820				7,000V	
91	910					
100	101					
110	111					
120	121	2,500V				
130	131					
150	151			3,600V		
160	161					
180	181					
200	201					
220	221					
240	241				5,000V	
270	271					
300	301					
330	331					
360	361	1,500V				
390	391					
430	431					
470	471					
510	511					
560	561			2,500V		
620	621					
680	681					
750	751					
820	821	1,200V				
910	911			1,600V		
1,000	102					
1,100	112					
1,200	122					
1,500	152			1,000V		
1,800	182	500V				
2,200	222					
2,700	272	300V				
3,000	302					
3,300	332					
3,900	392			500V		
4,700	472					
5,100	512					
5,600	562					
6,800	682					
8,200	822			200V		
10,000	103					1,000V
						500V

Special values, tolerances, higher WVDC and matching available, please consult factory.



## Headquarters

93, rue Oberkampf

75011 PARIS • FRANCE

Tel. : +33 (0)1 49 23 10 00

info@exxelia.com

[www.exxelia.com](http://www.exxelia.com)

### EXXELIA DEARBORN

1221 North US Highway 17-92

Longwood, FL 32750 • USA

Tel. : (407) 695-6562

### EXXELIA MAROC

Angle boulevard Alkahrabae et rue Le Caire

Quartier Industriel Ain Sebaa

CASABLANCA Sidi Bernoussi 20600 • MAROC

Tel. : +00212 22 66 70 00

### EXXELIA MAGNETICS

16, Parc d'Activités du Beau Vallon

57970 ILLANGE • FRANCE

Tel. : +33 (0)3 82 59 13 33

ZI la Levraudière,

85120 ANTIGNY • FRANCE

Tel. : +33 (0)2 51 69 64 25

### EXXELIA RAF TABTRONICS

2854 Genesee St., Route 63

Piffard, New York 14533 • USA

Tel. : +1 585-243-4331 x120

### EXXELIA DEYOUNG

12920 NE 125th Way

Kirkland, WA 98034 • USA

Tel. : +1 425-823-4798

### EXXELIA TANTALUM

Z.I. de Brais - BP 194

44604 SAINT-NAZAIRE CEDEX • FRANCE

Tel. : +33 (0)2 40 01 26 51

### EXXELIA TECHNOLOGIES

#### Headquarters

93, rue Oberkampf

75011 PARIS • FRANCE

Tel. : +33 (0)1 49 23 10 00

#### Plants

Z.A.E. du Chêne Saint-Fiacre

1, rue des Temps Modernes

77600 CHANTELOUP-EN-BRIE • FRANCE

Tel. : +33 (0)1 60 31 70 00

105, rue du Général Leclerc - BP 33

67441 MARMOUTIER Cedex • FRANCE

Tel. : +33 (0)3 88 70 62 00

### EXXELIA SIC SAFCO

Z.I. de Brais - BP 194

44604 SAINT-NAZAIRE CEDEX • FRANCE

Tel. : +33 (0)2 40 01 26 51

### EXXELIA TEMEX

Parc Industriel Bersol 1

Voie Romaine

33600 PESSAC • FRANCE

Tel. : +33 (0)5 56 46 66 66

### EXXELIA VIETNAM

Unit 2A, Standard Factory No. 2,

Road 15, The Tan Thuan EPZ,

Dist.7, Ho Chi Minh City • VIETNAM

Tel. : 00 84 8 3770 1226



**Headquarters**

93, rue Oberkampf

F - 75540 PARIS CEDEX 11 • FRANCE

Tel. : +33 (0)1 49 23 10 00

[info@eurofarad.com](mailto:info@eurofarad.com)

[www.exxelia.com](http://www.exxelia.com)

