



FILM & MICA CAPACITORS

www.dearbornelectronics.com



GENERAL INFORMATION

Guide to Film Capacitors.....	4
Properties of Dielectric Films	5
General Information on Polyester Capacitors	8
General Information on Polyester Film / Foil Types	9
General Information on Polypropylene Capacitors	10
General Information on Polyphenylene Sulfide Capacitors	12
General Information on High Voltage Capacitors	14
General Information of Capacitors for High Frequency Switch Mode Power Supplies	17
Guide to Ordering.....	19
Custom-Designed Film Capacitors	24
High Temperature Type 911P	25
Military Approved Film Capacitors	27
Military Specification Qualifications	28

HERMETICALLY SEALED CAPACITORS 29

METALIZED POLYESTER FILM CAPACITOR

Type 218P.....	30
----------------	----

POLYESTER FILM / FOIL CAPACITOR

Type 409P.....	33
----------------	----

POLYPROPYLENE FILM / FOIL CAPACITOR

Type 700P.....	35
----------------	----

METALIZED POLYPHENYLENE SULFIDE CAPACITORS

Type 820P.....	37
Type 859P.....	40
Type 860P.....	42

METALIZED PAPER / POLYESTER CAPACITOR

Type 118P.....	45
----------------	----

PAPER/FOIL FILM CAPACITOR

Type 103P.....	48
----------------	----

PAPER / POLYESTER FILM CAPACITORS

Type 131P.....	50
Type 132P.....	52
Type CP53 / 54 / 55	54

HIGH VOLTAGE PAPER/POLYESTER FOIL CAPACITORS

Type 205P.....	57
Type CQ72	59

NON-HERMETICALLY SEALED CAPACITORS 63

METALIZED POLYESTER FILM CAPACITORS

Type 430P.....	64
Type 431P.....	66
Type 442P.....	78
Type DPM 90.....	71
Type DPM 907 (HF Switch Mode Power Supplies)	75
Type DPM 907 R1 / R2 (HF Switch Mode Power Supplies)	80
Type DPM 907 N (HF Switch Mode Power Supplies)	85
Type DPM 90 R1 / R2 (HF Switch Mode Power Supplies)	90
Type DPM 94 and DPM 94N (HF Switch Mode Power Supplies)	94
Type DPM 948.....	100

POLYESTER FILM / FOIL CAPACITOR

Type 410P.....	108
----------------	-----

METALIZED POLYPROPYLENE FILM CAPACITORS

Type 709G.....	110
Type 730P / 731P.....	114
Type 730G.....	119
Type 734G.....	122
Type 735P.....	124
Type 744G.....	128
Type 752P.....	130
Type 781P.....	133

POLYPROPYLENE FILM / FOIL CAPACITOR

Type 710P.....	135
----------------	-----

METALIZED POLYPHENYLENE SULFIDE FILM CAPACITORS

Type 832P.....	137
Type 842P.....	140
Type 880P.....	143
Type DKM 94.....	145

POLYPHENYLENE SULFIDE FILM / FOIL CAPACITORS

Type 810P.....	147
Type 882P.....	149

METALIZED-FILM ENERGY STORAGE CAPACITORS 151

Type 282P.....	152
Type 681P.....	154
Type 682P.....	156
Type 684P.....	157

MICA CAPACITORS 159

Type DHT 78 and DHT 78P ⁽¹⁾	160
Type DHT 86 and DHT 86P ⁽¹⁾	165
Type DHT 96.....	171
Type DHT 97 and DHT 97P ⁽¹⁾	175

GUIDE TO FILM CAPACITORS

Dearborn Electronics has more than six decades of experience in developing and manufacturing a wide selection of capacitors for professional and industrial applications.

Our position as a market leader is based on a comprehensive knowledge of the material used and of the performance they can attain. The different technologies developed enable us to meet the users need.

THE CATALOG INCLUDES THE FOLLOWING CAPACITORS:

FOR GENERAL APPLICATIONS:

- Metalized Polyester & Polyester Film / Foil
- Metalized Polypropylene & Polypropylene Film / Foil
- Metalized Polyphenylene Sulfide & Polyphenylene Sulfide Film / Foil

FOR SPECIFIC APPLICATIONS:

- High-Voltage Capacitors
- High-Stability Capacitors
- High-Frequency Switch Mode Power Supplies
- Energy Storage Capacitors
- Military Approved Film Capacitors
- Custom Designed Capacitors

All descriptions, drawings and other data, including dimensions, materials and performance are supplied in this catalogue with the strictest possible accuracy. Nevertheless, the data provided is to be considered general information and can under no circumstance involve Dearborn Electronics liability unless a written agreement has been concluded.

All mechanical and electrical characteristics may vary within reasonable limits depending on the performance of the materials used and on rated manufacturing tolerances.

METALIZED FILM CAPACITORS & FILM FOIL CAPACITORS

Dearborn Electronics film capacitors are obtained by winding two or more layers of dielectric plastic film and metal foil.

The metal is applied by evaporation under vacuum on the dielectric (metalized film capacitors) or consist of separate metal foils (film-foil capacitors). The leads are connected by soldering or brazing.



PROPERTIES OF DIELECTRIC FILMS

POLYESTER (Polyethylene Terephthalate, P.E.T.)

Capacitors with smaller dimensions can be manufactured due to the high dielectric constant and excellent electrical performance of this film. Metalized polyester capacitors also have outstanding self-healing properties.

POLYPROPYLENE (P.P.)

This film features very low dielectric losses, low dielectric adsorption, high dielectric strength, very high insulating strength and a practically linear temperature coefficient in all temperature ranges.

All these properties make this film suitable for the manufacturing of power electronics capacitors.

However, the operating temperature is limited to 105°C.

POLYPHENYLENE SULFIDE (P.P.S.)

The properties of this film are as follows: very low dielectric losses, low temperature coefficient, high stability of the capacitance value, resistant to humidity and a high melting point. This material is suited for surface mounted precision capacitors (SMD). This film also has high temperature advantages and can be used for temperature up to 150°C.

PROPERTIES OF METALIZED FILM CAPACITORS

The metalized film consists of an extremely thin layer (some hundredths μm) of zinc or aluminum deposited by evaporation under vacuum on the dielectric. The nature, thickness and geometry of the metalized layer modify the properties of the capacitors, especially as far as permissible peak or effective current is concerned.

Metalized film capacitors are smaller than film-foil capacitors.

Self-healing is a fundamental property of these capacitors. When a dielectric breakdown occurs between the metal layers, due to a dielectric failure, an electrical arc causes local vapor deposition of the metallization which results in an insulating metallic oxide. Thus regenerated, the capacitor is once again operational.

The self-healing operation generally requires only a very small amount of energy (5 to 15 μJoules) and is performed in several $\mu\text{seconds}$ (< 50). However, a minimum amount of energy is required below which self-healing operations are unpredictable. This energy is calculated in relation to the capacitance value and the load voltage: $E = 1 / 2 CV^2$.

PROPERTIES OF FILM-FOIL CAPACITORS

Film Foil capacitors are especially recommended to meet high voltage or current and / or power stresses.

The thickness of the metal foil enables the reduction of the series resistance and improves the general performance of the capacitors. These improvements are made to the detriment of the volume of the capacitor which also loses its self-healing properties. Composite dielectrics combine films of different types with complementary specific characteristics.

For high voltage and power electronics applications, these capacitors are usually impregnated with impregnating fluids or solid substances.

CAPACITOR PERFORMANCE VS. TEMPERATURE

The capacitors' performance versus temperature essentially depends upon the dielectric type.

The figure below shows ranges of operating temperatures.

% OF CAPACITANCE CHANGE VS. TEMPERATURE (°C)

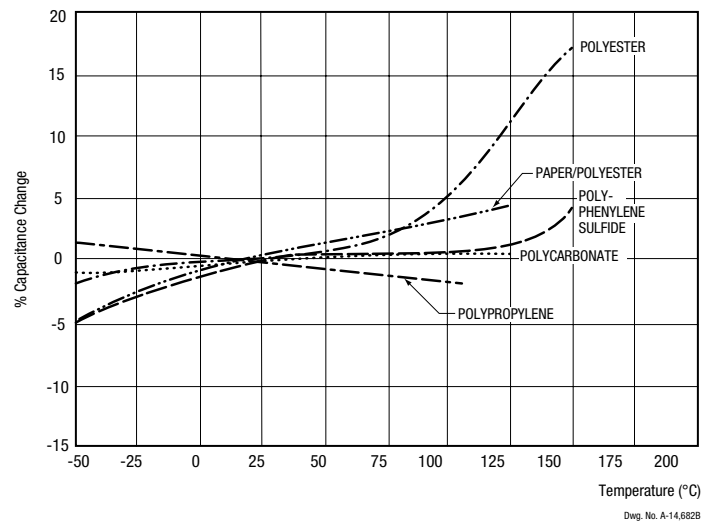

Important differences affect the laws governing the changes of the main electrical characteristics.

They are highlighted by the following curves:

% OF DISSIPATION FACTOR (DF) VS. TEMPERATURE (°C)

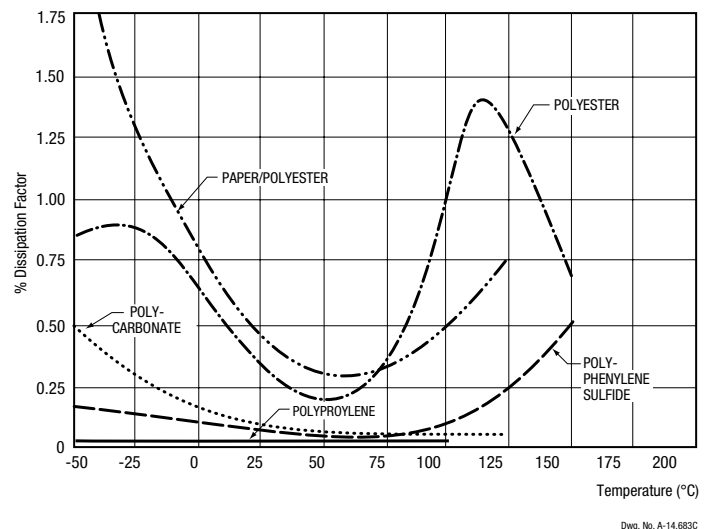

PROPERTIES OF DIELECTRIC FILMS

% OF DISSIPATION FACTOR (DF) VS. FREQUENCY (HZ)

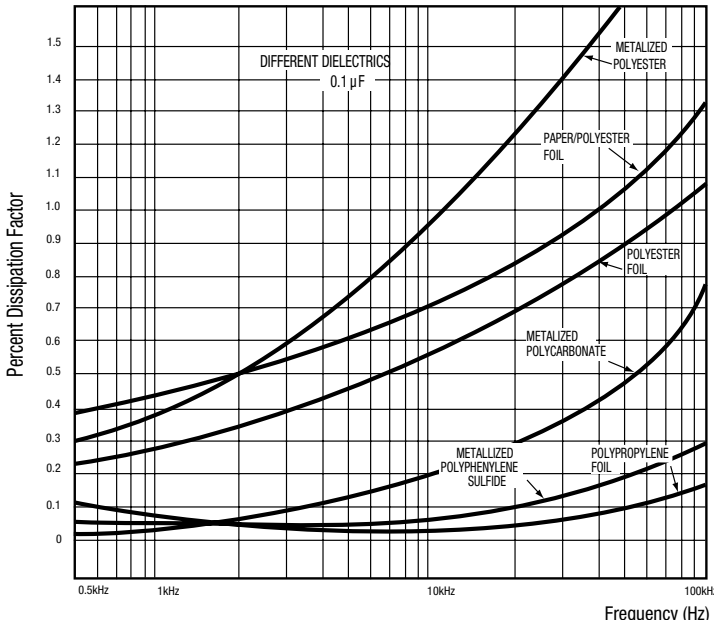

A REAL CAPACITOR MAY BE REPRESENTED BY THE FOLLOWING DIAGRAM:

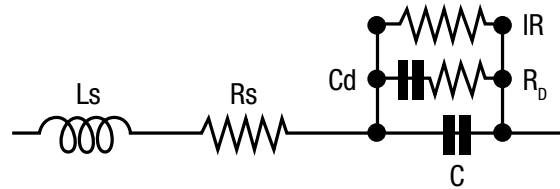

Series Inductance	Ls
Resistance of metal foil & connections	Rs
Insulation Resistance	IR
Dielectric Absorption	Cd
Resistance equivalent to the dielectric losses	R _D
Capacitance	C

Resistive terms generate temperature rises when the capacitors carry AC current (I_{rms}). Depending upon the frequency range, they may be more or less preponderant.

THE EQUIVALENT SERIES RESISTANCE (ESR) IS THE SUM OF THE FOLLOWING TERMS:

$$ESR = R_s + DF / C\omega + 1 / IR C^2 \omega^2$$

When the frequency increases, the term $1 / IRC^2\omega^2$ becomes rapidly insignificant.

For plastic dielectrics, losses remain constant within a wide range of frequencies and the affect of the term: $DF / C\omega$ decreases: $ESR = R_s + DF / C\omega$

The metal foil and the connections are designed to obtain a resistance value (R_s) as low as possible. This value is dependent on the capacitors' technology and geometry.

Inductance (L_s) also disturbs the equation of the capacitors at high frequencies.

IMPEDANCE (Z) IS STATED AS FOLLOWS:

$$Z = R_s^2 + (L_s\omega - 1 / C\omega)^2$$

When frequency increases, the affect of L_s will gradually cancel the capacitance component of the capacitors until it reaches the resonance frequency where:

$$Z = R_s \text{ and } LC\omega^2 = 1$$

IR VS. TEMPERATURE (°C)

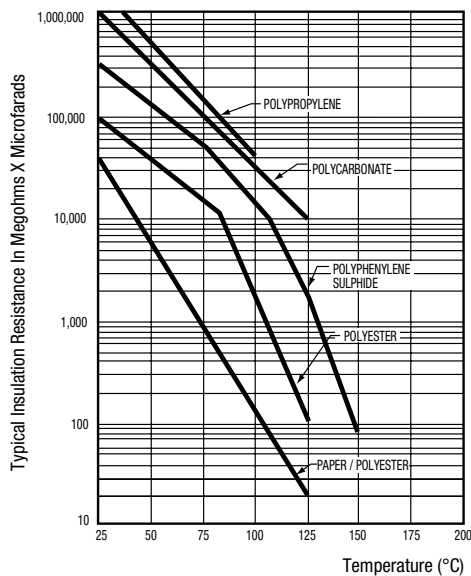

GENERAL INFORMATION ON POLYESTER CAPACITORS

GENERAL INFORMATION

One of the principle characteristics of these capacitors is their small size. This is due to the high dielectric constant and high dielectric strength of the film. They also have superior self-healing properties. They may be used in AC sine wave or non sine wave applications.

GENERAL ELECTRICAL, PHYSICAL, AND ENVIRONMENTAL CHARACTERISTICS

ELECTRICAL CHARACTERISTICS:

Capacitance, dissipation factor, insulation resistance, and dielectric strength shall be measured as specified.

PHYSICAL CHARACTERISTICS:

The lead strength shall be measured as specified.

ENVIRONMENTAL CHARACTERISTICS:

Vibration Test:

Units shall be tested as required. As a result of the test no mechanical damage, short, open or intermittent circuit.

MOISTURE RESISTANCE:

The hermetically sealed units shall be tested.

As a result of the test there shall be:

- No visible damage
- Max. ΔC of $\pm 10\%$
- Min. IR = 50% of initial limit
- Max. DF = 2.0%

HUMIDITY TEST:

The non-hermetically sealed units shall be tested.

As a result of the test there shall be:

- No visible damage
- Max. ΔC of $\pm 10\%$
- Min. IR = 20% of initial limit
- Max. DF = 2.0%

DC LIFE:

125% of rated voltage at 85°C (125°C for Type 218P) for 250 hours except for Type 430P units rated at 1,000 VDC or greater which shall be tested at 100% of rated voltage at 40°C for 1,000 hours.

As a result of the test there shall be:

- No permanent open or short circuit
- No visible damage
- Max. ΔC of $\pm 10\%$
- Min. IR = 50% of initial limit
- Max. DF = 2.0%

GENERAL INFORMATION ON POLYESTER CAPACITORS

CHARACTERISTICS

CAPACITANCE CHANGE VS. TEMPERATURE - METALIZED POLYESTER

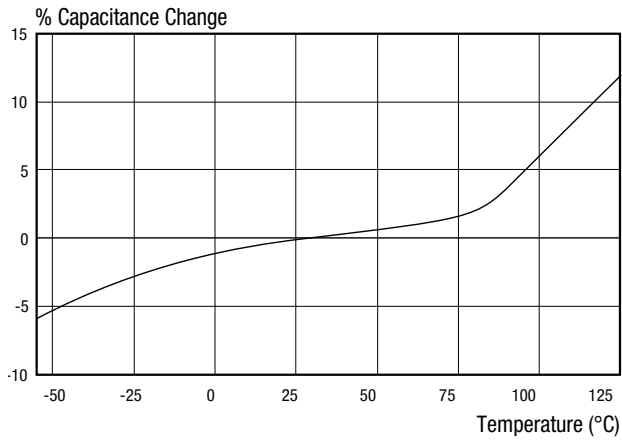

CAPACITANCE CHANGE VS. FREQUENCY - METALIZED POLYESTER

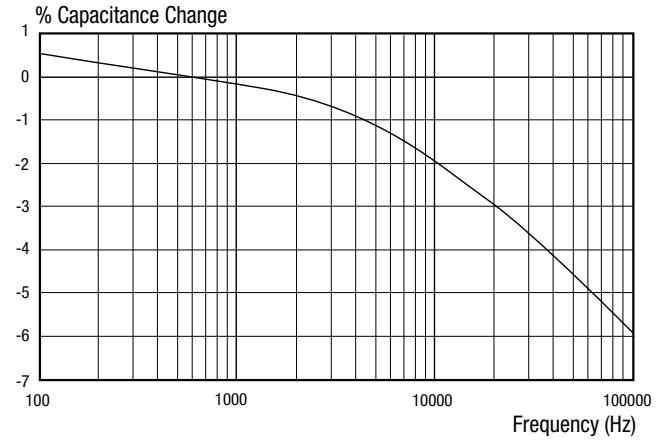

DISSIPATION FACTOR VS. TEMPERATURE - METALIZED POLYESTER

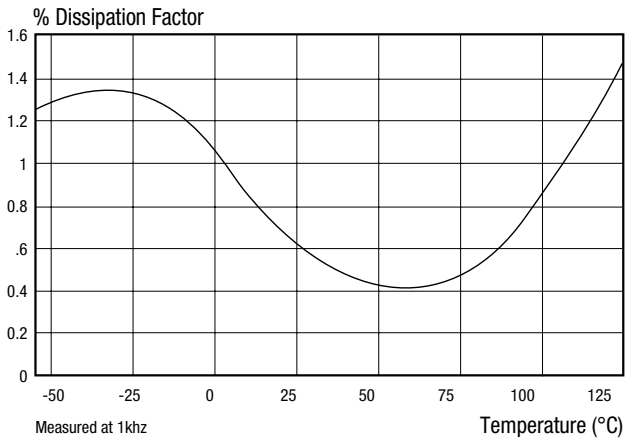

DISSIPATION FACTOR VS. FREQUENCY - METALIZED POLYESTER

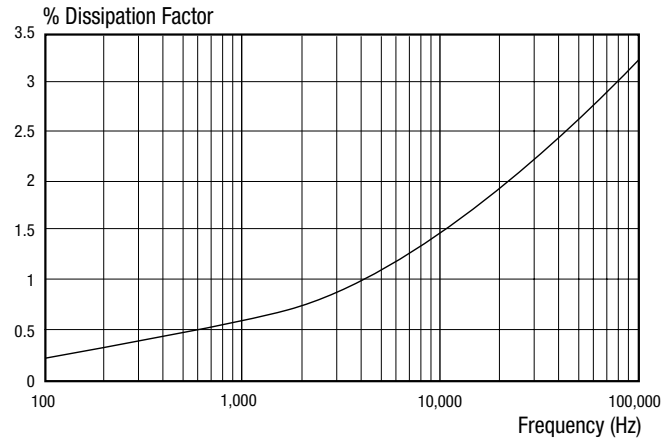

INSULATION RESISTANCE VS. TEMPERATURE - METALIZED POLYESTER

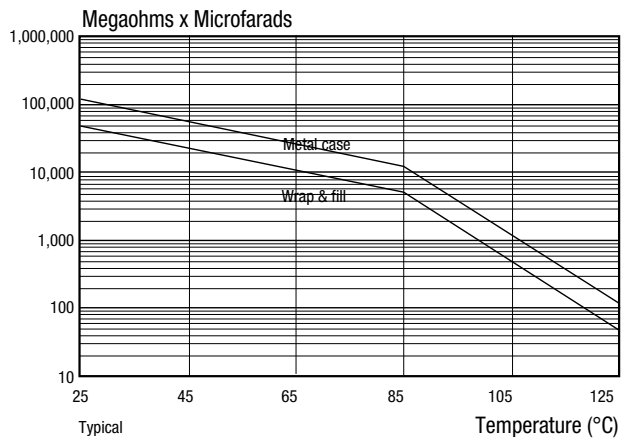

TYPICAL CHARACTERISTICS POLYESTER FILM / FOIL TYPES

TYPICAL CHARACTERISTICS

CAPACITANCE CHANGE VS. TEMPERATURE

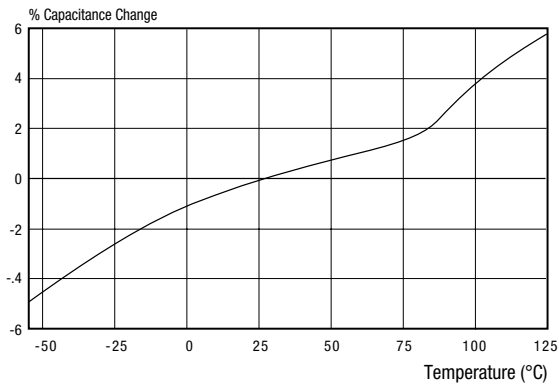

INSULATION RESISTANCE VS. TEMPERATURE

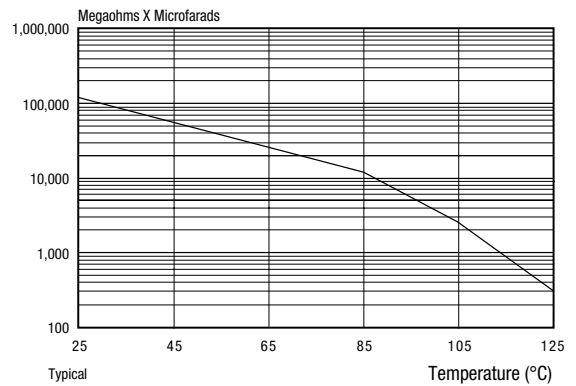

DISSIPATION FACTOR VS. TEMPERATURE

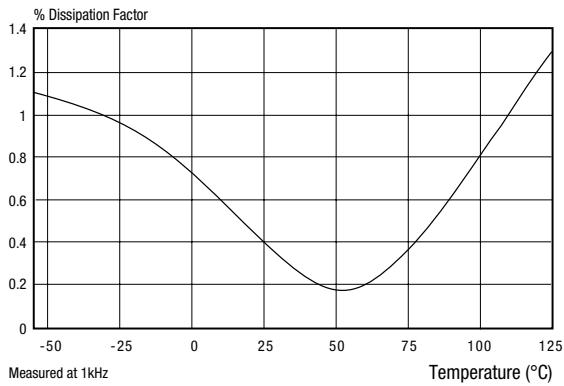

Measured at 1kHz

GENERAL INFORMATION ON POLYPROPYLENE CAPACITORS

GENERAL INFORMATION

Polypropylene has excellent mechanical, chemical and electrical properties due to its non-polar structure. This film is characterized by very low dielectric losses, small dielectric absorption, high dielectric strength, very high insulating resistance and a practically linear temperature coefficient in all temperature ranges. All these properties make this film highly attractive for manufacturing precision capacitors or for power electronics capacitors.

GENERAL ELECTRICAL, PHYSICAL, AND ENVIRONMENTAL CHARACTERISTICS

ELECTRICAL CHARACTERISTICS:

Capacitance, dissipation factor, insulation resistance, and dielectric strength shall be measured as specified.

PHYSICAL CHARACTERISTICS:

The Lead Strength shall be measured as specified.

ENVIRONMENTAL CHARACTERISTICS:

Vibration Test:

Units shall be tested as required. As a result of the test no mechanical damage, short, open or intermittent circuit.

MOISTURE RESISTANCE:

The hermetically sealed units shall be tested.

As a result of the test there shall be:

- No visible damage
- Max. ΔC of $\pm 0.25\%$
- Min. IR = 33% of initial limit
- Max. DF = 0.12%

HUMIDITY TEST:

The Non-Hermetically sealed units shall be tested.

As a result of the test there shall be:

- No visible damage
- Max. ΔC of $\pm 2\%$; $\pm 5\%$ for 731P, 744G, 752P, and 781P
- Min. IR = 20% of initial limit
- Max. DF = 0.12%

DC LIFE:

125% of rated voltage at 85°C for 250 hours (110% for 781P, 70°C for 730G).

As a result of the test there shall be:

- No open or short circuit
- No visible damage
- Max. ΔC of $\pm 2\%$; 3% for 781P
- Min. IR = 33% of initial limit
- Max. DF = 0.12%; 2.5% for 781P

CAPACITANCE CHANGE VS. TEMPERATURE - METALIZED POLYPROPYLENE

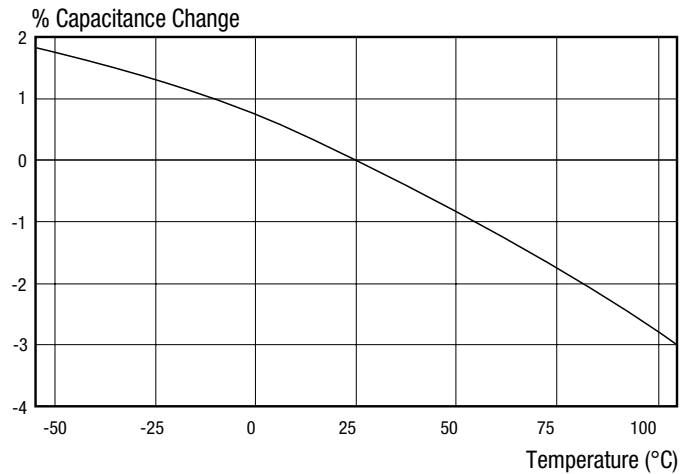

DISSIPATION FACTOR VS. TEMPERATURE - METALIZED POLYPROPYLENE

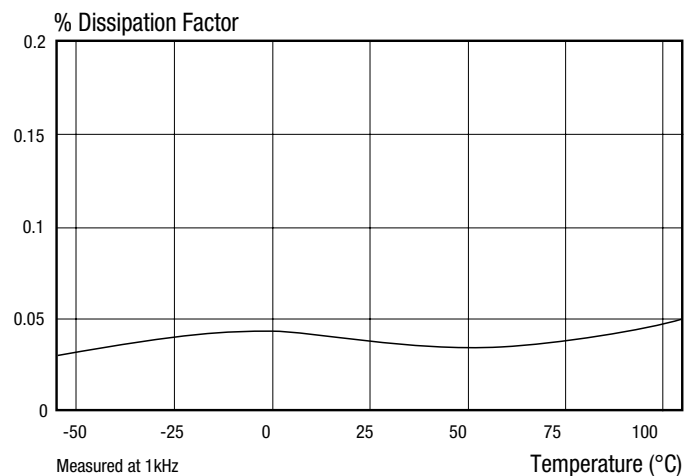

GENERAL INFORMATION ON POLYPROPYLENE CAPACITORS

CAPACITANCE CHANGE VS. FREQUENCY - METALIZED POLYPROPYLENE

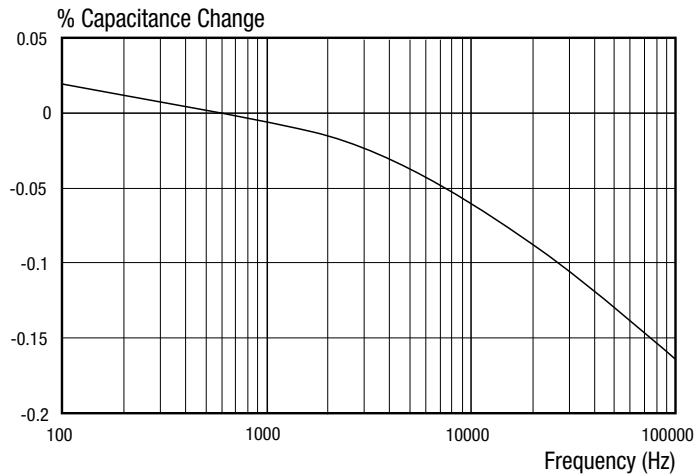

INSULATION RESISTANCE VS. TEMPERATURE - METALIZED POLYPROPYLENE

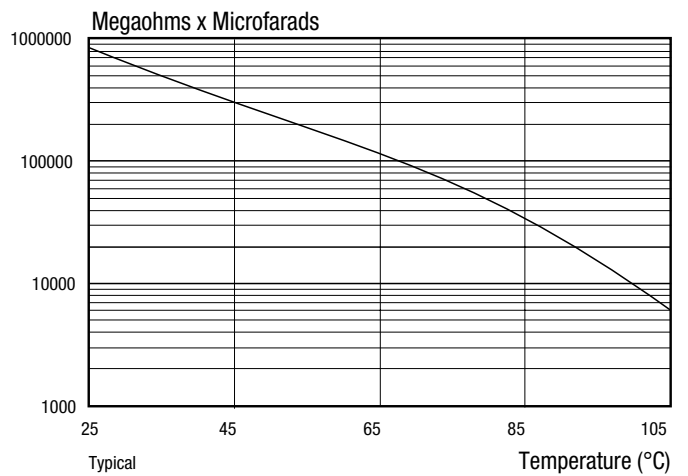

DISSIPATION FACTOR VS. FREQUENCY - METALIZED POLYPROPYLENE

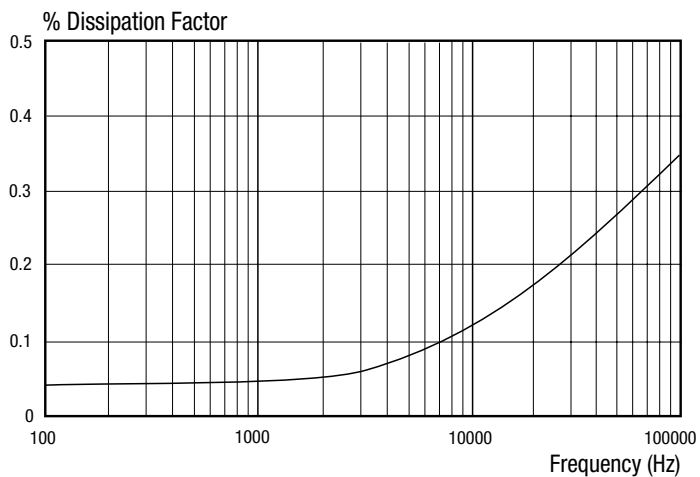

GENERAL INFORMATION ON POLYPHENYLENE SULFIDE CAPACITORS

GENERAL ELECTRICAL, PHYSICAL, AND ENVIRONMENTAL CHARACTERISTICS

ELECTRICAL CHARACTERISTICS:

Capacitance, dissipation factor, insulation resistance, and dielectric strength shall be measured as specified.

PHYSICAL CHARACTERISTICS:

The lead strength shall be measured as specified.

ENVIRONMENTAL CHARACTERISTICS:

Vibration Test:

Units shall be tested as required. As a result of the test no mechanical damage, short, open or intermittent circuit.

MOISTURE RESISTANCE:

The hermetically sealed units shall be tested.

As a result of the test there shall be:

- No visible damage
- Min. IR = 50% of initial limit
- Max. ΔC of $\pm 5\%$
- Max. DF = 0.5%

HUMIDITY TEST:

The non-hermetically sealed units shall be tested.

As a result of the test there shall be:

- No visible damage
- Min. IR = 50% of initial limit
- Max. ΔC of $\pm 5\%$
- Max. DF = 0.5%

DC LIFE:

820P, 842P, 859P are tested in accordance with the applicable Mil Spec.
810P, 832P, 860P & 882P: 140% of rated voltage at 125°C for 250 hours
880P: 125% of rated voltage for 250 hours at 150°C.

As a result of the test there shall be:

- No permanent open or short circuit
- Max. ΔC of $\pm 5\%$
- Max. DF = 0.3%
- No visible damage
- Min. IR = 50% of initial limit







AC LIFE:

The Type 859P shall be tested at 110% of the rated rms voltage at 400Hz for 250 hours at 85°C.

As a result of the test there shall be:

- No permanent open or short circuit
- Max. ΔC of $\pm 5\%$
- Max. DF = 0.5%
- No visible damage
- Min. IR = 50% of initial limit

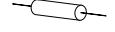
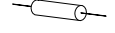
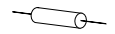
METALIZED POLYCARBONATE / POLYPHENYLENE SULFIDE

POLYPHENYLENE SULFIDE (Replacement for Polycarbonate)			POLYCARBONATE		POLYCARBONATE / POLYPHENYLENE SULFIDE			
Part Number	Mil Spec Number	Catalog Page	Part Number	Mil Spec Number	Outline Drawing	Description	Cap Range μF	DC Voltage Range
859P	39022 / 12	40	259P	39022 / 7		AC Rated -55°C to +105°C	0.01 - 10.0	80 - 440 VAC
860P	-	42	260P	-		Various Configurations 55°C to +105°C	0.01 - 10.0	200 - 600
820P	39022 / 13	37	620P	39022 / 10		Small Size -55°C to +125°C	0.01 - 15.0	50 - 400
-	95008	-	629P	83439 / 4 / 6 95008		Feed Thru -55°C to +125°C	0.01 - 15.0	50 - 400
832P	-	137	632P	-		Wrap & Fill -55°C to +125°C	0.001 - 10.0	63 - 400
842P	55514 / 13	140	642P	55514 / 7		Miniature Wrap & Fill -55°C to +125°C	0.01 - 15.0	50 - 200
880P	-	143	-	-		High Temp, PPS -55°C to +150°C	0.0047 - 10.0	50 - 400
FILM / FOIL POLYCARBONATE / POLYPHENYLENE SULFIDE								
810P	-	147	610P	-		Pulse Capacitor -55°C to +125°C	0.001 - 1.0	50 - 400
882P	-	149	-	-		Zero TCC PPS -55°C to +125°C	0.001 - 0.22	200

GENERAL INFORMATION ON POLYPHENYLENE SULFIDE CAPACITORS

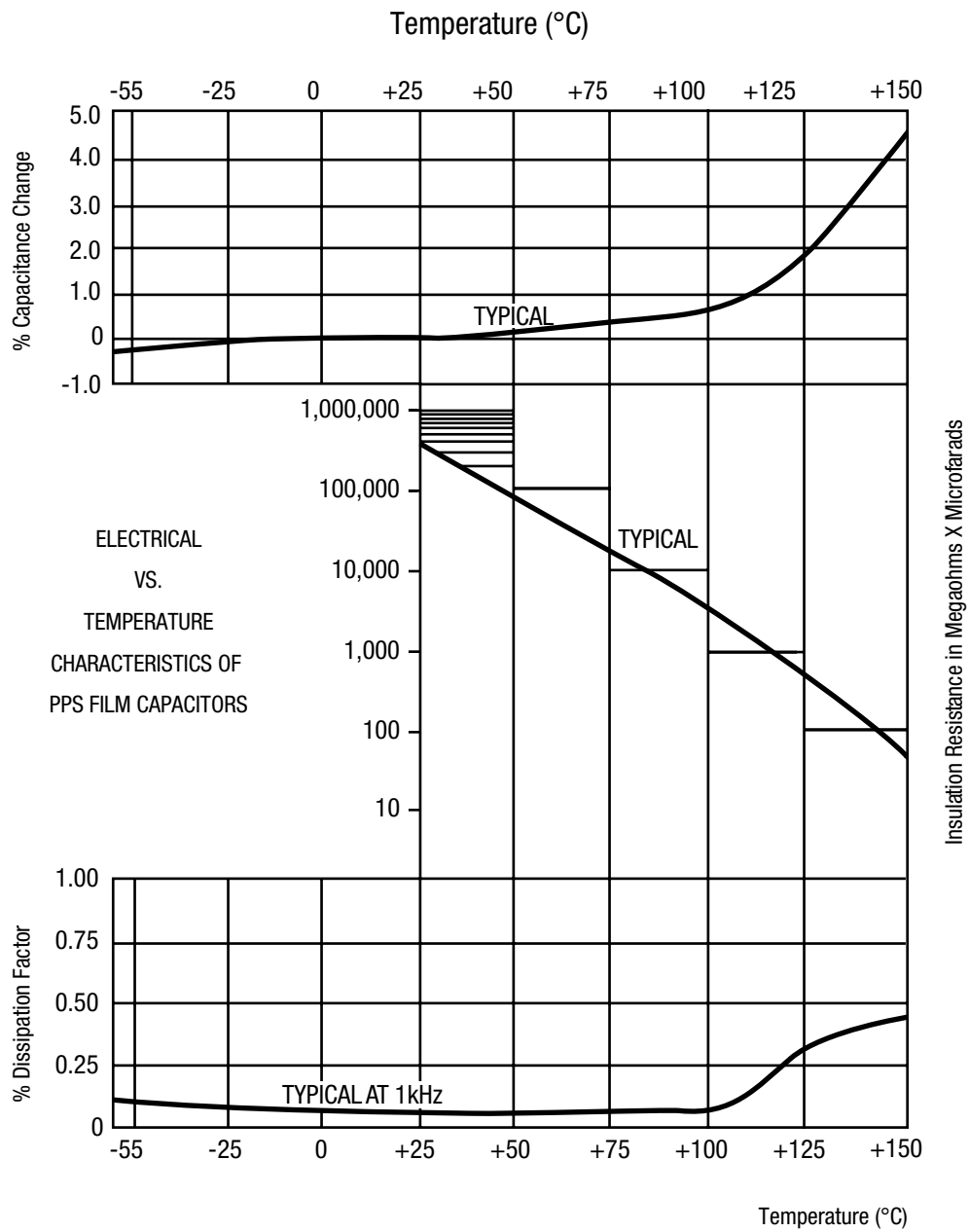

Dwg. No. A-14,582

GENERAL INFORMATION ON HIGH VOLTAGE CAPACITORS

GENERAL INFORMATION

CONSTRUCTION

Various composite dielectrics (plastic + paper or reconstituted mica) are used for manufacturing high-voltage capacitors.

They are impregnated with solid thermo-setting resins such as epoxy, polyester or silicones.

This technology gives very high stability of mechanical and electrical characteristics with a temperature range of - 55°C to + 125°C or + 155°C and even + 200°C on request.

Rated voltage is applicable for all temperature ranges indicated on the data sheet (DHT 78 - DHT 86 - DHT 97).

ELECTRICAL CHARACTERISTICS VS. TEMPERATURE

(Plastic composite)

INSULATION RESISTANCE CHANGE VS. TEMPERATURE

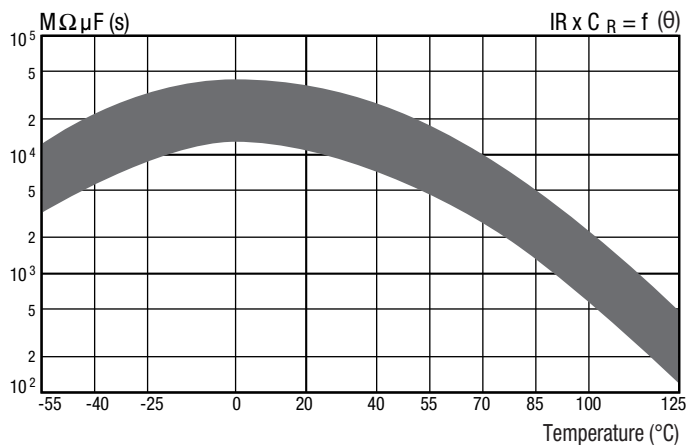

CAPACITANCE CHANGE VS. TEMPERATURE

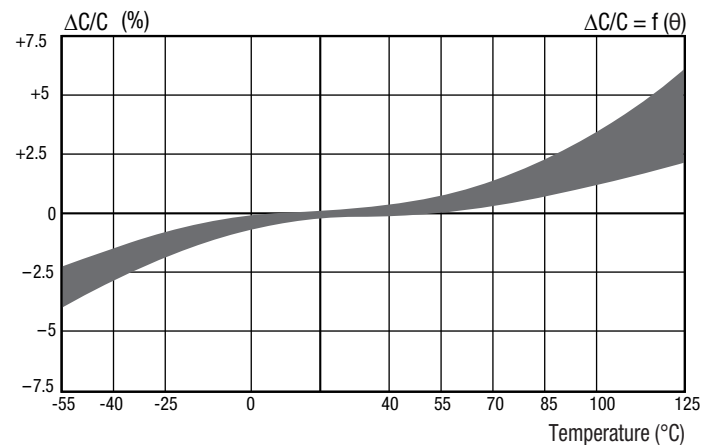

DISSIPATION FACTOR VS. TEMPERATURE

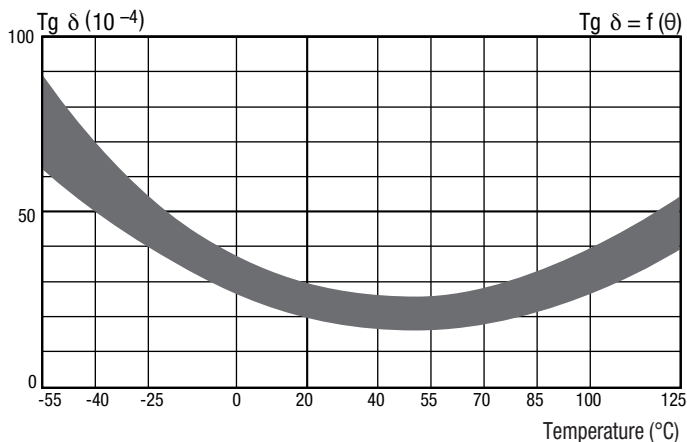

LEAKAGE CURRENT VARIATION VS. TEMPERATURE

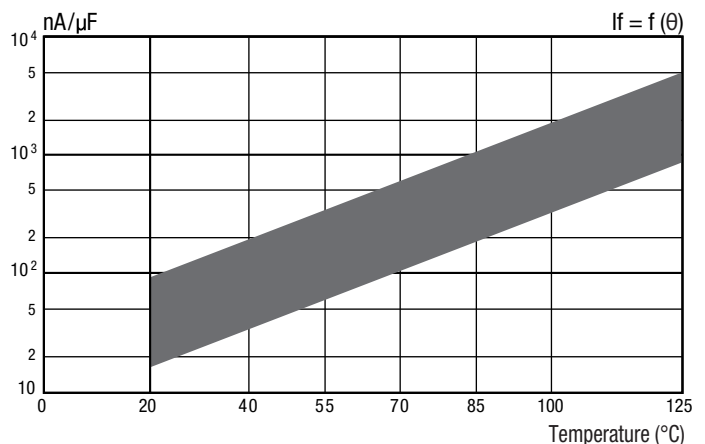

GENERAL INFORMATION ON HIGH VOLTAGE CAPACITORS

ELECTRICAL CHARACTERISTICS VS. TEMPERATURE

(Composite reconstituted mica)

INSULATION RESISTANCE CHANGE VS. TEMPERATURE

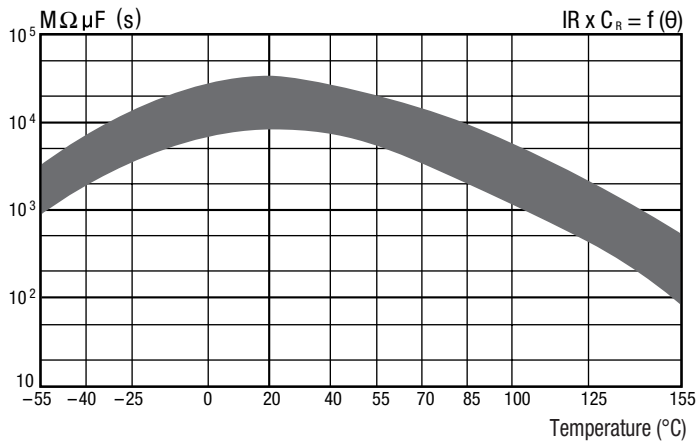

LEAKAGE CURRENT VARIATION VS. TEMPERATURE

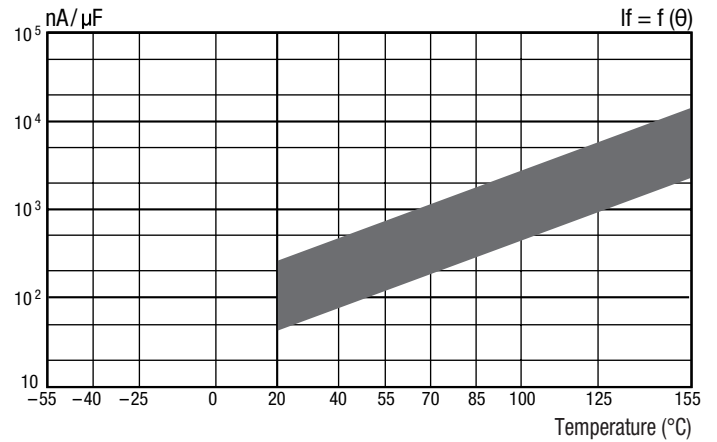

CAPACITANCE CHANGE VS. TEMPERATURE

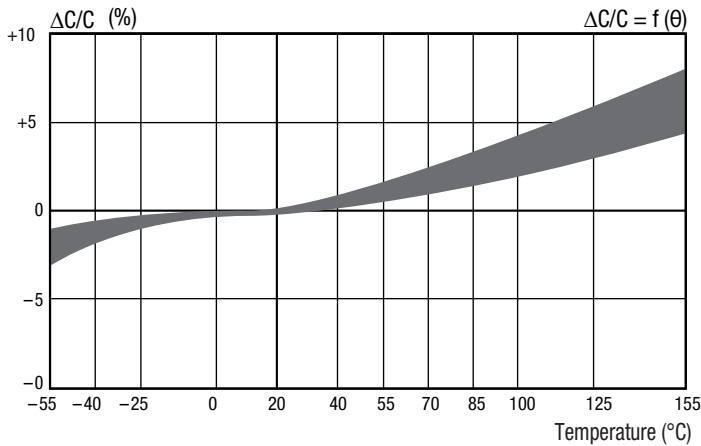

DISSIPATION FACTOR VS. TEMPERATURE

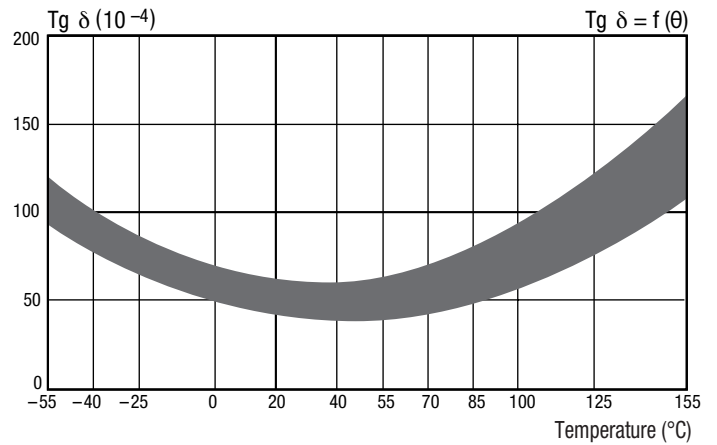

PEAK AC VOLTAGE VS. FREQUENCY (Percent of rated DC voltage)

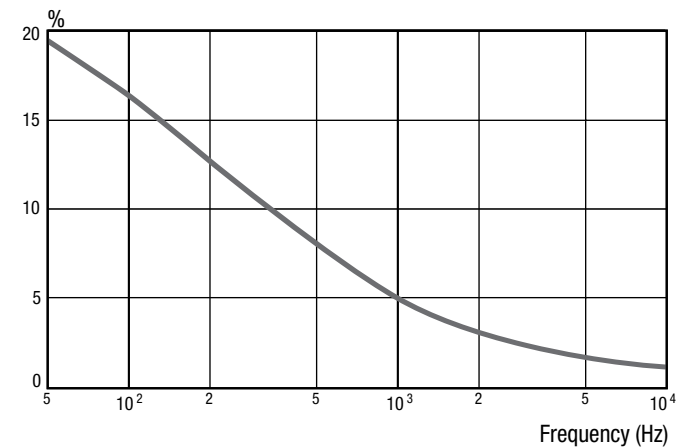

GENERAL INFORMATION ON HIGH VOLTAGE CAPACITORS

FILTERING

The sum of DC voltage and superimposed AC peak voltage shall not exceed the value of the rated DC voltage V_{RC} . In addition, the value of the superimposed AC peak voltage is determined in the diagram on the previous page.

RAPID DISCHARGES PULSE RATINGS

Due to the technology used, high-voltage capacitors are highly recommended for energy storage, retardation lines, and low impedance circuits. For these applications, service life depends on various parameters, such as: discharge shape and mode, repetition frequency, operating mode, environmental conditions.

Please contact our technical department for further information on these applications.

SPECIAL CHARACTERISTICS

Due to the vast experience in this domain we can also propose capacitors with special characteristics such as:

- Capacitors free from partial discharges
- Special test voltage capacitors
- High-reliability capacitors
- Capacitors manufactured according to customer specifications.

RECOMMENDATIONS BEFORE USE

Dearborn's mica composite (DHT 78, DHT 86, DHT 96, DHT 97 etc.) capacitors, can be stored for a maximum period of 2 years in their original packaging* (Stored in normal environmental conditions).

The following procedure should be followed in function of the storage time (the storage time is the time between delivery and the date of unpacking from the original packaging):

- From 0 to 12 months:
 - no instructions.
- From 12 to 18 months:
 - dried in a ventilated chamber,
 - conditions = 24 hours at 100°C for composite technology 24 hours at 125°C for mica reconstituted composite technology.
- From 18 months to 2 years:
 - dried in a ventilated chamber,
 - conditions = 48 hours at 100°C for composite technology 48 hours at 125°C for mica reconstituted composite technology.

When removed from storage the capacitors should be used within 3 months. During this period extreme care should be taken in handling all high voltage components.

If the capacitors are not used within the 3 months period the following procedure should be followed:

- Cleaned
- Dried in a ventilated chamber, conditions = 24 hours at 100°C for composite technology 24 hours at 125°C for mica reconstituted composite technology.

* Long life packaging can be provided on request (contact our Sales Department).

NOTE

By extreme care it is understood that standard precautions are applied when handling high voltage components.

For example:

- Handling by qualified personnel only
- Electrical security regulations must be respected
- Component electrical characteristics must be respected
- Storage and handling in a clean and dry area free from aggressive chemical substances
- Handle with care to avoid unnecessary shock, scrapes, dents
- Handle with gloves and / or clean before power on (check compatibility of cleaning solvent)
- Dry and clean before integrating into a potted, varnished or impregnated equipment or subassembly

IDENTIFICATION AND CONNECTION OF EXTERNAL FOIL

The external foil, which covers about three-quarters of the body of the capacitor, is identified by a black line to the left of the marking. Voltage applied to the lead connected to this external foil is equal and constant in all this area.

The internal foil and corresponding voltage potential concerns the remaining quarter.

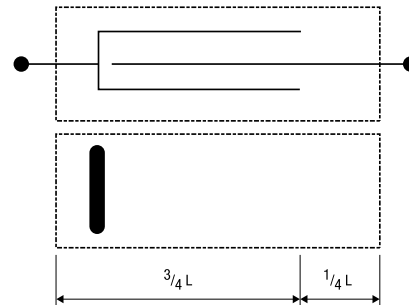

Generally, the external foil is connected to the voltage potential which is the closest to the environment, that is, the lowest potential (in absolute value). The internal foil is connected to the higher voltage potential – HT or + HT.

An insulation of 500 V is specified for “polyester wrapped” versions (DHT 78, DHT 86, DHT 97) and “premolded” versions (DHT 78 P, DHT 86 P, DHT 97P) while an insulation of 5,000 V is specified for “epoxy resin molded” versions (DHT 96).

If a higher insulation is needed, it should be requested by the user.

For capacitors manufactured “on custom request” a preferred type of connection may be specified to preserve the insulation between leads and casing as well as the electrical field orientation.

Although these capacitors are not polarized, testing during production and burn-in tests “orients” the dielectric.

It is recommended to observe the polarity which is clearly marked.

GENERAL INFORMATION ON CAPACITORS FOR HIGH FREQUENCY SWITCH MODE POWER SUPPLIES

Capacitor types DPM 90 and DPM 94 are specially manufactured for use in switch mode power supplies.

FILM SELECTION

Dearborn manufactures film capacitors using most of the technologies available, especially polyester, polypropylene and polyphenylene sulfide films which have good intrinsic properties suited to certain applications where current, temperature, power and high voltage are very important parameters.

For manufacturing filtering capacitors for high frequency switch mode power supplies, Dearborn uses mainly P.E.T.

- P.E.T. (Polyethylene terephthalate / polyester)

CONSTRUCTION

The construction of the electrodes aims at reducing the series inductance value which is the main cause of resonance. This feature together with low series resistance values gives very low impedance values at high frequencies.

These models are recommended for use in a frequency range from 20 / 30kHz to 1MHz Their performances are comparable, or sometimes better than the X7R ceramic capacitors, and they are available in almost identical sizes.

At such frequencies, capacitors with liquid or solid electrolyte become inefficient.

Main characteristics of these capacitors:

- Small size
- Self healing properties
- High temperature range
- High RMS current
- High voltage gradient
- Low ESR and low inductance
- Light weight
- No variation of capacitance versus applied voltage.

The evolution of the different characteristics in function of frequency or temperature are determining factors when it comes to choosing adequate capacitors for Military and Industrial applications.

MOUNTING METHOD

Surface-mounted components can be mounted by vapor phase or in a convection oven. Temperature limits can be viewed in the graph below:

VAPOR PHASE SOLDERING, IN-LINE-SYSTEM WITH PREHEATING

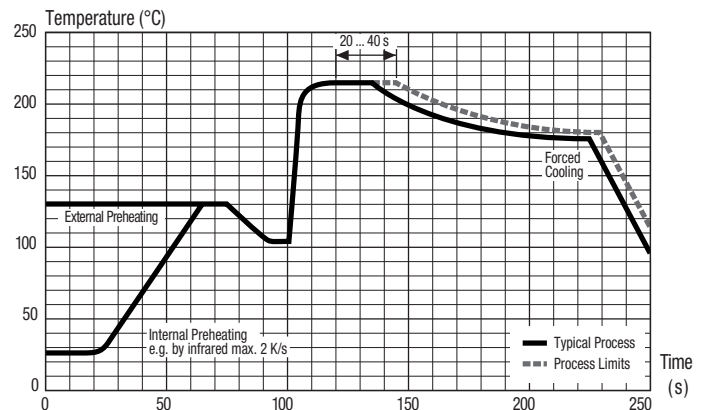

DPM 90 AND DPM 94 VOLTAGE GRADIENTS

Cases	DPM 94 and DPM 94 N					
	50 V	63 V	100 V	200 V	250 V	400 V
	dV / dt (V / μs)					
DPM 94-0	70	95	110	150	170	300
DPM 94-1	40	65	80	120	150	200
DPM 94-2	20	30	40	55	70	100
DPM 94-3	20	30	40	55	70	100
DPM 94-4	15	25	35	45	55	90

For peak to peak voltages lower than rated voltage ($V_{pp} < V_R$), the specified dV / dt can be multiplied by the factor V_R / V_{pp} .

RECOMMENDATIONS FOR USE OF DPM 90 AND DPM 94:

These capacitors are not polarized. However marking shows the + Polarity used during manufacturing and electric tests. It is recommended to continue using this polarity.

GENERAL INFORMATION ON CAPACITORS FOR HIGH FREQUENCY SWITCH MODE POWER SUPPLIES

RESONANT FREQUENCY VS. CAPACITANCE

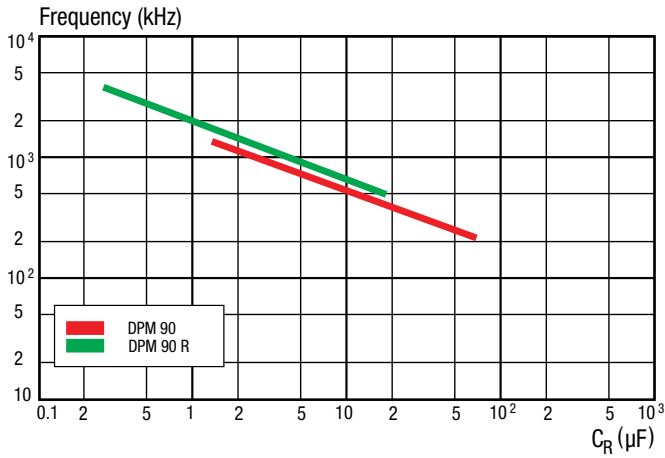

EQUIVALENT SERIES RESISTANCE VS. FREQUENCY

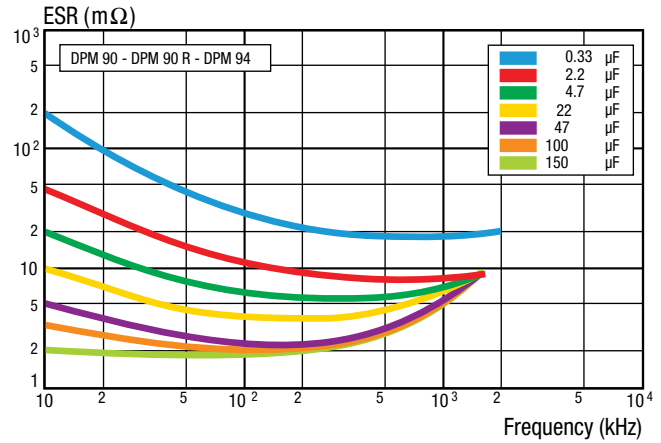

IMPEDANCE VS. FREQUENCY

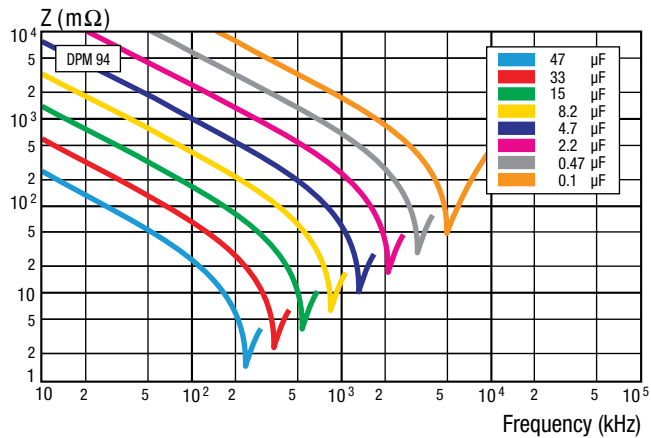

PEAK AC VOLTAGE VS. FREQUENCY (Percent of rated DC voltage)

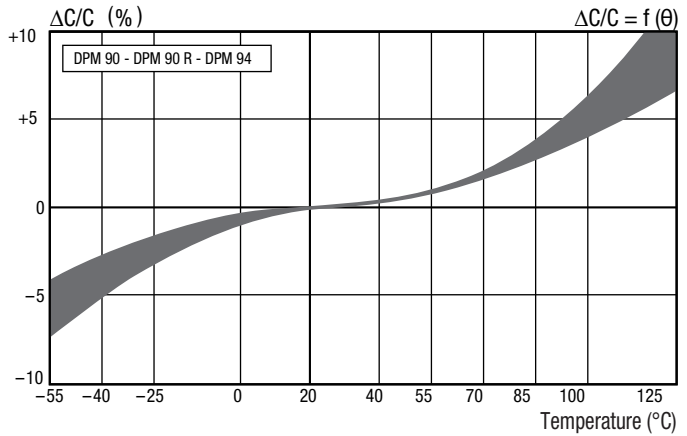

IMPEDANCE VS. FREQUENCY

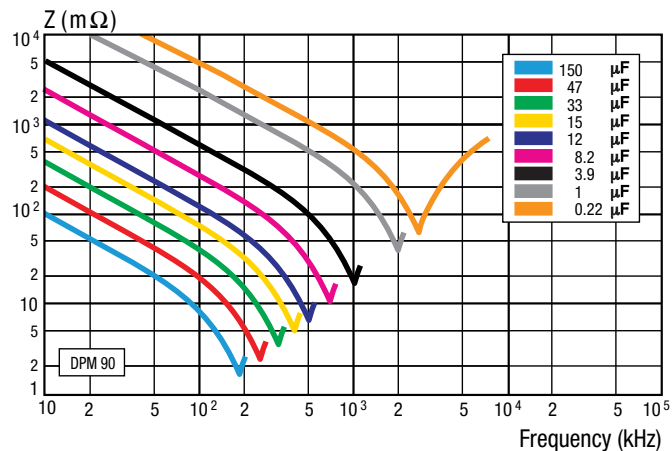

GUIDE TO ORDERING

SECTION GROUNDED TO CASE

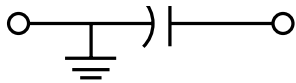

DIMENSIONS (in inches)

CASE STYLE 01

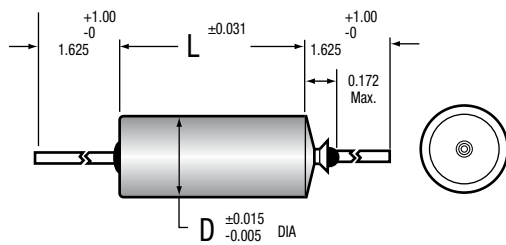

CASE STYLE 03

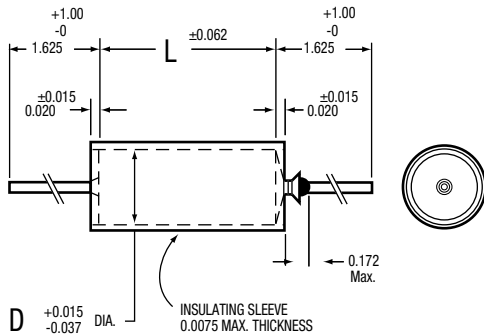

CASE STYLE 12

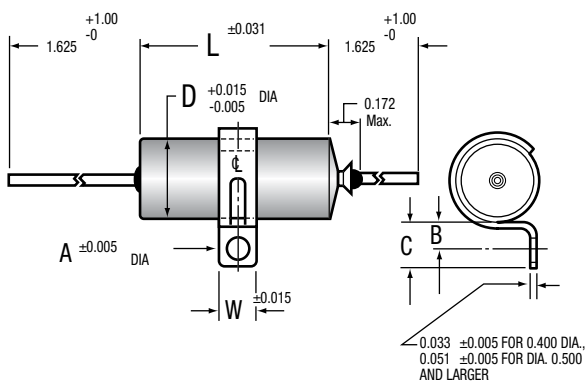

SECTION INSULATED FROM CASE

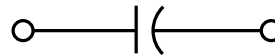

DIMENSIONS (in inches)

CASE STYLE 02

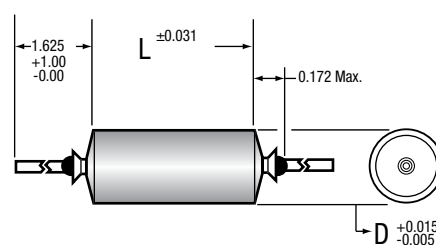

CASE STYLE 04

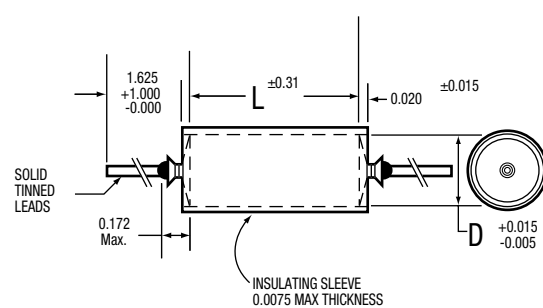

CASE STYLE 13

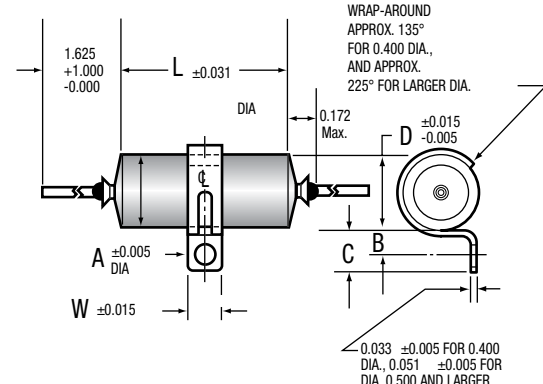

The length of grounded styles is 0.062" shorter than the length shown in tabulations in the catalog.

GUIDE TO ORDERING

BRACKET DIMENSIONS (Style 12 & 13 / in inches)

D	W	A	B	C
0.400	0.250	0.144	0.187±0.015	0.312±0.031
0.500	0.500	0.156	0.250±0.031	0.437±0.062
0.562	0.500	0.156	0.250±0.031	0.437±0.062
0.670	0.500	0.156	0.250±0.031	0.437±0.062
0.750	0.500	0.156	0.250±0.031	0.437±0.062
1.000	0.500	0.156	0.250±0.031	0.437±0.062

*Based on 1 in. = 25.4 mm

TYPICAL TAB TERMINAL DIMENSIONS

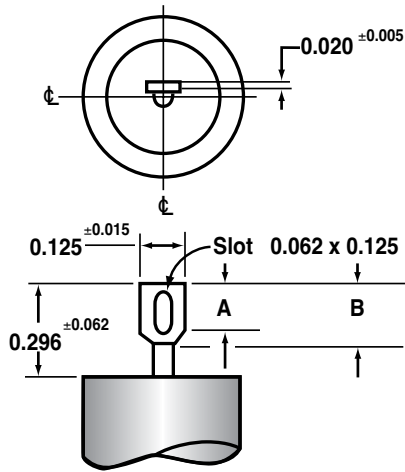

Dwg. No A-9525

A = 0.156 ± 0.015" (3.96 ± 0.38 mm)

B = 0.187 ± 0.015" (4.75 ± 0.38 mm)

Tab Terminal available only on case diameters equal to or greater than 0.400 inches.

T1 & T3 styles are supplied with one tab terminal on the insulated end and a ground lead on the opposite end.

ORDERING TABLES

METAL CASE

EXAMPLE:

218P

223

X9

100

S

02

CATALOG NUMBERING SYSTEM

Case style

Terminal: S = Wire leads T = Soldering tab*.

DC Voltage rating: Expressed in volts.
See standard ratings charts for voltage code.

Capacitance Tolerance: X0 = $\pm 20\%$
X9 = $\pm 10\%$
X5 = $\pm 5\%$
X2 = $\pm 2\%$

Capacitance: Expressed in picofarads, the first two digits are significant figures; the third is the number of zeros following. See standard ratings tables for capacitance code.

Dearborn type number: Identifies the basic capacitor.

* Soldering tabs are available only on case diameters equal to or greater than 0.400 inches.

WRAP AND FILL

EXAMPLE:

430P

183

X9

100

X

F

CATALOG NUMBERING SYSTEM

"F" applies only to "ROHS" compliant parts.

Terminal: No suffix required unless specified on applicable specification sheet (Terminal style).

DC Voltage rating: Expressed in volts.
See standard ratings charts for voltage code.

Capacitance Tolerance: X0 = $\pm 20\%$
X9 = $\pm 10\%$
X5 = $\pm 5\%$
X2 = $\pm 2\%$

Capacitance: Expressed in picofarads, the first two digits are significant figures; the third is the number of zeros following. See standard ratings tables for capacitance code.

Dearborn type number: Identifies the basic capacitor.

ORDERING TABLES

TYPE DPM 90, DPM 90 R1, DPM 90 R2

EXAMPLE:

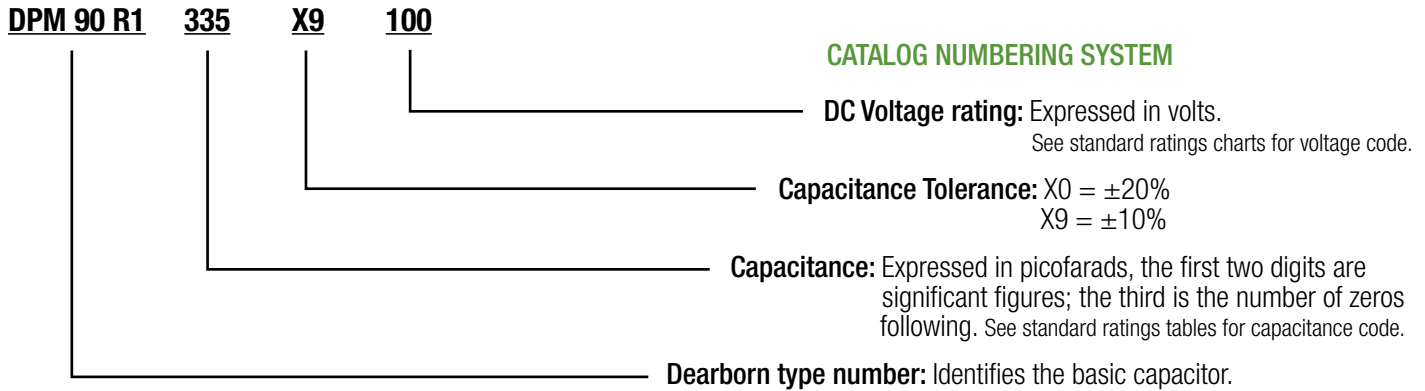

TYPE DPM 94, DPM 94 N, DPM 948

EXAMPLE:

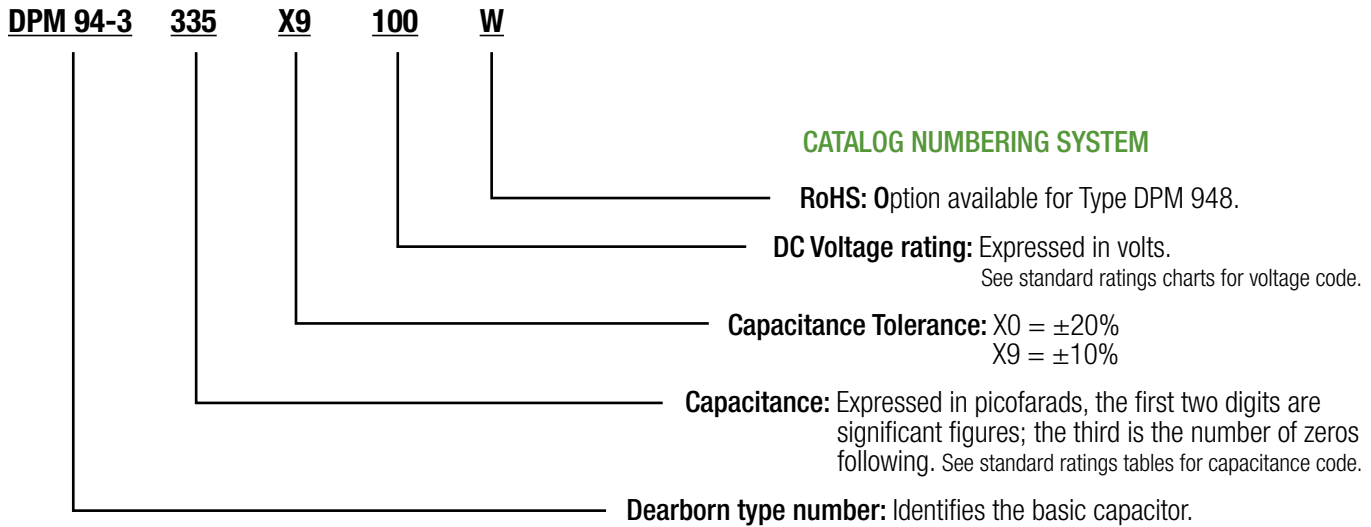

TYPE DPM 907, DPM 907N, DPM 907 R1, DPM 907 R2

EXAMPLE:

DPM 907 R1 336 X9 100 W

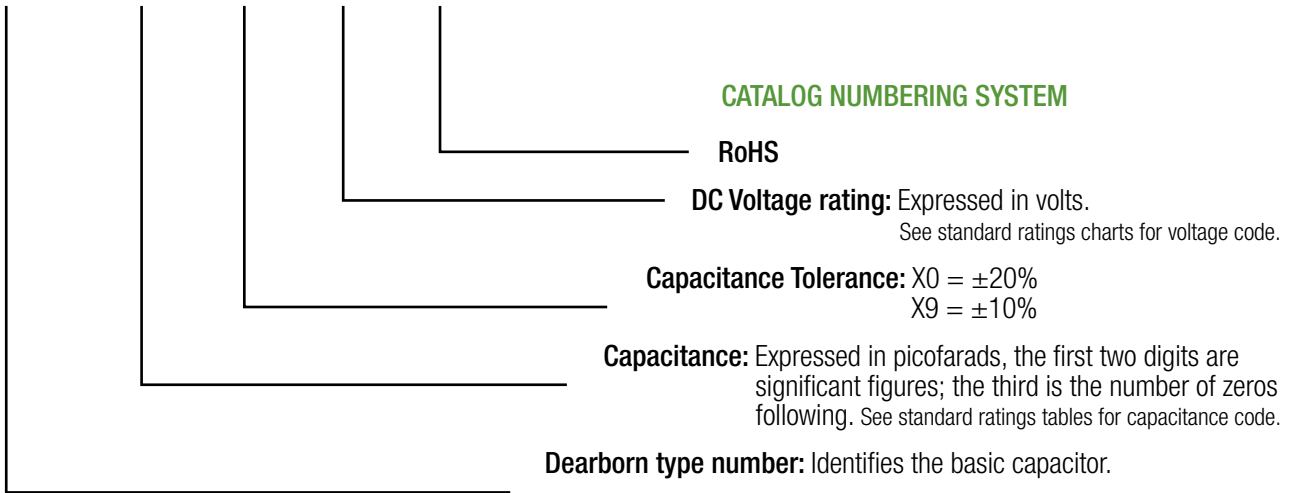

TYPE DKM 94 SMD PPS

EXAMPLE:

DKM94-3 334 X9 100

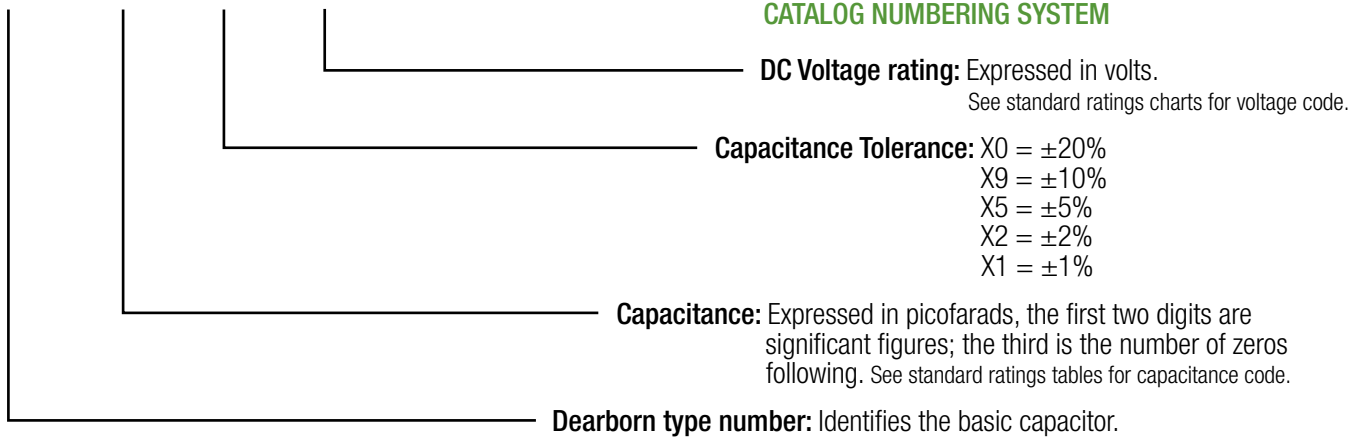

TYPE DHT 96, DHT 78, DHT 78P⁽¹⁾, DHT 86, DHT 86 P⁽¹⁾, DHT 97, DHT 97P⁽¹⁾

EXAMPLE:

DHT 96-6 104 X9 3000

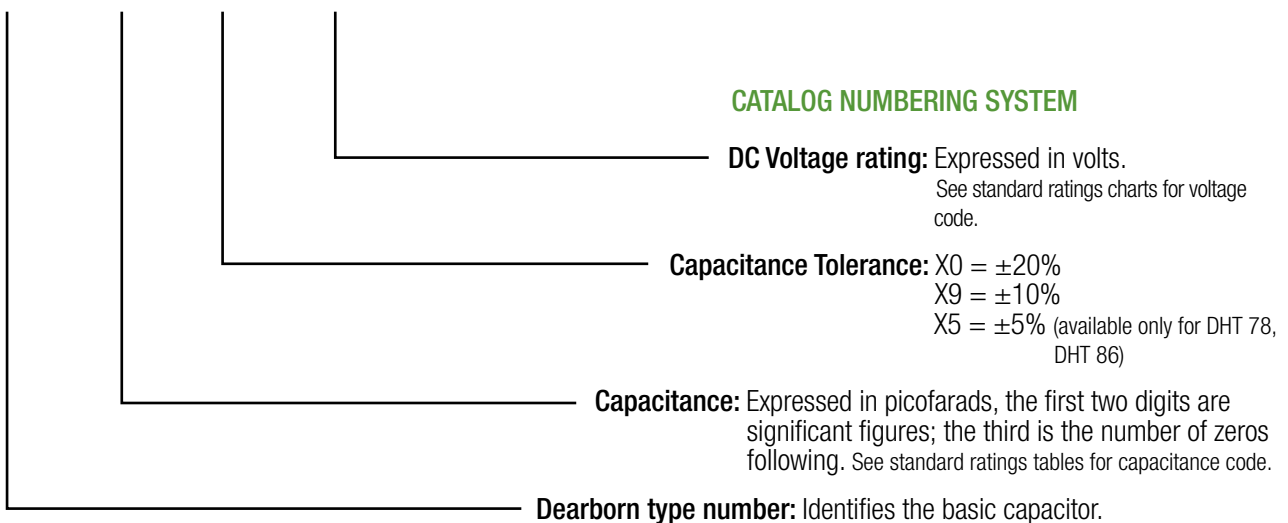

CUSTOM-DESIGNED FILM CAPACITORS

Tailoring of capacitors to meet special requirements for geometry and electrical characteristics is often necessary.

Dearborn Electronic Inc. supplies “special” capacitors utilizing a wide variety of dielectrics in many different mechanical configurations.

CUSTOM DESIGN

Various dielectrics used have been paper, paper-polyester, polyester, polysulfone, polystyrene, polypropylene, TFE fluorocarbon, polyvinylidene, fluoride, and others. Capacitors have been produced using discrete foil and metalized electrode systems. Impregnants employed include mineral oil, wax, Vitamin Q® silicone oil and various so-called solid impregnants.

Capacitor housings include drawn and fabricated metal shells in standard, rectangular, and special shapes, glass and ceramic tubes, cast epoxy housings, molded housings, plastic-film tubes, plastic-film wraps, and epoxy and resin coatings. Where required, special mounting studs and brackets have been furnished.

Capacitance tolerances to meet specific applications needs are available within the limits of the capacitor construction. Units with matched capacitor sections, multiple sections of different dielectrics, pulse forming networks, capacitor networks, capacitor standards, or other application specific capacitors, are available to meet your circuit needs.

Special paper and film-type capacitors have been provided with capacitance ratings from 0.0001 μF to 2000 μF and with voltage ratings from 30 VDC to 30,000 VDC. Capacitors have been supplied to operate over the temperature range of -65°C to $+250^{\circ}\text{C}$.

The rigid quality control exercised by Dearborn Electronics Inc. on all its standard production is also applied to custom-fabricated capacitors. Where necessary, special testing is done to verify requirements, such as low dielectric absorption, ultra-high insulation resistance, low dissipation factor, stability under temperature cycling or under specified environmental conditions, etc.

If you have the need for special capacitor designs utilizing paper or film dielectrics, Dearborn will be glad to make recommendations on how best to meet your application needs.



+250°C FILM CAPACITORS

TYPE 911P



Dearborn's Type 911P capacitors are the answer for design engineers that must resolve problems in systems that need to perform at temperatures beyond ordinary capacitors.

Manufactured from a polymer film that does not melt, and having a glass transition temperature (Tg) of over +320°C, the extraordinary 911P operates at +250°C without voltage de-rating. Packaged with a tape wrap and potting compound especially selected for extreme temperatures, these axial leaded capacitors provide a rugged, robust construction capable of withstanding harsh environments.

With a discrete metal foil termination providing extremely low loss characteristics and capable of withstanding high peak currents, the Type 911P capacitors offer stable capacitance (+/- 10%) from -55°C to +250°C with excellent insulation resistance.

DIMENSIONS (in inches)

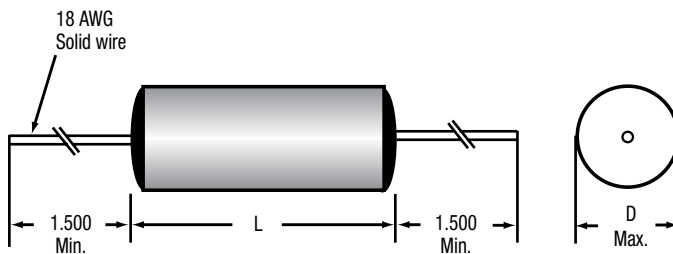

CAPACITANCE CHANGE VS. TEMPERATURE @ 1KHZ

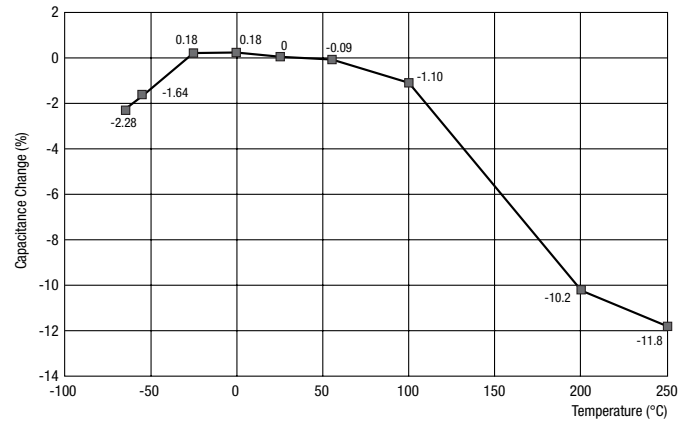

DISSIPATION FACTOR VS. TEMPERATURE

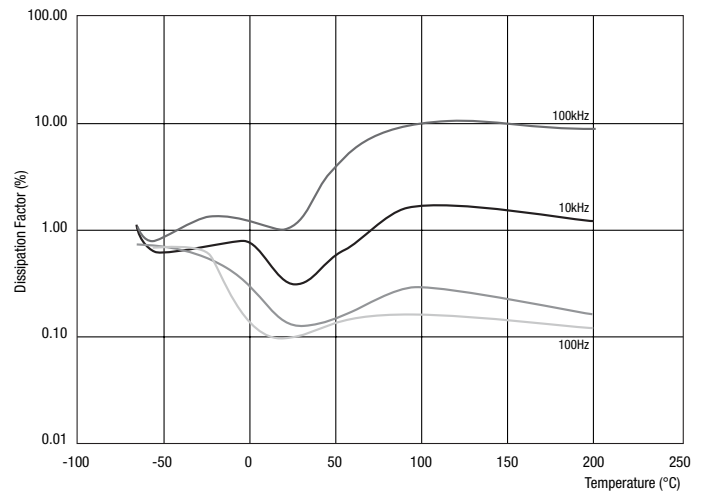

IR VS. TEMPERATURE

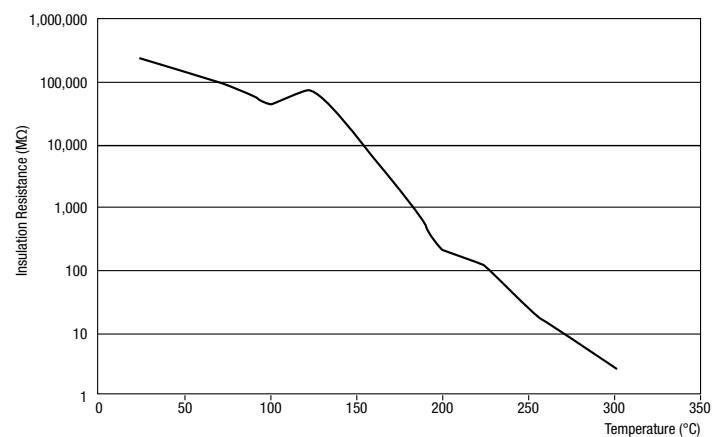

+250°C FILM CAPACITORS

STANDARD RATINGS

Capacitance		Voltage Rating VDC	Diameter "D" Max.	Length L ± 0.062
µF	Code			
0.10	104	400	0.415	1.188
0.12	124	400	0.465	1.188
0.15	154	400	0.515	1.188
0.18	184	400	0.525	1.188
0.20	204	400	0.530	1.188
0.22	224	400	0.627	1.188
0.27	274	400	0.565	1.500
0.33	334	400	0.845	1.500
0.39	394	400	1.015	1.500
0.47	474	400	0.650	1.750
0.50	504	400	0.660	1.750
0.56	564	400	0.695	1.750
0.68	684	400	0.745	1.750
0.82	824	400	0.745	2.000
1.000	105	400	0.815	2.000
1.200	125	400	0.875	2.000
1.500	155	400	0.905	2.188
1.800	185	400	0.985	2.188
2.000	205	400	1.030	2.188
2.200	225	400	1.015	2.500
2.700	275	400	1.115	2.500

CATALOG NUMBERING SYSTEM

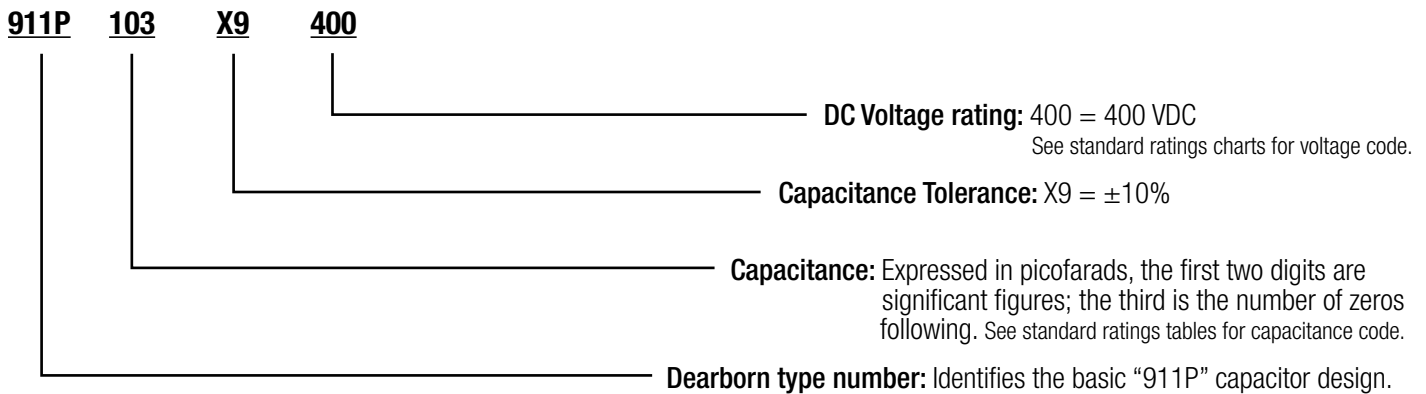

MILITARY APPROVED FILM CAPACITORS

MIL STYLE CAPACITORS

Military style capacitors are manufactured by Dearborn Electronics, Inc. to meet all the requirements of the pertinent military specifications. All capacitors ordered by the military part number will be manufactured, tested and marked in accordance with the military specifications. The military specification shall be used for verification for specific operational parameters and other characteristics.

COPIES OF THE MIL SPECS ARE AVAILABLE:

[www.landandmaritime.dla.mil / Programs / MilSpec / DocSearch.aspx](http://www.landandmaritime.dla.mil/Programs/MilSpec/DocSearch.aspx)

ESTABLISHED RELIABILITY CAPACITORS

The reliability of these capacitors is established by continuous life testing performed at maximum rated voltage and maximum rated temperature. The maximum failure rate at 90% confidence level is expressed as percent failures for each 1,000 hours of test. Dearborn has attained a failure rate level of 0.001% per 1,000 hrs on certain of these specifications. This is the lowest failure rate available for these specifications and the true failure rates are much lower than stated. The failure rate levels attained for each specification are listed on the following page. Failure rate levels are 1% / 1,000 hrs (M), 0.1% / 1,000 hrs (P), 0.01% / 1,000 hrs (R), and 0.001% / 1,000 hrs (S).



MILITARY SPECIFICATION QUALIFICATIONS

Military Specifications	Style	Characteristic / Dielectric	Voltage Rating	Dearborn Type	Remarks	Failure Rate Level	Active / Inactive
C-25 / 4	CP53, 54, 55	E, F, K, Paper & / or Foil Polyester-Foil	100-1000	154P	-	Non ER	A
PRF-11693 / 7	CZ23 / CZ24	E, K, Paper / Foil	100-600	103P	-	Non ER	A
PRF-11693 / 7	CZR23 / CZR24	E, K, Paper / Foil	100-600	103P	-	M	A
C-18312 / 2	CH09	R, N, Paper / Polyester Met.	50-600	218P, 118P	See 39022 / 1	Non ER	I
C-18312 / 3	CH12	N, Paper / Polyester Met.	200-600	118P	See 39022 / 8	Non ER	I
PRF-19978 / 1	CQ08, 9, 12, 13	K, Paper / Polyester-Foil	200-1000	131P	See 19978 / 9, 10, 11	Non ER	I
PRF-19978 / 1	CQ08, 9, 12, 13	M, Polyester-Foil	30-1000	127P	See 19978 / 13, 14, 15	Non ER	I
PRF-19978 / 2	CQ20	K, Paper / Polyester-Foil	1kV-15kV	205P	-	Non ER	A
PRF-19978 / 3	CQ72	E, F, G, Paper / Polyester-Foil K	400-12.5kV	263P	-	Non ER	A / I
PRF-19978 / 9	CQR09	K, Paper / Polyester-Foil	200-1000	131P	-	M, P, R	A
PRF-19978 / 10	CQR12	K, Paper / Polyester-Foil	200-1000	131P	-	M, P, R	A
PRF-19978 / 11	CQR13	K, Paper / Polyester-Foil	200-1000	131P	-	M, P, R	A
C-19978 / 12	CQR19	K, Paper / Polyester-Foil	200-600	131P	See 19978 / 9	M, P, R	I
PRF-19978 / 13	CQR29	M, Polyester / Foil	30-1000	127P	-	M, P, R	A
PRF-19978 / 14	CQR32	M, Polyester / Foil	30-1000	127P	-	M, P, R	A
PRF-19978 / 15	CQR33	M, Polyester / Foil	30-1000	127P	-	M, P, R	A
C-19978 / 16	CQR39	K, Paper / Polyester-Foil	100-1000	131P	See 19978 / 9	M, P, R	I
C-19978 / 17	CQR42	K, Paper / Polyester-Foil	100-1000	131P	See 19978 / 10	M, P, R	I
C-19978 / 18	CQR43	K, Paper / Polyester-Foil	100-1000	131P	See 19978 / 11	M, P, R	I
C-19978 / 19	CQ05	K, Paper / Polyester-Foil	100-1000	131P	See 19978 / 9	M, P, R	I
C-19978 / 20	CQ10	K, Paper / Polyester-Foil	100-1000	131P	See 19978 / 10	M, P, R	I
C-19978-21	CQ11	K, Paper / Polyester-Foil	100-600	131P	See 19978 / 11	M, P, R	I
PRF-19978 / 22	CQR44	U, Polyphenylene Sulfide-Foil	50-600	837P	Replaces / 8	Pending	A
PRF-39022 / 1	CHR09	R, N, Met	50-600	218P, 118P	-	M, P, R	A
PRF-39022 / 2	CHR19	N, Met. Paper & Polyester	200-600	118P	-	M, P, R	A
PRF-39022 / 8	CHR12	R, N, Met. Paper & / or Polyester	50-600	218P, 118P	-	M, P, R	A
PRF-39022 / 12	CHR26	Met. Polyphenylene Sulfide	80-400AC	859P	Replaces / 7	M, P, R, S	A
PRF-39022 / 13	CHR27	Met. Polyphenylene Sulfide	50-600	820P	Replaces / 10	M, P, R, S	A
PRF-55514 / 9	CFR13, 14	L, Met. Polypropylene	100-400	735P	-	M, P	A
PRF-55514 / 10	CFR15	K, Polypropylene-Foil	200-800	710P	-	M, P	A
PRF-55514 / 13	CFR30	Met. Polyphenylene Sulfide	50-200	846P	Replaces / 7	M, P	A
PRF-83421 / 2	CHR11, 12, 13	L, Met. Polypropylene	100-400	720P	-	M, P	A
PRF-84321 / 6	CHR31, 32, 33, 34, 35	Met. Polyphenylene Sulfide	30-400	871P	Replaces / 1	M, P, R, S	A

HERMETICALLY SEALED CAPACITORS

POLYESTER METALIZED FILM CAPACITOR

Type 218P 30

POLYESTER FILM / FOIL CAPACITOR

Type 409P 33

POLYPROPYLENE FILM / FOIL CAPACITOR

Type 700P 35

POLYPHENYLENE SULFIDE FILM CAPACITORS

METALIZED FILM

Type 820P 37

Type 859P 40

Type 860P 42

METALIZED PAPER / POLYESTER FILM CAPACITOR

Type 118P 45

PAPER / FOIL CAPACITOR

Type 103P 48

PAPER / POLYESTER FILM CAPACITORS

Type 131P 50

Type 132P 52

Type CP53 / 54 / 55 54

HIGH VOLTAGE PAPER / POLYESTER FILM CAPACITORS

Type 205P 57

Type CQ72 59



METAL CASE HERMETICALLY-SEALED METALIZED POLYESTER-FILM CAPACITORS



FEATURES

- Small size
- Extensive standard ratings
- Wire leads or tab terminals
- Approved to MIL-PRF-39022

MAJOR APPLICATIONS:

Military and Industrial Applications where light weight and small size are combined with maximum protection against severe environments.

PHYSICAL CHARACTERISTICS

CONSTRUCTION:

Non-inductive wound metalized polyester.

CASE:

Hermetically sealed metal enclosure. Styles and dimensions are in Guide to Ordering section in the front of the catalog.

LEAD MATERIAL:

Leads are solder coated solid wire.

LEAD WIRE SIZES:

Case Dia.	Lead AWG
0.175 and 0.195	No. 24
0.235 and 0.312	No. 22
0.400 and over	No. 20

LEAD STRENGTH:

Capable of withstanding a five pound pull force on lead axis.

MARKING:

Dearborn trademark, type or catalog number, capacitance, tolerance and voltage.

ELECTRICAL SPECIFICATIONS

OPERATING TEMPERATURE:

-55°C to +125°C

CAPACITANCE RANGE:

0.001 μ F to 12.0 μ F

VOLTAGE RANGE:

- 100 VDC to 400 VDC
- 63 VRMS to 200 VRMS

CAPACITANCE TOLERANCE:

\pm 20%, \pm 10%, \pm 5%

VOLTAGE DERATING:

- No derating for DC operation
- For AC operation derate to 70% of the 85°C rating for operation up to 105°C

DISSIPATION FACTOR:

- 0.8% maximum \leq 1.0 μ F
- 1.0% maximum $>$ 1.0 μ F

VOLTAGE TEST:

200% of rated voltage for 2 minutes

INSULATION RESISTANCE:

- At +25°C, 50,000 Megaohm-Microfarads, need not exceed 100,000 Megaohms
- At +85°C, 3,000 Megaohm-Microfarads, need not exceed 6,000 Megaohms
- At +105°C, 250 Megaohm-Microfarads, need not exceed 500 Megaohms
- At +125°C, 10 Megaohm-Microfarads, need not exceed 100 Megaohms

MAXIMUM PULSE RISE TIME

Capacitor Length (inch)	Rise Time dv / dt (V / μ s)			
	100 VDC / 63 VAC	150 VDC / 95 VAC	200 VDC / 125 VAC	400 VDC / 200 VAC
0.750	57	78	135	225
0.875	36	48	51	185
1.125	18	27	31	75
1.375	13	20	24	-
1.625	10	15	19	48
1.875	9	14	15	30
2.125	-	10	-	25
2.375	6	9	12	-
2.625	-	7	10	21

METAL CASE HERMETICALLY-SEALED METALIZED POLYESTER-FILM CAPACITORS

TYPE 218P

STANDARD RATINGS

Capacitance		Voltage Code 100 100 VDC / 63 VAC*		Voltage Code 150 150 VDC / 95 VAC*		Voltage Code 200 200 VDC / 125 VAC*		Voltage Code 400 400 VDC / 200 VAC*	
µF	Code	D	L	D	L	D	L	D	L
0.0010	102	-	-	-	-	0.175	0.750	-	-
0.0015	152	-	-	-	-	0.175	0.750	-	-
0.0022	222	-	-	-	-	0.175	0.750	-	-
0.0033	332	-	-	-	-	0.175	0.750	-	-
0.0047	472	-	-	-	-	0.175	0.750	0.235	0.750
0.0068	682	-	-	-	-	0.175	0.750	0.235	0.750
0.010	103	0.175	0.750	0.175	0.750	0.175	0.750	0.235	0.750
0.015	153	0.175	0.750	0.175	0.750	0.175	0.750	0.312	0.875
0.022	223	0.175	0.750	0.195	0.750	0.195	0.750	0.312	0.875
0.033	333	0.175	0.750	0.195	0.750	0.235	0.750	0.312	0.875
0.047	473	0.195	0.750	0.235	0.750	0.235	0.750	0.400	0.875
0.068	683	0.235	0.750	0.235	0.750	0.312	0.875	0.400	1.125
0.10	104	0.235	0.750	0.312	0.875	0.312	0.875	0.400	1.125
0.15	154	0.312	0.875	0.312	0.875	0.312	0.875	0.500	1.125
0.22	224	0.312	0.875	0.312	0.875	0.400	0.875	0.562	1.125
0.33	334	0.312	0.875	0.312	1.125	0.400	1.125	0.562	1.625
0.47	474	0.312	1.125	0.400	1.125	0.400	1.375	0.562	1.875
0.68	684	0.400	1.125	0.400	1.125	0.500	1.125	0.670	1.875
1.00	105	0.400	1.125	0.500	1.125	0.562	1.375	0.750	2.125
1.50	155	0.500	1.125	0.562	1.125	0.562	1.625	0.750	2.625
2.00	205	0.562	1.125	0.562	1.375	0.562	1.875	1.000	2.125
2.50	255	0.562	1.375	0.562	1.625	0.670	1.625	1.000	2.625
3.00	305	0.562	1.375	0.670	1.375	0.670	1.875	-	-
4.00	405	0.562	1.625	0.670	1.625	0.750	1.875	-	-
5.00	505	0.562	1.875	0.670	1.875	0.750	2.375	-	-
6.00	605	0.670	1.625	0.750	1.875	0.750	2.625	-	-
7.00	705	0.670	1.875	0.750	2.125	1.000	1.875	-	-
10.00	106	0.750	1.875	0.750	2.625	1.000	2.375	-	-
12.00	126	0.750	2.375	1.000	1.875	1.000	2.625	-	-

Additional capacitance values, voltages, and tolerances are available upon request.

The dimensions shown are for style O2. The dimensions for other styles are included in the general section.

* AC voltage rating is at 60Hz. 1.4 x VRMS + VDC should not exceed the rated VDC.

* Graphs of AC voltage vs frequency follow.

METAL CASE HERMETICALLY-SEALED METALIZED POLYESTER-FILM CAPACITORS

VOLTAGE VS. FREQUENCY TYPE 218P

100 VDC / 63 VAC

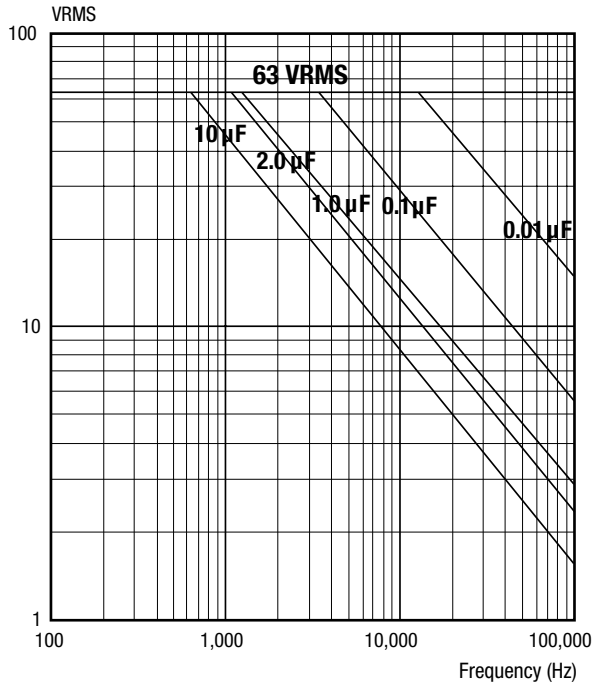

VOLTAGE VS. FREQUENCY TYPE 218P

150 VDC / 95 VAC

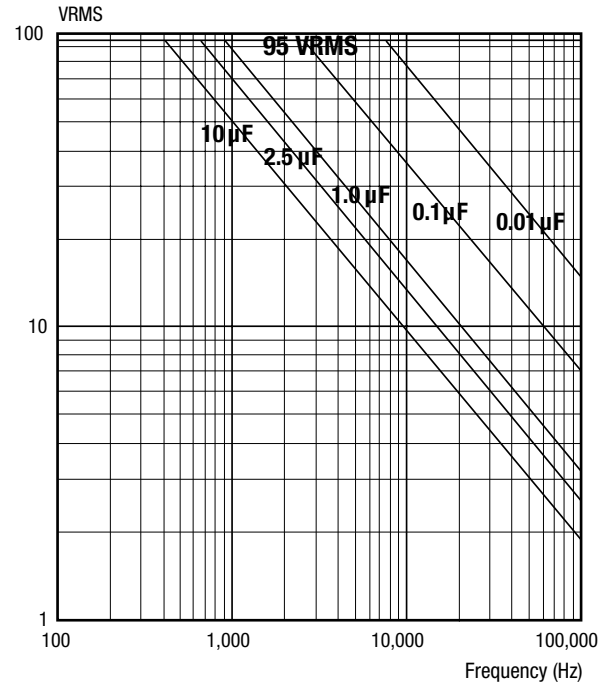

VOLTAGE VS. FREQUENCY TYPE 218P

200 VDC / 125 VAC

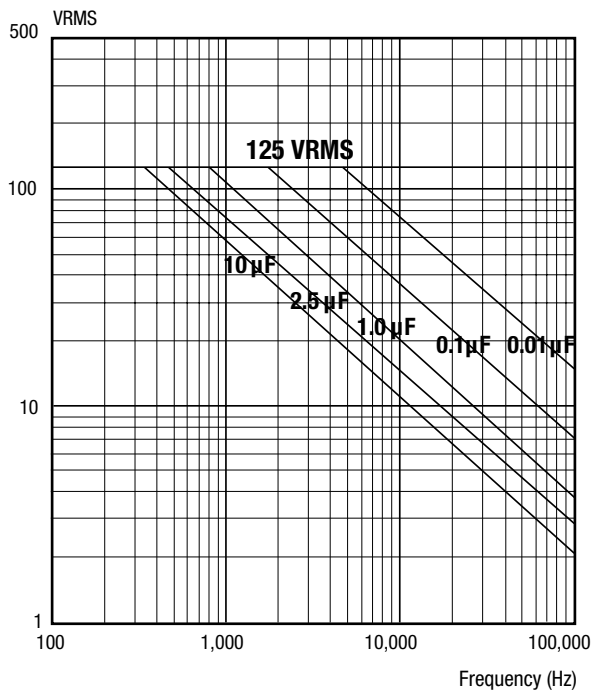

VOLTAGE VS. FREQUENCY TYPE 218P

400 VDC / 200 VAC

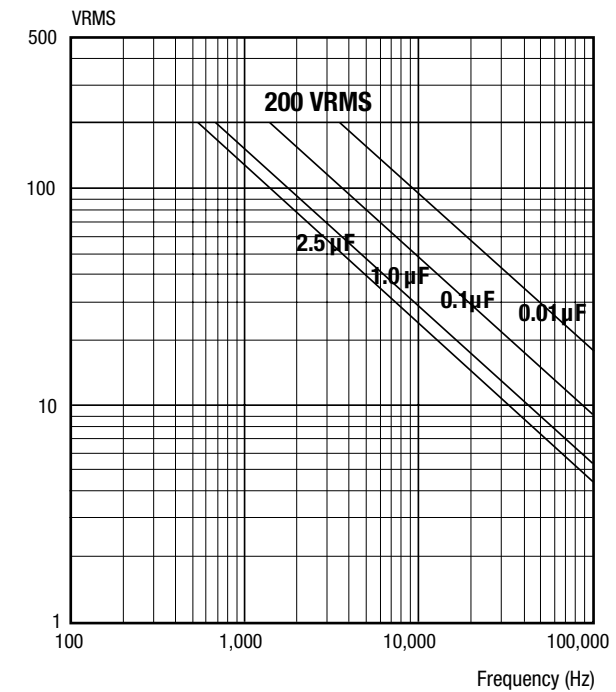

METAL CASE HYPASS™ INTERFERENCE SUPPRESSION POLYESTER FILM CAPACITORS

TYPE 409P

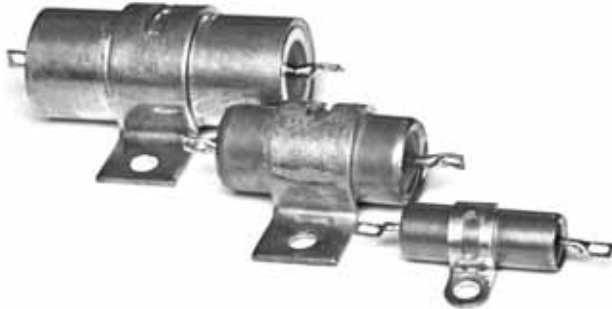

FEATURES

- High frequency filtering
- No series resonance
- Low inductance to ground

MAJOR APPLICATIONS: EMI suppression.

PHYSICAL CHARACTERISTICS

TORQUE: Terminals shall withstand 10 inch pounds with no damage.

DIMENSIONS: See chart below, contact factory for additional sizes.

MARKING:

Dearborn trademark, type or catalog number, capacitance, and voltage.

ENVIRONMENTAL CHARACTERISTICS

DC LIFE TEST:

- 150% of rated DC voltage for 250 hours at +85°C.
- No open or short circuits.
- No visible damage: Max. Cap chg: ±5%
Min. I.R. = 50% of initial limit
Max. D.F. = 2.0%

THERMAL SHOCK AND IMMERSION CYCLING:

No visible damage: Max. Cap chg: ±5%
Min. I.R. = 50% of initial limit
Max. D.F. = 2.0%

ELECTRICAL SPECIFICATIONS

CAPACITANCE RANGE: 0.10 µF to 0.5 µF

DC VOLTAGE RATING: 50 VDC to 1,000 VDC

CAPACITANCE TOLERANCE: +20% - 10%, ±10%

OPERATING TEMPERATURE: -40°C to +85°C

DISSIPATION FACTOR: 1.0% maximum

VOLTAGE TEST: 200% of rated voltage for 1 minute

INSULATION RESISTANCE:

- At +25°C, 20,000 Megaohm-Microfarads, need not exceed 20,000 Megaohms
- At +85°C, 200 Megaohm-Microfarads, need not exceed 1,000 Megaohms

TYPICAL SIZES

Current µF in Amps	Bracket mounting Dimensions						Fig.	
	D	L	W	M	R	Y		
50 WVDC								
0.50	40	1.000	1.813	1.000	0.875	1.188	0.250	1
0.50	60	1.000	1.813	1.000	0.875	1.188	0.250	1
200 WVDC								
0.25	20	0.750	1.813	0.750	0.656	0.875	0.201	1
0.50	20	1.000	1.813	1.000	0.875	1.188	0.250	1
400 WVDC								
0.10	20	0.688	1.813	0.750	0.641	0.781	0.201	1
600 WVDC								
0.10	20	0.688	1.813	0.750	0.641	0.781	0.201	1
0.25	20	1.000	1.813	1.000	0.875	1.188	0.250	1
0.50	20	1.000	2.250	1.000	0.875	1.188	0.250	1

Current µF in Amps	Bulkhead mounting Dimensions						Fig.	
	D	L	W	M	R	Y		
200 WVDC								
0.25	20	0.750	1.813	0.875	1.125	1.438	0.156	2
400 WVDC								
0.10	20	0.688	1.813	0.875	1.062	1.375	0.156	2
600 WVDC								
0.10	20	0.688	1.813	0.875	1.062	1.375	0.156	2
0.50	100	1.125	3.125	1.500	1.750	2.312	0.201	3
1,000 WVDC								
0.20	100	1.125	3.125	1.500	1.750	2.312	0.201	3

Note:

Hypass capacitors rated at 200 WVDC or 400 WVDC may be used on 130 volt, 60Hz circuits. Capacitors rated at 600 and 1,000 WVDC may be used on 250 volt, 60Hz circuits.

INSERTION LOSS OF A HYPASS™ CAPACITOR VS. A CONVENTIONAL CAPACITOR

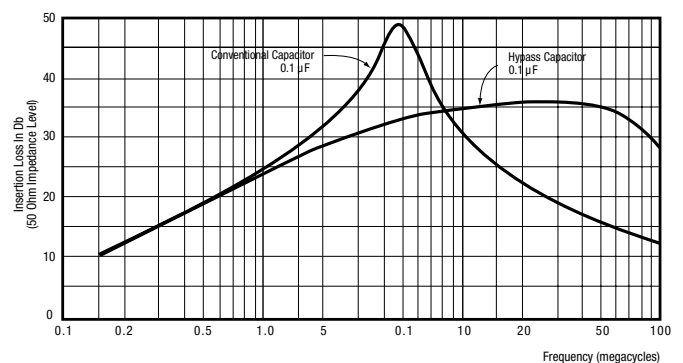

METAL CASE HERMETICALLY SEALED TUBULAR POLYPROPYLENE FILM / FOIL CAPACITORS

TYPE 700P



FEATURES

- High stability
- High insulation resistance
- Low series resistance
- Low losses
- Low dielectric absorption
- Excellent AC performance
- Hermetically sealed

MAJOR APPLICATIONS:

High current and high pulse operations, protection circuits in SMPS, snubber and SCR commutating circuits, oscillator, timing and filter circuits, high frequency coupling and other applications where severe environments require hermetically sealed cases.

PHYSICAL CHARACTERISTICS

CONSTRUCTION:

Polypropylene film extended aluminum foil.

CASE:

Hermetically sealed metal enclosure. Styles and dimensions are in Guide to Ordering section in the front of the catalog.

LEAD MATERIAL:

Solder coated copper wire.

LEAD WIRE SIZES:

Case Dia.	Lead AWG
0.400 - 0.500	No. 20
0.562 and over	No. 18

LEAD PULL: 5 lbs (2.3 kg) for one minute. No physical damage.

LEAD BEND: After three complete consecutive bends. No damage.

MARKING:

Dearborn trademark, type or catalog number, capacitance, tolerance and voltage.

ELECTRICAL SPECIFICATIONS

CAPACITANCE RANGE:

0.01 μ F to 1.0 μ F

VOLTAGE RATING:

- 200 VDC to 800 VDC
- 155 VRMS to 500 VRMS

CAPACITANCE TOLERANCE:

\pm 20%, \pm 10%, \pm 5%

OPERATING TEMPERATURE:

-55°C to +105°C

VOLTAGE DERATING:

- At +105°C, 70% of the 85° rating for DC applications
- For AC applications above 85°C, see Table 1

DISSIPATION FACTOR:

0.1% maximum

DC VOLTAGE TEST:

250% of rated voltage for 5 seconds

INSULATION RESISTANCE:

Measured at rated VDC after a 2 minute test.

- At +25°C, 200,000 Megaohm Microfarads, need not exceed 400,000 Megaohms
- At +85°C, 10,000 Megaohm-Microfarads, need not exceed 20,000 Megaohms
- At +105°C, 1,000 Megaohm-Microfarads, need not exceed 2,000 Megaohms

MAXIMUM PULSE RISE TIME

Capacitor Length (inch)	Rise Time dv / dt (V / μ s)			
	200 VDC	400 VDC	600 VDC	800 VDC
0.875	1000	1800	3000	-
1.062	700	1000	2000	-
1.125	-	-	-	2500
1.375	450	650	1000	1500
1.750	400	500	700	1000
2.125	-	400	600	800

METAL CASE HERMETICALLY SEALED TUBULAR POLYPROPYLENE FILM / FOIL CAPACITORS

TABLE 1: AC VOLTAGE RATINGS

Capacitance Range	EQUIVALENT VAC RATINGS										Max. AC Life Test Voltage (RMS)
	1,000Hz		5,000Hz		10,000Hz		15,000Hz		20,000Hz		
	85°C	105°C	85°C	105°C	85°C	105°C	85°C	105°C	85°C	105°C	
200 V											
0.047 - 0.068	155	75	115	75	85	60	70	50	60	45	155
0.082 - 0.47	155	75	75	60	55	40	45	35	40	30	155
0.68 - 1.0	155	75	75	50	55	30	45	20	40	15	155
400 V											
0.033	200	100	190	100	135	105	110	85	95	75	200
0.039 - 0.47	200	100	100	80	75	55	60	45	50	40	200
0.68 - 1.0	200	100	100	50	75	30	60	20	50	15	200
600 V											
0.001 - 0.033	240	165	240	200	190	140	155	120	130	100	240
0.039 - 0.22	240	165	150	115	100	75	90	65	75	50	240
0.27 - 0.47	240	120	150	65	100	35	90	25	70	15	240
800 V											
0.0056 - 0.033	500	250	500	190	500	150	450	120	405	100	500
0.039 - 0.10	500	250	400	120	240	100	185	75	140	60	500
0.12 - 0.33	500	195	280	75	160	45	115	30	85	20	500

STANDARD RATINGS

Capacitance		Voltage Code 200 200 VDC / 155 VAC*		Voltage Code 400 400 VDC / 200 VAC*		Voltage Code 600 600 VDC / 240 VAC*		Voltage Code 800 800 VDC / 500 VAC*	
µF	Code	D	L	D	L	D	L	D	L
0.010	103	-	-	-	-	0.400	0.875	0.400	1.125
0.015	153	-	-	-	-	0.400	0.875	0.500	1.125
0.022	223	-	-	-	-	0.400	1.062	0.500	1.125
0.033	333	-	-	0.400	0.875	0.500	1.062	0.500	1.375
0.047	473	0.400	0.875	0.400	1.062	0.500	1.375	0.562	1.375
0.068	683	0.400	1.062	0.500	1.062	0.562	1.375	0.670	1.375
0.10	104	0.400	1.062	0.500	1.375	0.670	1.375	0.670	1.750
0.15	154	0.500	1.062	0.562	1.375	0.670	1.750	0.750	1.750
0.22	224	0.500	1.375	0.670	1.375	0.750	1.750	1.000	1.750
0.33	334	0.670	1.375	0.750	1.750	1.000	1.750	1.000	2.125
0.47	474	0.670	1.750	0.750	1.750	1.000	2.125	-	-
0.68	684	0.750	1.750	1.000	1.750	-	-	-	-
1.00	105	1.000	1.750	1.000	2.125	-	-	-	-

Additional capacitance values, voltages, and tolerances are available upon request.

* 1.4 x VRMS + VDC should not exceed the rated VDC.

* See Table 1 for AC voltage vs frequency and temperature.

400 and 600 VAC parts are available upon request.

METALIZED POLYPHENYLENE SULFIDE METAL-CASE TUBULAR METALIZED PPS FILM CAPACITORS

TYPE 820P



FEATURES

- Superior performance, polycarbonate replacement
- High current
- High Q, low TCC
- High reliability
- Rugged construction
- Small size
- Hermetically sealed
- Meets the requirements of MIL-PRF-39022 / 13

MAJOR APPLICATIONS:

Storage, filtering, timing, integrating, and applications where severe environments require hermetically sealed cases.

PHYSICAL CHARACTERISTICS

CONSTRUCTION:

Non-inductive wound metalized polyphenylene sulfide.

CASE:

Hermetically sealed metal enclosure. Styles and dimensions are in Guide to Ordering section in the front of the catalog.

LEAD MATERIAL:

Solder coated solid wire.

LEAD WIRE SIZES:

Case Dia.	Lead AWG	Case Dia.	Lead AWG
0.175 and 0.195	No. 24	0.235 and 0.312	No. 22
0.400 thru 0.750	No. 20	1.000	No. 18

LEAD PULL: 5 lbs (2.3 kg) for one minute. No physical damage.

LEAD BEND: After three complete consecutive bends. No damage.

MARKING:

Dearborn trademark, type or catalog number, capacitance, tolerance and voltage.

ELECTRICAL SPECIFICATIONS

CAPACITANCE RANGE:

0.01 μ F to 15.0 μ F

DC VOLTAGE RANGE:

50 VDC to 400 VDC

AC VOLTAGE RANGE:

32 to 240 VRMS

CAPACITANCE TOLERANCE:

\pm 10%, \pm 5%, \pm 2%, \pm 1%

OPERATING TEMPERATURE:

- -55°C to +125°C
- AC operation limited to +105°C

VOLTAGE DERATING:

- At +105°C, 70% of the rating
- At +125°C, 50% of the rating

DISSIPATION FACTOR:

0.15% maximum when measured @ 1kHz @ 25°C

VOLTAGE TEST:

200% of rated voltage for 2 minutes

INSULATION RESISTANCE:

Measured at rated VDC after a 2 minute charge.

- At +25°C, 100,000 Megaohm-Microfarads, need not exceed 200,000 Megaohms
- At +85°C, 6,000 Megaohm-Microfarads, need not exceed 25,000 Megaohms
- At +125°C, 1,000 Megaohm-Microfarads, need not exceed 15,000 Megaohms

MAXIMUM PULSE RISE TIME

Capacitor Length (inch)	Rise Time dv / dt (V / μ s)			
	50 V	100 V	200 V	400 V
0.531	24	-	-	-
0.625	13	27	55	-
0.688	-	20	36	80
0.812	-	17	27	60
0.843	8	-	-	-
0.938	-	13	22	44
1.125	4	10	13	-
1.312	3	7	12	24
1.562	-	5	9	19
1.625	-	-	-	-
1.812	-	4	7	13
1.875	-	-	-	-
2.062	-	-	6	10

METALIZED POLYPHENYLENE SULFIDE METAL-CASE TUBULAR METALIZED PPS FILM CAPACITORS

STANDARD RATINGS

Capacitance		Voltage Code 050 50 VDC / 32 VAC*		Voltage Code 100 100 VDC / 63 VAC*		Voltage Code 200 200 VDC / 126 VAC*		Voltage Code 400 400 VDC / 240 VAC*	
μF	Code	D	L	D	L	D	L	D	L
0.010	103	-	-	0.174	0.625	0.174	0.625	0.235	0.688
0.015	153	-	-	0.174	0.625	0.174	0.625	0.235	0.812
0.022	223	-	-	0.174	0.625	0.193	0.625	0.312	0.688
0.033	333	-	-	0.174	0.625	0.235	0.625	0.312	0.812
0.047	473	0.174	0.531	0.193	0.625	0.235	0.688	0.400	0.812
0.068	683	0.174	0.625	0.235	0.625	0.312	0.625	0.400	0.938
0.10	104	0.174	0.625	0.235	0.688	0.312	0.688	0.400	1.125
0.15	154	0.193	0.625	0.312	0.625	0.312	0.812	0.400	1.312
0.22	224	0.235	0.625	0.312	0.688	0.400	0.812	0.562	1.125
0.33	334	0.312	0.625	0.312	0.812	0.400	0.938	0.562	1.562
0.47	474	0.312	0.625	0.400	0.688	0.400	1.125	0.562	1.812
0.68	684	0.312	0.843	0.400	0.812	0.500	1.125	0.670	1.812
1.00	105	0.312	0.843	0.400	0.938	0.562	1.125	0.750	2.062
1.50	155	0.400	0.843	0.500	0.938	0.562	1.312	1.000	1.812
2.00	205	0.400	0.843	0.500	1.125	0.562	1.812	1.000	2.062
2.70	275	0.400	1.125	0.562	1.312	0.670	1.562	-	-
3.00	305	0.400	1.125	0.562	1.312	0.750	1.562	-	-
4.00	405	0.500	1.125	0.562	1.562	0.750	1.812	-	-
5.00	505	0.500	1.125	0.670	1.312	0.750	2.062	-	-
6.80	685	0.562	1.125	0.670	1.562	-	-	-	-
8.20	825	0.562	1.312	0.670	1.812	-	-	-	-
10.00	106	0.670	1.312	0.750	1.812	-	-	-	-
12.00	126	0.670	1.312	-	-	-	-	-	-
15.00	156	0.750	1.375	-	-	-	-	-	-

Additional capacitance values, voltages, and tolerances are available upon request.

* AC voltage rating is at 400Hz. $1.4 \times V_{RMS} + VDC$ should not exceed the rated VDC.

* Graphs of AC voltage vs. frequency follow.

The dimensions shown above are for styles 02, 04 and 13. The dimensions for other styles are included in the general section in the front of the catalog.

METALIZED POLYPHENYLENE SULFIDE METAL-CASE TUBULAR METALIZED PPS FILM CAPACITORS

TYPE 820P

VOLTAGE VS. FREQUENCY TYPE 820P
50 VDC / 32 VAC

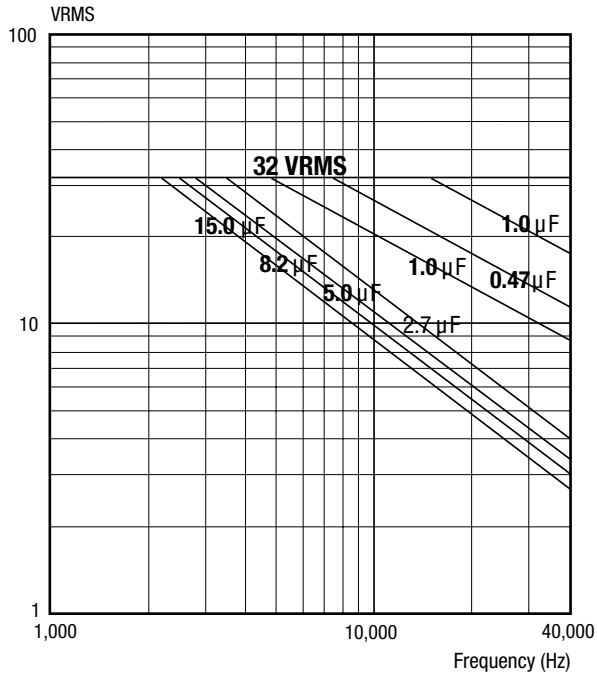

VOLTAGE VS. FREQUENCY TYPE 820P
100 VDC / 63 VAC

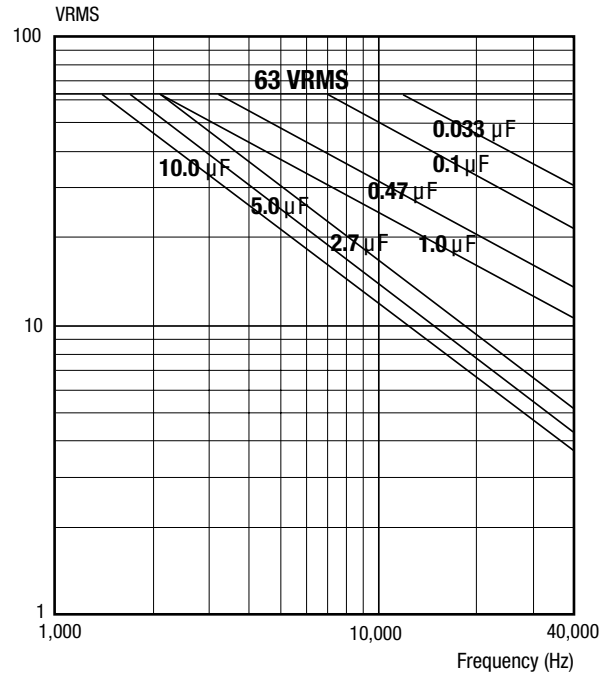

VOLTAGE VS. FREQUENCY TYPE 820P
200 VDC / 126 VAC

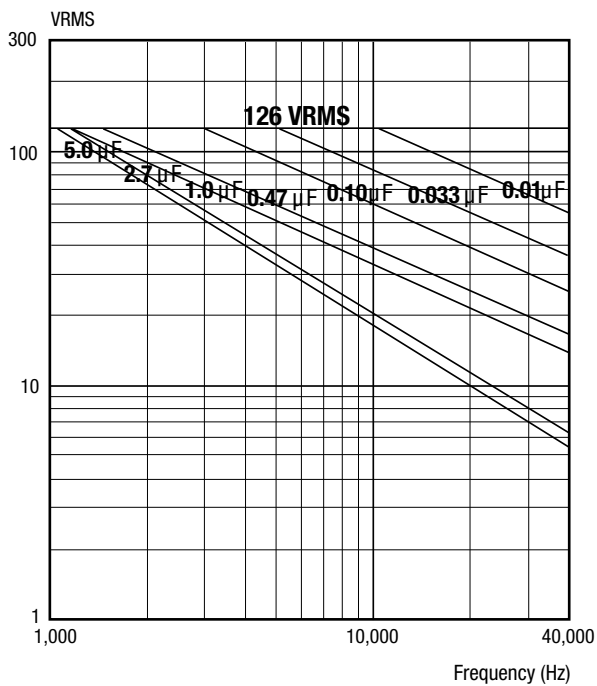

VOLTAGE VS. FREQUENCY TYPE 820P
400 VDC / 240 VAC

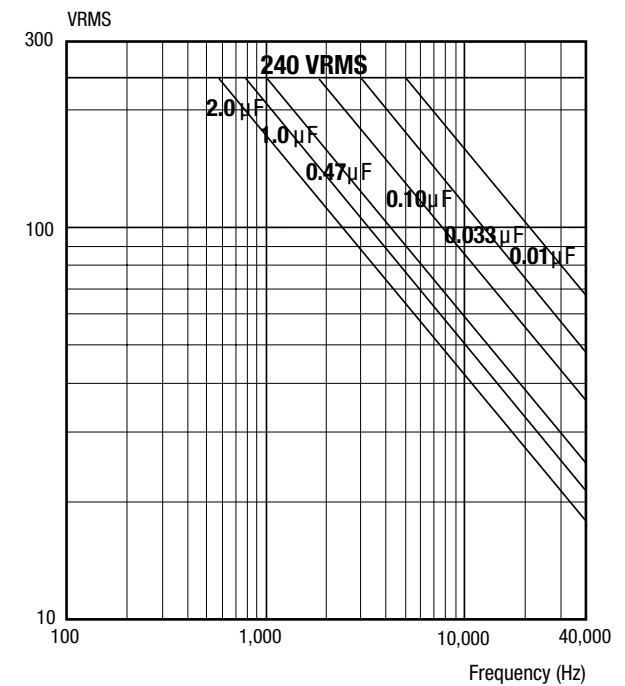

METAL-CASE HERMETICALLY-SEALED AC RATED METALIZED POLYPHENYLENE SULFIDE FILM CAPACITORS



FEATURES

- Full rating at 85°C and 400Hz
- High stability, polycarbonate replacement
- Small size
- Low power dissipation
- Low dielectric absorption
- Meets the requirements of MIL-PRF-39022 / 12

MAJOR APPLICATIONS:

Motor run, speed control, filtering.

PHYSICAL CHARACTERISTICS

CONSTRUCTION:

Non-inductive wound metalized polyphenylene sulfide.

CASE:

Hermetically sealed metal enclosure. Styles and dimensions are in Guide to Ordering section in the front of the catalog.

LEAD MATERIAL:

Solder coated solid wire.

LEAD WIRE SIZES:

Case Dia.	Lead AWG
0.312	No. 20
0.400 and over	No. 18

LEAD PULL:

5 lbs (2.3 kg) for one minute. No physical damage.

LEAD BEND:

After three complete consecutive bends. No damage.

MARKING:

Dearborn trademark, type or catalog number, capacitance, tolerance and voltage.

ELECTRICAL SPECIFICATIONS

CAPACITANCE RANGE:

0.01 μ F to 10.0 μ F

AC VOLTAGE RANGE:

80 VRMS to 440 VRMS at 400Hz

CAPACITANCE TOLERANCE:

\pm 20%, \pm 10%, \pm 5%

OPERATING TEMPERATURE:

-55°C to +105°C

VOLTAGE DERATING:

At +105°C, 70% of +85°C rating

DISSIPATION FACTOR:

0.15% maximum when measured at 1kHz @ 25°C

AC VOLTAGE TEST:

140% of rated voltage for 2 minutes

INSULATION RESISTANCE:

Measurements made after a 2 minute charge at 200 VDC for AC ratings equal to or less than 330 VRMS and at 400 VDC for AC ratings greater than 330 VRMS.

- At +25°C, 50,000 Megaohm-Microfarads, need not exceed 100,000 Megaohms
- At +85°C, 10,000 Megaohm-Microfarads, need not exceed 50,000 Megaohms
- At +105°C, 2,000 Megaohm-Microfarads, need not exceed 10,000 Megaohms

METAL-CASE HERMETICALLY-SEALED AC RATED METALIZED POLYPHENYLENE SULFIDE FILM CAPACITORS

TYPE 859P

STANDARD RATINGS

Capacitance		Low Voltage Range 80 VRMS to 165 VRMS				Intermediate Voltage Range				High Voltage Range 390 VRMS to 440 VRMS			
µF	Code	400Hz VRMS 85°C	Voltage Code	Inches		400Hz VRMS 85°C	Voltage Code	Inches		400Hz VRMS 85°C	Voltage Code	Inches	
				D	L*			D	L*			D	L*
0.010	103	-	-	-	-	330	330	0.312	0.875	440	440	0.312	1.125
0.012	123	-	-	-	-	330	330	0.400	0.875	440	440	0.400	1.125
0.015	153	-	-	-	-	330	330	0.400	0.875	440	440	0.400	1.125
0.018	183	-	-	-	-	330	330	0.400	0.875	440	440	0.400	1.125
0.022	223	-	-	-	-	330	330	0.400	0.875	440	440	0.400	1.125
0.027	273	-	-	-	-	330	330	0.400	1.125	440	440	0.400	1.375
0.033	333	-	-	-	-	330	330	0.400	1.125	440	440	0.400	1.375
0.039	393	165	165	0.312	0.875	330	330	0.400	1.125	440	440	0.562	1.125
0.047	473	165	165	0.312	0.875	330	330	0.400	1.125	440	440	0.562	1.125
0.056	563	165	165	0.312	0.875	330	330	0.400	1.375	440	440	0.562	1.375
0.068	683	165	165	0.312	0.875	330	330	0.400	1.375	440	440	0.562	1.375
0.082	823	165	165	0.312	0.875	330	330	0.500	1.125	440	440	0.562	1.625
0.10	104	165	165	0.312	0.875	330	330	0.500	1.125	440	440	0.562	1.625
0.12	124	165	165	0.312	1.125	330	330	0.562	1.375	435	435	0.670	1.625
0.15	154	165	165	0.312	1.125	330	330	0.562	1.375	435	435	0.670	1.625
0.18	184	165	165	0.400	0.875	330	330	0.562	1.625	430	430	0.670	1.875
0.22	224	165	165	0.400	0.875	330	330	0.562	1.625	430	430	0.670	1.875
0.27	274	165	165	0.400	1.125	330	330	0.562	1.875	425	425	0.750	2.375
0.33	334	165	165	0.400	1.125	330	330	0.562	1.875	425	425	0.750	2.375
0.39	394	165	165	0.400	1.375	330	330	0.670	1.625	410	410	1.000	1.875
0.47	474	165	165	0.400	1.375	330	330	0.670	1.625	410	410	1.000	1.875
0.56	564	165	165	0.562	1.125	320	320	0.750	1.875	390	390	1.000	2.375
0.68	684	165	165	0.562	1.125	320	320	0.750	1.875	390	390	1.000	2.375
0.82	824	165	165	0.562	1.375	300	300	0.750	2.125	-	-	-	-
1.0	105	165	165	0.562	1.375	300	300	0.750	2.125	-	-	-	-
1.5	155	155	155	0.562	1.625	265	265	1.000	1.875	-	-	-	-
2.0	205	150	150	0.670	1.625	215	215	1.000	2.625	-	-	-	-
2.2	225	150	150	0.670	1.625	215	215	1.000	2.625	-	-	-	-
2.5	255	145	145	0.670	1.875	-	-	-	-	-	-	-	-
3.0	305	140	140	0.750	1.875	-	-	-	-	-	-	-	-
3.3	335	140	140	0.750	1.875	-	-	-	-	-	-	-	-
4.0	405	135	135	0.750	2.125	-	-	-	-	-	-	-	-
4.7	475	130	130	0.750	2.375	-	-	-	-	-	-	-	-
5.0	505	130	130	0.750	2.375	-	-	-	-	-	-	-	-
6.8	685	110	110	1.000	1.875	-	-	-	-	-	-	-	-
8.0	805	100	100	1.000	2.125	-	-	-	-	-	-	-	-
9.0	905	090	090	1.000	2.375	-	-	-	-	-	-	-	-
10.0	106	080	080	1.000	2.625	-	-	-	-	-	-	-	-

Additional capacitance values, voltages, and tolerances are available upon request.

* The dimensions tabulated above are for styles 02, 04, and 13. Subtract 0.062" from the length for styles 01, 03, and 12.

METAL-CASE HERMETICALLY-SEALED METALIZED POLYPHENYLENE SULFIDE FILM CAPACITORS



FEATURES

- High stability, polycarbonate replacement
- Small size
- Low power dissipation
- Low dielectric absorption
- Wire leads or tab terminals

MAJOR APPLICATIONS:

Storage, filtering, timing, integrating, and applications where severe environments require hermetically sealed cases.

PHYSICAL CHARACTERISTICS

CONSTRUCTION:

Non-inductive wound metalized polyphenylene sulfide.

CASE:

Hermetically sealed metal enclosure. Styles and dimensions are in Guide to Ordering section in the front of the catalog.

LEAD MATERIAL:

Solder coated solid wire.

LEAD WIRE SIZES:

Case Dia.	Lead AWG
0.175 and 0.195	No. 24
0.235	No. 22
0.312	No. 20
0.400 and over	No. 18

LEAD PULL: 5 lbs (2.3 kg) for one minute. No physical damage.

LEAD BEND: After three complete consecutive bends. No damage.

MARKING:

Dearborn trademark, type or catalog number, capacitance, tolerance and voltage.

ELECTRICAL SPECIFICATIONS

CAPACITANCE RANGE:

0.01 μ F to 10.0 μ F

AC VOLTAGE RANGE:

126 to 250 VRMS

CAPACITANCE TOLERANCE:

\pm 20%, \pm 10%, \pm 5%

OPERATING TEMPERATURE:

- -55°C to +125°C
- AC operation limited to +105°C

VOLTAGE DERATING:

- At +105°C, 70% of the DC rated voltage
- At +125°C, 50% of the DC rated voltage

DISSIPATION FACTOR:

0.15% maximum when measured @ 1 kHz @ 25°C

VOLTAGE TEST:

200% of rated voltage for 2 minutes

INSULATION RESISTANCE:

Measured at rated VDC after a 2 minute charge.

- At +25°C, 100,000 Megaohm-Microfarads, need not exceed 200,000 Megaohms
- At +85°C, 10,000 Megaohm-Microfarads, need not exceed 50,000 Megaohms
- At +125°C, 1,000 Megaohm-Microfarads, need not exceed 2,000 Megaohms

MAXIMUM PULSE RISE TIME

Capacitor Length (inch)	Rise Time dv / dt (V / μ s)			
	200 V	300 V	400 V	600 V
0.750	40	80	-	-
0.875	24	45	70	100
1.125	16	30	41	75
1.375	13	23	28	50
1.625	10	-	21	38
1.875	7.6	13	18	27
2.125	6.4	-	15.5	-
2.375	5.5	9.6	-	19
2.625	4.8	8.5	10	-

METAL-CASE HERMETICALLY-SEALED METALIZED POLYPHENYLENE SULFIDE FILM CAPACITORS

TYPE 860P

STANDARD RATINGS

Capacitance		Voltage Code 200 200 VDC / 126 VAC*		Voltage Code 300 300 VDC / 180 VAC*		Voltage Code 400 400 VDC / 220 VAC*		Voltage Code 600 600 VDC / 250 VAC*	
μF	Code	D	L	D	L	D	L	D	L
0.010	103	0.174	0.750	0.235	0.750	0.312	0.875	0.312	0.875
0.015	153	0.193	0.750	0.312	0.875	0.312	0.875	0.400	1.125
0.022	223	0.235	0.750	0.312	0.875	0.312	0.875	0.400	1.125
0.033	333	0.235	0.750	0.312	0.875	0.312	1.125	0.400	1.125
0.047	473	0.312	0.875	0.312	0.875	0.312	1.125	0.400	1.375
0.068	683	0.312	0.875	0.312	1.125	0.400	1.125	0.562	1.125
0.10	104	0.312	0.875	0.400	1.125	0.400	1.375	0.562	1.375
0.15	154	0.312	1.125	0.400	1.375	0.500	1.125	0.562	1.625
0.22	224	0.400	0.875	0.500	1.125	0.562	1.375	0.670	1.625
0.33	334	0.400	1.125	0.562	1.125	0.562	1.625	0.750	1.875
0.47	474	0.400	1.375	0.562	1.375	0.670	1.625	0.750	2.375
0.68	684	0.562	1.125	0.562	1.875	0.670	1.875	1.000	1.875
1.00	105	0.562	1.375	0.670	1.875	0.750	2.125	1.000	2.375
2.00	205	0.670	1.625	0.750	2.375	1.000	2.125	-	-
2.50	255	0.670	1.875	0.750	2.625	1.000	2.625	-	-
3.00	305	0.750	1.875	1.000	1.875	-	-	-	-
4.00	405	0.750	2.125	1.000	2.375	-	-	-	-
5.00	505	0.750	2.375	-	-	-	-	-	-
6.00	605	1.000	1.875	-	-	-	-	-	-
7.00	705	1.000	1.875	-	-	-	-	-	-
10.00	106	1.000	2.625	-	-	-	-	-	-

Additional capacitance values, voltages, and tolerances are available upon request.

* AC voltage rating is at 400Hz. 1.4 x VRMS + VDC should not exceed the rated VDC.

* Graphs of AC voltage vs. frequency follow.

* The dimensions tabulated above are for styles 02, 04, and 13. Subtract 0.062" from the length for styles 01, 03, and 12.

METAL-CASE HERMETICALLY-SEALED METALIZED POLYPHENYLENE SULFIDE FILM CAPACITORS

VOLTAGE VS. FREQUENCY TYPE 860P
200 VDC / 126 VAC

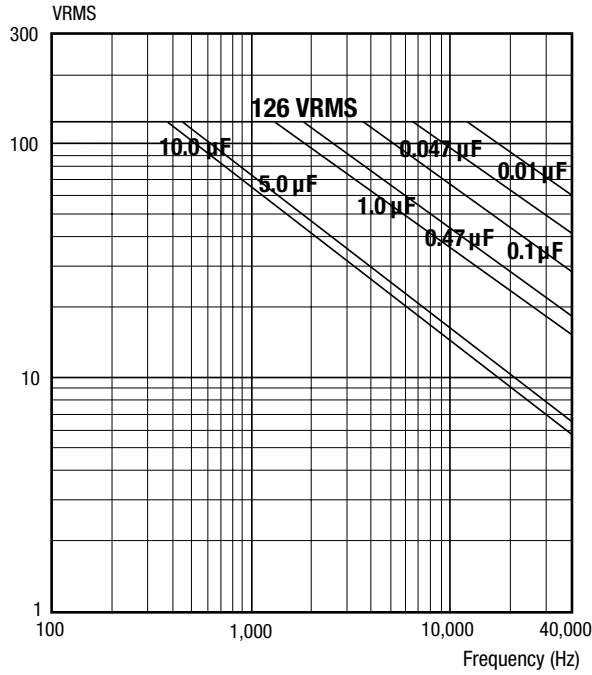

VOLTAGE VS. FREQUENCY TYPE 860P
300 VDC / 180 VAC

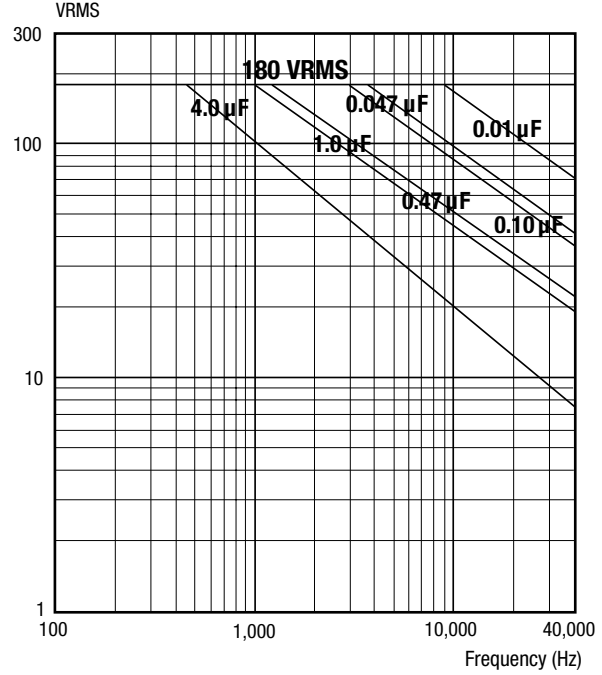

VOLTAGE VS. FREQUENCY TYPE 860P
400 VDC / 220 VAC

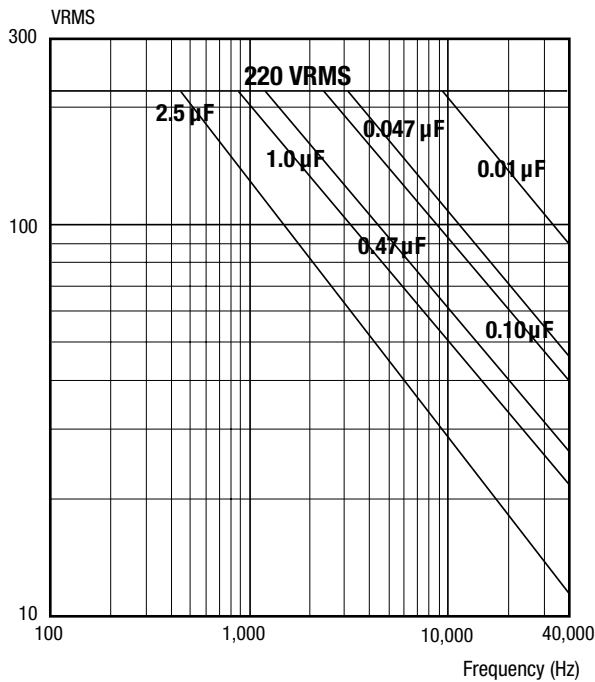

VOLTAGE VS. FREQUENCY TYPE 860P
600 VDC / 250 VAC

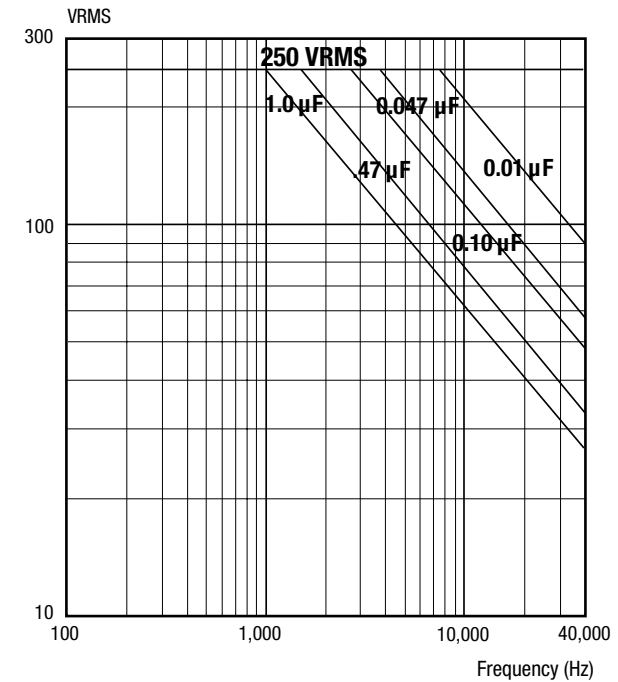



FEATURES

- Moderate cost
- Small size
- Extensive standard ratings
- Wire leads or tab terminals
- Approved to MIL-PRF-39022 / 01 / 02 / 08

MAJOR APPLICATIONS:

Bypass, coupling, and filtering.

PHYSICAL CHARACTERISTICS

CONSTRUCTION:

Non-inductive wound metalized paper / polyester.

CASE:

Hermetically sealed metal enclosure. Styles and dimensions are in Guide to Ordering section in the front of the catalog.

LEAD MATERIAL:

Solder coated solid wire.

LEAD WIRE SIZES:

Case Dia.	Lead AWG
0.175 and 0.195	No. 24
0.235 and 0.312	No. 22
0.400 and over	No. 20

LEAD PULL:

5 lbs (2.3 kg) for one minute. No physical damage.

LEAD BEND:

After three complete consecutive bends. No damage.

MARKING:

Dearborn trademark, type or catalog number, capacitance, tolerance and voltage.

ELECTRICAL SPECIFICATIONS

CAPACITANCE RANGE:

0.001 μ F to 12 μ F

DC VOLTAGE RATING:

200 VDC to 1,000 VDC

AC VOLTAGE RATING:

See graphs of AC voltage vs frequency and AC voltage vs. temperature

CAPACITANCE TOLERANCE:

\pm 20%, \pm 10%, \pm 5%

OPERATING TEMPERATURE:

-55°C TO +125°C

VOLTAGE DERATING:

At +125°C, 50% of +85°C rating

DISSIPATION FACTOR:

1.0% maximum

DC VOLTAGE TEST:

200% of rated voltage for 1 minute

INSULATION RESISTANCE:

Measurements made after a 2 minute charge at rated voltage or 500 VDC, whichever is less.

- At +25°C, 2,000 Megaohm-Microfarads, need not exceed 12,000 Megaohms
- At +125°C, 40 Megaohm-Microfarads, need not exceed 600 Megaohms

METAL-CASE METALIZED PAPER / POLYESTER FILM CAPACITORS

STANDARD RATINGS

Capacitance		Voltage Code 200 200 VDC		Voltage Code 400 400 VDC		Voltage Code 600 600 VDC		Voltage Code 1K0 1,000 VDC	
µF	Code	D	L	D	L	D	L	D	L
0.0010	102	0.174	0.750	0.235	0.750	0.235	0.750	0.400	0.750
0.0015	153	0.174	0.750	0.235	0.750	0.235	0.750	0.400	0.750
0.0022	222	0.174	0.750	0.235	0.750	0.235	0.750	0.400	0.750
0.0033	332	0.174	0.750	0.235	0.750	0.235	0.750	0.400	0.750
0.0047	472	0.174	0.750	0.312	0.875	0.312	0.875	0.400	0.750
0.0068	682	0.174	0.750	0.312	0.875	0.312	0.875	0.400	0.750
0.010	103	0.174	0.750	0.312	0.875	0.312	0.875	0.400	0.875
0.015	153	0.193	0.750	0.312	0.875	0.312	0.875	0.400	0.875
0.022	223	0.235	0.750	0.312	0.875	0.312	1.125	0.400	1.125
0.033	333	0.235	0.750	0.312	1.125	0.312	1.125	0.400	1.125
0.047	473	0.312	0.875	0.400	1.125	0.400	1.125	0.500	1.125
0.068	683	0.312	0.875	0.400	1.125	0.400	1.125	0.500	1.125
0.10	104	0.312	0.875	0.500	1.125	0.500	1.125	0.562	1.125
0.15	154	0.312	1.125	0.500	1.125	0.562	1.125	0.562	1.125
0.22	224	0.400	0.875	0.562	1.375	0.562	1.375	0.670	1.625
0.33	334	0.400	1.125	0.562	1.625	0.562	1.625	0.670	1.875
0.47	474	0.500	1.125	0.670	1.625	0.670	1.625	0.750	1.875
0.68	684	0.500	1.125	0.670	1.875	0.670	1.875	1.000	1.875
1.00	105	0.562	1.125	0.750	1.875	1.000	1.875	1.000	2.125
1.50	155	0.562	1.625	1.000	1.875	1.000	1.875	1.000	2.625
2.00	205	0.670	1.625	1.000	1.875	1.000	2.125	-	-
3.00	305	0.670	1.875	1.000	2.625	-	-	-	-
4.00	405	0.750	1.875	-	-	-	-	-	-
5.00	505	1.000	1.875	-	-	-	-	-	-
6.00	605	1.000	1.875	-	-	-	-	-	-
8.00	805	1.000	1.875	-	-	-	-	-	-
10.00	106	1.000	2.375	-	-	-	-	-	-
12.00	126	1.000	2.625	-	-	-	-	-	-

Additional capacitance values, voltages and tolerances available upon request.

ELECTRICAL CHARACTERISTICS VS. TEMPERATURE

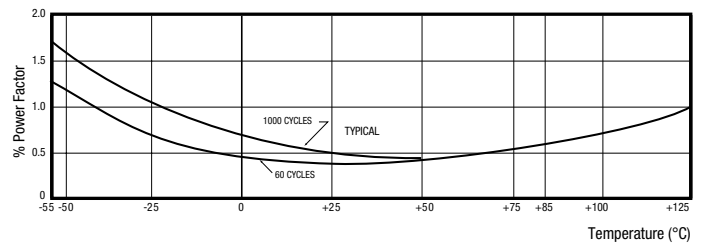
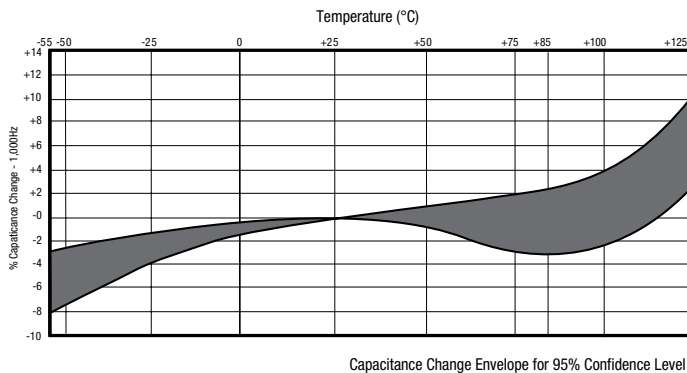

METAL-CASE METALIZED PAPER / POLYESTER FILM CAPACITORS

TYPE 118P

AC VOLTAGE RATINGS VS. TEMPERATURE

AC VOLTAGE RATINGS AT 400HZ AND 85°C AMBIENT

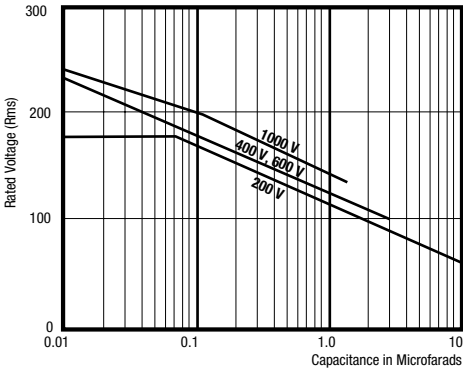

AC VOLTAGE RATINGS VS. FREQUENCY

AC RATINGS AT 1,000HZ

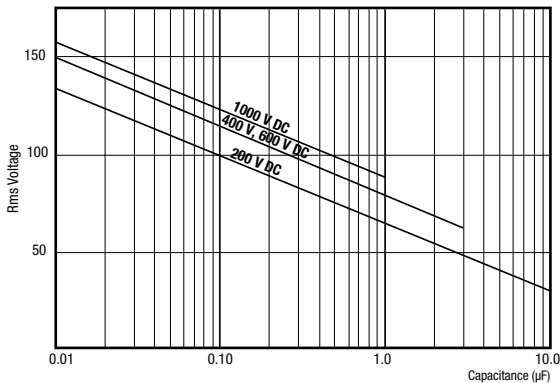

AC VOLTAGE RATINGS AT 400HZ AND 105°C AMBIENT

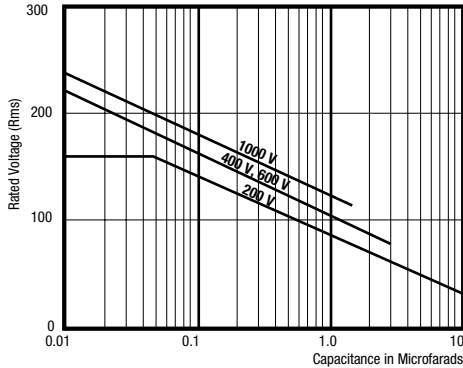

AC RATINGS AT 2,000HZ

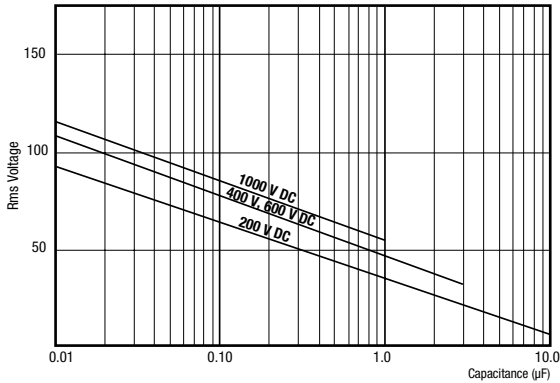

AC VOLTAGE RATINGS AT 400HZ AND 125°C AMBIENT

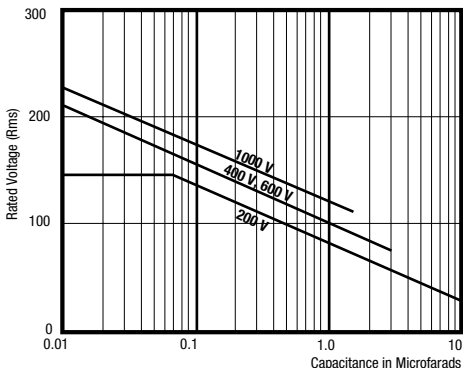

AC RATINGS AT 2,500HZ

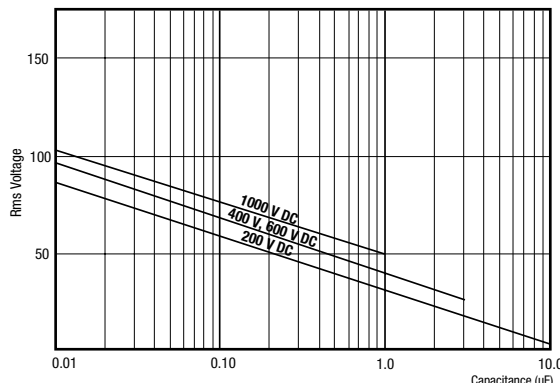

METAL-CASE SUBMINIATURE 10 AMPERE THRU-PASS PAPER CAPACITORS



FEATURES

- Bulkhead mounting
- Excellent RFI specs
- Hermetically encased
- Low inductance connection
- Low insertion loss
- Approved to MIL-PRF-11693 / 07
- 10 Amp current ratings

MAJOR APPLICATIONS:

Used to suppress RF interference in the following equipment, rotating machinery, ignition systems, electromechanical devices, and electronic device.

PHYSICAL CHARACTERISTICS

CONSTRUCTION:

Non-inductive wound paper / foil, wound around a feed-thru bus. The case is the common ground of the three terminal network.

CASE:

Hermetically sealed metal enclosure; the case and terminal styles are shown above.

LEAD PULL:

5 lbs (2.3 kg) for one minute. No physical damage.

LEAD / BEND:

After three complete consecutive bends. No damage.

MARKING:

Dearborn trademark, type or catalog number, capacitance, tolerance and voltage.

ELECTRICAL SPECIFICATIONS

CAPACITANCE RANGE: 0.001 μ F to 1.0 μ F

DC VOLTAGE RANGE: 200 VDC to 600 VDC

CAPACITANCE TOLERANCE: \pm 20%, \pm 10%

OPERATING TEMPERATURE: -55°C to +125°C

VOLTAGE DERATING: At +125°C, 50% of the 85°C rating

DISSIPATION FACTOR: 1.0% maximum

VOLTAGE TEST: 200% of rated voltage for 2 minutes

INSULATION RESISTANCE:

Measure at rated voltage, not to exceed 500 VDC, after a 2 minute charge.

- At +25°C, 20,000 Megohm-Microfarads, need not exceed 30,000 Megaohms
- At +85°C, 200 Megohm-Microfarads, need not exceed 300 Megaohms

DC RESISTANCE: 0.01 ohms maximum

INSERTION LOSS: See table on next page

CIRCUIT DIAGRAM



DIMENSIONS (in inches)

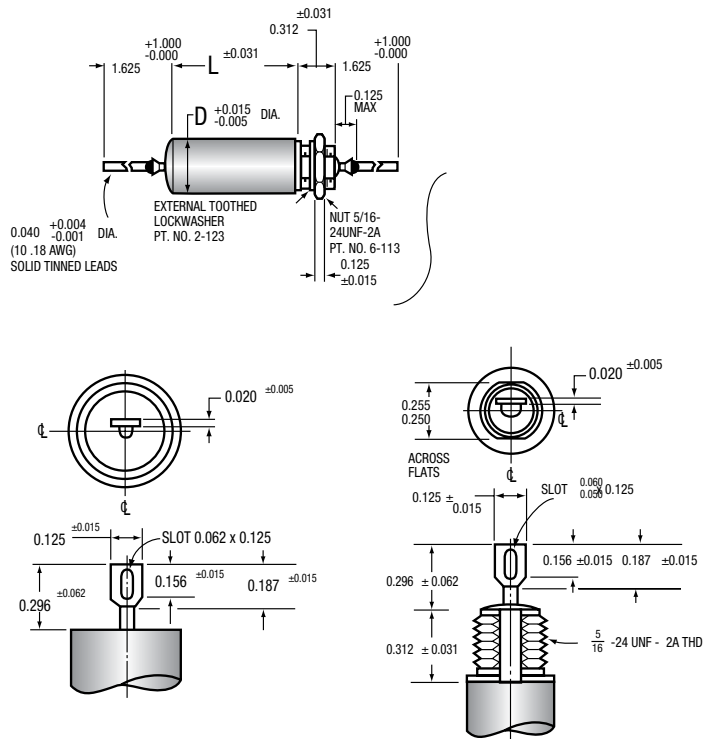

METAL-CASE SUBMINIATURE 10 AMPERE THRU-PASS PAPER CAPACITORS

TYPE 103P

STANDARD RATINGS

μF	Catalog No.*		Inches		Millimeters	
	Tab. Term	Wire Lead	D	L	D	L
200 VDC						
0.047	103P473X0200T	103P473X0200S	0.400	0.875	10.16	22.23
0.10	103P104X0200T	103P104X0200S	0.400	1.125	10.16	28.58
0.22	103P224X0200T	103P224X0200S	0.562	1.125	14.27	28.58
0.47	103P474X0200T	103P474X0200S	0.562	1.875	14.27	47.53
1.00	103P105X0200T	103P105X0200S	0.750	2.125	19.05	53.96
300 VDC						
0.047	103P473X0300T	103P473X0300S	0.400	1.125	10.16	28.58
0.10	103P104X0300T	103P104X0300S	0.400	1.375	10.16	34.83
0.22	103P224X0300T	103P224X0300S	0.562	1.375	14.27	34.83
0.47	103P474X0300T	103P474X0300S	0.670	1.875	17.02	47.83
400 VDC						
0.047	103P473X0400T	103P473X0400S	0.400	1.375	10.16	34.93
0.10	103P104X0400T	103P104X0400S	0.562	1.125	14.27	28.58
0.22	103P224X0400T	103P224X0400S	0.562	1.875	14.27	47.83
0.47	103P474X0400T	103P474X0400S	0.750	2.125	19.05	53.98
600 VDC						
0.0010	103P102X0600T	103P102X0600S	0.400	0.750	10.16	19.05
0.0047	103P472X0600T	103P472X0600S	0.400	0.750	10.16	19.05
0.010	103P103X0600T	103P103X0600S	0.400	0.750	10.16	19.05
0.047	103P473X0600T	103P473X0600S	0.400	1.375	10.16	34.93
0.10	103P104X0600T	103P104X0600S	0.562	1.375	14.27	34.93
0.22	103P224X0600T	103P224X0600S	0.670	1.875	17.02	47.83
0.47	103P474X0600T	103P474X0600S	0.750	2.375	19.05	60.32

*The catalog numbers given are for capacitance tolerance of ± 20%. To specify ± 10% tolerance, change X0 to X9. Mounting hardware furnished unassembled.

ELECTRICAL CHARACTERISTICS VS. TEMPERATURE

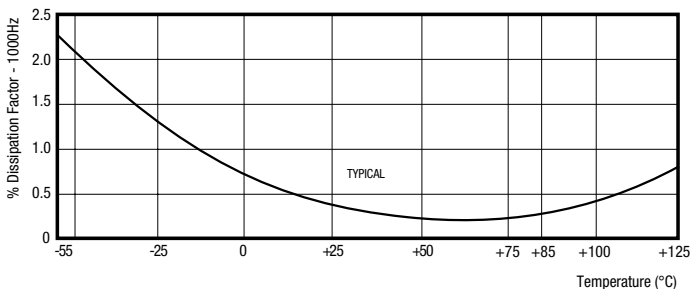
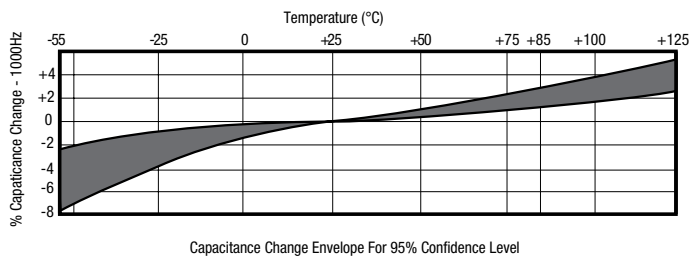

INSERTION LOSS CHARACTERISTICS FOR IDEAL CAPACITORS

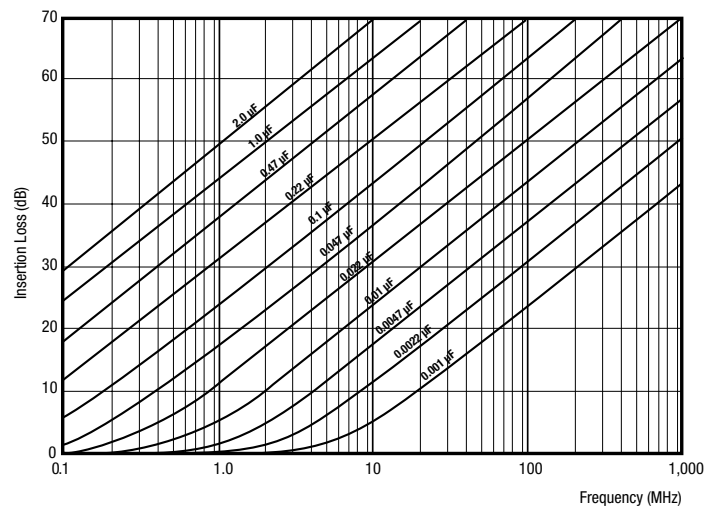

These capacitors are designed to meet all the electrical, mechanical, and environmental requirements of Military Specification MIL-PRF-11693. The insertion loss of such capacitors is defined by this military specification as follows: "...the insertion loss shall be not more than 6 decibels (dB) permissible dips below the value shown on the graph above for an ideal capacitor of the same nominal capacitance value, when tested at frequencies from 0.15 megahertz (MHz) up to that frequency at which the insertion loss of the capacitor under test becomes 60 dB; at all higher frequencies, up to 1,000MHz, the insertion loss shall not fall below 60 dB. Deviations in the nature of dips in the curve will be permitted; such dips indicate a drop in insertion loss below that of an ideal capacitor followed by a rise in insertion loss, as frequency is increased, faster than the rise that is characteristic of an ideal capacitor. Such dips are characteristic of all extended foil capacitors."

PAPER / POLYESTER DIELECTRIC EXTENDED FOIL ELECTRODES



FEATURES

- Moderate cost
- Small size
- High peak current ratings
- High corona starting voltage
- Approved to MIL-PRF-19978

MAJOR APPLICATIONS:

High voltage, high current, high pulse operations, protection circuits, and snubber applications.

PHYSICAL CHARACTERISTICS

CONSTRUCTION:

Non-inductive wound paper / polyester dielectric with extended foil electrodes. Impregnated with vitamin Q.

CASE:

Hermetically sealed metal enclosure. Styles and dimensions are in Guide to Ordering section in the front of the catalog.

LEAD MATERIAL:

Solder coated solid wire.

LEAD WIRE SIZES:

Case Dia.	Lead AWG
0.235 and 0.312	No. 22
0.400 and over	No. 20

LEAD PULL:

5 lbs (2.3 kg) for one minute. No physical damage.

LEAD BEND:

After three complete consecutive bends. No damage.

MARKING:

Dearborn trademark, type or catalog number, capacitance, tolerance, and voltage.

ELECTRICAL SPECIFICATIONS

CAPACITANCE RANGE:

0.001 μ F to 1.0 μ F

VOLTAGE RATING:

200 VDC to 1,000 VDC

CAPACITANCE TOLERANCE:

\pm 20%, \pm 10%, \pm 5%

OPERATING TEMPERATURE:

-65°C to +125°C

VOLTAGE DERATING:

At +125°C, 50% of the 85°C rating

DISSIPATION FACTOR:

1.0% maximum

DC VOLTAGE TEST:

200% of rated voltage for 2 minutes

INSULATION RESISTANCE:

Measure at rated VDC or 500 V, whichever is less, after a 2 minute charge.

- At +25°C, 20,000 Megaohm-Microfarads, need not exceed 30,000 Megaohms
- At +125°C, 20 Megaohm-Microfarads, need not exceed 250 Megaohms

MAXIMUM PULSE RISE TIME

Capacitor Length (inch)	Rise Time dv / dt (V / μ s)			
	200 VDC	400 VDC	600 VDC	1,000 VDC
0.750	1600	1600	4500	-
0.875	1000	1400	1500	2500
1.125	500	800	1000	1500
1.375	350	500	800	1000
1.625	250	350	500	800
1.875	-	-	-	550
2.125	200	300	400	500
2.375	-	-	300	450

PAPER / POLYESTER DIELECTRIC EXTENDED FOIL ELECTRODES

TYPE 131P

STANDARD RATINGS

Capacitance		Voltage Code 200 200 VDC		Voltage Code 400 400 VDC		Voltage Code 600 600 VDC		Voltage Code 1K0 1,000 VDC	
µF	Code	D	L	D	L	D	L	D	L
0.0010	102	-	-	-	-	0.235	0.750	0.400	0.875
0.0015	152	-	-	-	-	0.235	0.750	0.400	0.875
0.0022	222	-	-	-	-	0.235	0.750	0.400	0.875
0.0033	332	-	-	0.235	0.750	0.312	0.875	0.400	0.875
0.0047	472	0.235	0.750	0.235	0.750	0.312	0.875	0.400	0.875
0.0068	682	0.235	0.750	0.235	0.750	0.312	0.875	0.400	0.875
0.010	103	0.235	0.750	0.235	0.750	0.312	0.875	0.400	0.875
0.015	153	0.312	0.875	0.312	0.875	0.400	0.875	0.400	1.125
0.022	223	0.312	0.875	0.400	0.875	0.400	0.875	0.400	1.375
0.033	333	0.312	0.875	0.400	0.875	0.400	1.125	0.562	1.125
0.047	473	0.400	0.875	0.400	1.125	0.400	1.375	0.562	1.375
0.068	683	0.400	0.875	0.400	1.375	0.562	1.125	0.562	1.625
0.10	104	0.400	1.125	0.562	1.125	0.562	1.375	0.670	1.625
0.15	154	0.400	1.375	0.562	1.375	0.562	1.625	0.670	1.875
0.22	224	0.562	1.125	0.562	1.625	0.670	1.625	0.750	2.125
0.33	334	0.562	1.375	0.670	1.625	0.750	2.125	1.000	2.125
0.47	474	0.562	1.625	0.750	2.125	0.750	2.375	1.000	2.375
0.68	684	0.670	1.625	-	-	-	-	-	-
1.00	105	0.750	2.125	-	-	-	-	-	-

Additional capacitance values, voltages, and tolerances are available upon request.

* The dimensions shown are for style 02. The dimensions for other styles are included in the general section in the front of the catalog.

PAPER / POLYESTER DIELECTRIC EXTENDED FOIL ELECTRODES



FEATURES

- Moderate cost
- Small size
- High peak current ratings
- High corona starting voltage
- Approved to MIL-PRF-19978

MAJOR APPLICATIONS:

High voltage, high current, high pulse operations, protection circuits, and snubber applications.

PHYSICAL CHARACTERISTICS

CONSTRUCTION:

Non-inductive wound paper / polyester dielectric with extended foil electrodes. Impregnated with vitamin Q.

CASE:

Hermetically sealed metal enclosure. Styles and dimensions are in Guide to Ordering section in the front of the catalog.

LEAD MATERIAL:

Solder coated solid wire.

LEAD WIRE SIZES:

Case Dia.	Lead AWG
< 0.235	No. 24
< 0.235 and 0.312	No. 22
0.400 and over	No. 20

LEAD PULL:

5 lbs (2.3 kg) for one minute. No physical damage.

LEAD BEND:

After three complete consecutive bends. No damage.

MARKING:

Dearborn trademark, type or catalog number, capacitance, tolerance, and voltage.

ELECTRICAL SPECIFICATIONS

CAPACITANCE RANGE:

0.001 μ F to 1.0 μ F

VOLTAGE RATING:

100 VDC to 1,000 VDC

CAPACITANCE TOLERANCE:

\pm 20%, \pm 10%, \pm 5%

OPERATING TEMPERATURE:

-65°C to +125°C

VOLTAGE DERATING:

At +125°C, 50% of the 85°C rating

DISSIPATION FACTOR:

1.0% maximum

DC VOLTAGE TEST:

200% of rated voltage for 2 minutes

INSULATION RESISTANCE:

Measure at rated VDC or 500 V, whichever is less, after a 2 minute charge.

- At +25°C, 20,000 Megaohm-Microfarads, need not exceed 30,000 Megaohms
- At +125°C, 20 Megaohm-Microfarads, need not exceed 250 Megaohms

MAXIMUM PULSE RISE TIME

Capacitor Length (inch)	Rise Time dv / dt (V / μ s)					
	100 VDC	200 VDC	300 VDC	400 VDC	600 VDC	1,000 VDC
0.687 / 0.750	800	1600	2000	3000	4500	-
0.812 / 0.875	700	1000	1000	1000	1500	2500
1.062 / 1.125	400	500	650	800	1000	1500
1.312 / 1.375	300	350	425	500	800	1000
1.562 / 1.625	200	250	300	350	500	800
1.812 / 1.875	-	-	-	-	-	550
2.062 / 2.125	-	200	250	300	400	500
2.312 / 2.375	-	-	-	-	300	450

PAPER / POLYESTER DIELECTRIC EXTENDED FOIL ELECTRODES

TYPE 132P

STANDARD RATINGS

Capacitance		Voltage Code 100 100 VDC		Voltage Code 200 200 VDC		Voltage Code 300 300 VDC		Voltage Code 400 400 VDC		Voltage Code 600 600 VDC		Voltage Code 1000 1,000 VDC	
μF	Code	D	L	D	L	D	L	D	L	D	L	D	L
0.0010	102	0.175	0.687	0.235	0.687	0.235	0.687	0.235	0.687	0.235	0.687	0.400	0.812
0.0015	152	0.175	0.687	0.235	0.687	0.235	0.687	0.235	0.687	0.235	0.687	0.400	0.812
0.0022	222	0.175	0.687	0.235	0.687	0.235	0.687	0.235	0.687	0.235	0.687	0.400	0.812
0.0033	332	0.175	0.687	0.235	0.687	0.235	0.687	0.235	0.687	0.312	0.812	0.400	0.812
0.0047	472	0.175	0.687	0.235	0.687	0.235	0.687	0.312	0.812	0.312	0.812	0.400	0.812
0.0068	682	0.195	0.687	0.235	0.687	0.312	0.812	0.195	0.812	0.312	0.812	0.400	0.812
0.010	103	0.235	0.687	0.312	0.812	0.312	0.812	0.312	0.812	0.312	0.812	0.400	0.812
0.015	153	0.235	0.687	0.312	0.812	0.312	0.812	0.312	0.812	0.400	0.812	0.400	1.062
0.022	223	0.312	0.812	0.312	0.812	0.312	0.812	0.400	0.812	0.400	0.812	0.400	1.312
0.033	333	0.312	0.812	0.312	0.812	0.400	0.812	0.400	0.812	0.400	1.062	0.562	1.062
0.047	473	0.312	0.812	0.400	0.812	0.400	0.812	0.400	1.062	0.400	1.312	0.562	1.312
0.068	683	0.400	0.812	0.400	0.812	0.400	1.062	0.400	1.312	0.562	1.062	0.562	1.562
0.10	104	0.400	0.812	0.400	1.062	0.400	1.312	0.562	1.062	0.562	1.312	0.670	1.562
0.15	154	0.400	1.062	0.400	1.312	0.562	1.062	0.562	1.312	0.562	1.562	0.670	1.812
0.22	224	0.400	1.062	0.562	1.062	0.562	1.312	0.562	1.562	0.670	1.562	0.750	2.062
0.33	334	0.562	1.062	0.562	1.312	0.562	1.562	0.670	1.562	0.750	2.062	1.000	2.062
0.47	474	0.562	1.312	0.562	1.562	0.670	1.562	0.750	2.062	0.750	2.312	1.000	2.312
0.68	684	0.562	1.562	0.670	1.562	0.750	2.062	-	-	-	-	-	-
1.00	105	0.670	1.562	0.750	2.062	-	-	-	-	-	-	-	-

Additional capacitance values, voltages, and tolerances are available upon request.

* The dimensions Tabulated above are for styles 01, 03, and 12. Add 0.062" to the length for styles 02, 04, and 13.

BATHTUB STYLE METAL CASE PAPER / POLYESTER FOIL CAPACITORS



FEATURES

- Capacitance values to 10 μF
- Drawn metal "bathtub" cases
- Top, side, or bottom terminals
- Approved to MIL-C-25

MAJOR APPLICATIONS:

Bypass, coupling, filtering.

PHYSICAL CHARACTERISTICS

CONSTRUCTION:

Non-inductive wound paper / polyester film with extended foil electrodes.

CASE:

Hermetically sealed metal enclosure.

TERMINALS: SYMBOL B

Glass to metal solder-seal with non removable solder lug.

MARKING:

Dearborn trademark, type number, capacitance, tolerance, voltage, and date code.

ELECTRICAL SPECIFICATIONS

CAPACITANCE RANGE:

0.05 μF to 10.0 μF

DC VOLTAGE RATING:

100 VDC to 1,000 VDC

CAPACITANCE TOLERANCE:

- K, $\pm 10\%$
- V, $+20 -10\%$

OPERATING TEMPERATURE:

- Characteristics E and F -55°C to $+85^{\circ}\text{C}$
- Characteristic K -55°C to $+125^{\circ}\text{C}$

VOLTAGE DERATING:

- Characteristics E and F at $+85^{\circ}\text{C}$, 65% of rated voltage
- Characteristic K at $+125^{\circ}\text{C}$, 70% of rated voltage

DISSIPATION FACTOR:

1.0% maximum

DIMENSIONS (in inches)

TYPE CP53

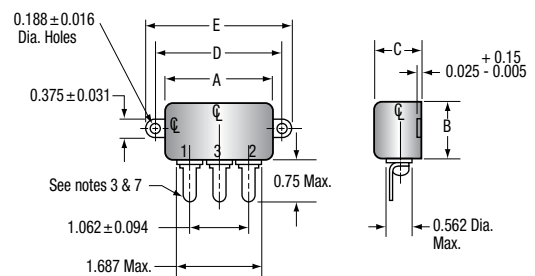

TYPE CP54

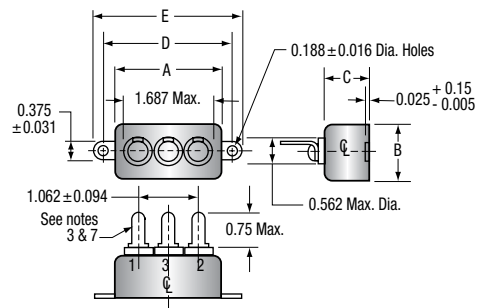

TYPE CP55

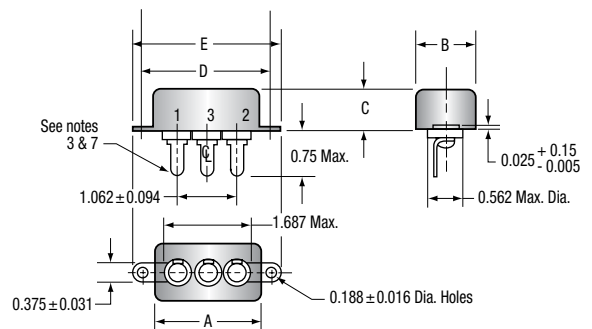

Note:

1. See following tables for additional dimensions.
2. All dimensions in inches.
3. Terminals need not be identified by numbers as shown. Shape of terminals and terminal lugs (drilled, punched, forked, or slotted) optional.
4. Mounting holes may be elongated.
5. For circuit 1, use terminals 1 and 2. For circuit 2, use terminal 1. For circuit 4, use terminal 1 for common connection and identify common terminal by the letter C on case adjacent to terminal. For circuit 6, use terminals 1 and 2.
6. Capacitors differ only in location of terminals. Style CP53, having the terminals on one side, contains certain values of capacitance in a smaller case than is possible with styles CP54 and CP55, the terminals of which are on top and bottom faces respectively.
7. Terminal lugs shall be oriented as shown with respect to side of case bearing terminal identification numbers.

BATHTUB STYLE METAL CASE PAPER / POLYESTER FOIL CAPACITORS

TYPE CP53/54/55

DIELECTRIC WITHSTANDING VOLTAGE TEST

Circuit symbol	Circuit diagram	Test	Test connections	Test Voltage (Percent of Rated DC Voltage)	Time test applied (Minutes)
1		Terminal to terminal	1 to 2	200 ^{1/}	1 ^{2/}
		Terminal to case	1 and 2 to case	400 ^{5/}	1 ^{3/ 4/}
				200 + 1,000 ^{6/} V	1 ^{3/ 4/}
2		Terminal to terminal	1 to case	200 ^{1/}	1 ^{2/}
4		Terminal to terminal	1 to 2 and 3 together	200 ^{1/}	1 ^{7/}
		Terminal to case	1, 2, and 3 to case	200 + 1,000 V	1 ^{3/ 4/}
5		Terminal to case	1, 2, and 3 to case	200	1 ^{7/}
		Terminal to terminal	1 and 2 to 3 1 to 2	200	1 ^{7/}
6		Terminal to terminal	1 and 2 to case	200	1 ^{7/}
			1 to 2	200	1 ^{7/}

^{1/} 175 percent of rated dc voltage after temperature-and immersion-cycling and moisture resistance tests.

^{2/} For quality conformance inspection and at the option of the supplier, either 200 percent of rated dc voltage for not less than 15 seconds or 250 percent of rated voltage for not less than 1 second.

^{3/} For quality conformance inspection, the period of test voltage application shall be 1 second.

^{4/} For quality conformance inspection, applications may be made between each terminal individually and the case, at the option of the supplier.

^{5/} For capacitors having dc voltage ratings of 600 V and less.

^{6/} For capacitors having dc voltage ratings greater than 600 V.

^{7/} For quality conformance inspection, the application may be made for 1 second if the capacitor has passed group A inspection.

TERMINAL TO TERMINAL INSULATION RESISTANCE MEASUREMENTS

Capacitance values	Minimum insulation resistance ^{1/}		
	Characteristic E	Characteristic F	Characteristic K
0.33 microfarads and less greater than 0.33 microfarads	At 25°C 6,000 megaohms 2,000 megaohm ^{2/}	At 25°C 4,500 megaohms 1500 megaohm microfarads ^{2/}	At 25°C 18,000 megaohms 6,000 megaohm microfarads ^{2/}
greater than 0.033 microfarads	At 85°C 20 megaohm microfarads ^{2/}	At 85°C 15 megaohm microfarads ^{2/}	-
0.067 microfarads and less Greater than 0.67 microfarads	-	-	At 125°C 150 megaohms 10 megaohm microfarads ^{2/}

^{1/} A potential equal to the DC rated voltage or 500 VDC, whichever is less shall be applied.

^{2/} Product obtained by multiplying the capacitance in microfarads by the insulation resistance in megaohms.

BATHTUB STYLE METAL CASE PAPER / POLYESTER FOIL CAPACITORS

STANDARD RATINGS

Type Designation ^{1/}	De Voltage Rating (see figure 2)	Capacitance μ F	Capacitance Tolerance ^{2/}	Characteristics	Vibration Grade	Case Size		
						Characteristics E	Characteristics F	Characteristics K
CP5-B-B105K1	100	1	K	E, F	1	A2	A1	-
CP5-B-EB205K1	100	2	K	E	1	B1	-	-
CP5-B-B405K1	100	4	K	E, F	1	C2	C1	-
CP5-B-FB805K1	100	8	K	F	1	-	C1	-
CP5-B-FB106K1	100	10	K	F	1	-	C2	-
CP5-B-FC504K1	200	0.5	K	F	1	-	A1	-
CP5-B-EC105K1	200	1	K	E	1	B1	-	-
CP5-B-EC205K1	200	2	K	E	1	C1	-	-
CP5-B-KE503K1	400	0.05	K	K	1	-	-	A1
CP5-B-KE104K1	400	0.10	K	K	1	-	-	A1
CP5-B-KE254K1	400	0.25	K	K	1	-	-	A1
CP5-B-KE504K1	400	0.5	K	K	1	-	-	B1
CP5-B-KE105K1	400	1	K	K	1	-	-	B1
CP5-B-EF254K1	600	0.25	K	E	1	A1	-	-
CP5-B-F504K1	600	0.5	K	E, F	1	A3	A2	-
CP5-B-F105K1	600	1	K	E, F	1	B2	B1	-
CP5-B-EF205K1	600	2	K	E	1	C2 ^{3/}	-	-
CP5-B-EG503K1	1,000	0.05	K	E	1	A1	-	-
CP5-B-EG104K1	1,000	0.1	K	E	1	A1	-	-
CP5-B-G254K1	1,000	0.25	K	E, F	1	A2	A1	-
CP5-B-EG504K1	1,000	0.5	K	E	1	B1	-	-
CP5-B-EG105K1	1,000	1	K	E	1	C2 ^{3/}	-	-
CP5-B-EF503V1	600	0.05-0.05 4/	V	E	1	A1	-	-
CP5-B-EF104V1	600	0.1-0.1	V	E	1	A1	-	-
CP5-B-F254V1	600	0.25-0.25	V	E, F	1	A3	A2	-
CP5-B-F504V1	600	0.5-0.5	V	E, F	1	B2	B1	-
CP5-B-EF105V1	600	1-1	V	E	1	C2 ^{3/}	-	-
CP5-B-EG503V1	1,000	0.05-0.05	V	E	1	A1	-	-
CP5-B-G104V1	1,000	0.1-0.1	V	E, F	1	A2	A1	-
CP5-B-EG254V1	1,000	0.25-0.25	V	E	1	B1	-	-
CP5-B-EG504V1	1,000	0.5-0.5	V	E	1	C2 ^{3/}	-	-
CP5-B5-E504V1	400	0.5-0.5-0.5	V	E, F	1	C2	C1	-
CP5-B5-F104V1	600	0.1-0.1-0.1	V	E, F	1	A2	A1	-
CP5-B5EF254V1	600	0.25-0.25-0.25	V	E	1	B1	-	-
CP5-B5EF504V1	600	0.5-0.5-0.5	V	E	1	C2 ^{3/}	-	-
CP5-B5EG503V1	1,000	0.05-0.05-0.05	V	E	1	A1	-	-
CP5-B5EG104V1	1,000	0.1-0.1-0.1	V	E	1	B1	-	-
CP5-B5EG254V1	1,000	0.25-0.25-0.25	V	E	1	C2 ^{3/}	-	-

^{1/} Complete type designation shall include additional symbols to complete style designation. Indicate circuit (where applicable) and characteristics (where applicable).

^{2/} Capacitance tolerance in percent: K, ± 10 ; V, $+20$, -10 .

^{3/} For styles CP54 and CP55, case size is C3.

^{4/} For multiple-unit capacitors, the watt-second rating is the sum of the watt-second ratings of the component sections.

Case Size	A ± 0.062	B ± 0.062	+0.062 C -0.125	D ± 0.031	E ± 0.062
A1	1.812	1.000	0.750	2.125	2.500
A2	1.812	1.000	0.875	2.125	2.500
A3	1.812	1.000	1.000	2.125	2.500
B1	2.000	1.750	0.875	2.375	2.750
B2	2.000	1.750	1.000	2.375	2.750
C1	2.000	2.000	1.000	2.375	2.750
C2	2.000	2.000	1.125	2.375	2.750
C3	2.000	2.000	1.250	2.375	2.750

Refer to MIL-C-25 / 4 for additional information.

GLASS TUBULAR HIGH-VOLTAGE PAPER / POLYESTER DIFILM® CAPACITORS

TYPE 205P



FEATURES

- Glass case
- 2,000 VDC to 10,000 VDC
- Two temperature ranges
- Long leakage path
- High altitude stability
- Similar parts approved to MIL-PRF-19978 / 02

MAJOR APPLICATIONS:

High voltage applications both at high altitude, and ground level. Power supplies, induction heating equipment, electrostatic precipitators, as well as coupling and bypass applications.

PHYSICAL CHARACTERISTICS

CONSTRUCTION:

Dielectric-paper / polyester, electrode-aluminum foil either extended or laid in tab. Impregnated with vitamin Q.

CASE:

Heavy wall tempered glass. Metal ferrules are bonded to the end of the glass and metal end caps are soldered to the ferrules to make a hermetically sealed assembly.

LEAD / TERMINALS:

Tubes with a diameter of 0.53 inches have 20 AWG leads. Larger tube diameters have 8-32 studs on both ends.

LEAD PULL: 5 lbs (2.3 kg) for one minute. No physical damage.

LEAD BEND: After three complete consecutive bends. No damage.

MARKING: Dearborn trademark, type or catalog number, capacitance, and voltage.

ELECTRICAL SPECIFICATIONS

CAPACITANCE RANGE: 0.001 μ F to 0.5 μ F

VOLTAGE RATING: 2,000 VDC to 10,000 VDC

CAPACITANCE TOLERANCE: \pm 20%, \pm 10%

OPERATING TEMPERATURE: -55°C to +85°C or -55°C to +125°C

DISSIPATION FACTOR: 1.0% maximum

DC VOLTAGE TEST: 175% of rated voltage for 1 minute

INSULATION RESISTANCE:

Measure at 500 VDC after a 2 minute charge.

- At +25°C, 20,000 Megaohm-Microfarads, need not exceed 100,000 Megaohms
- At +85°C, 300 Megaohm-Microfarads, need not exceed 2,000 Megaohms
- At +125°C, 20 Megaohm-Microfarads, need not exceed 250 Megaohms

DIMENSIONS (in inches / mm)

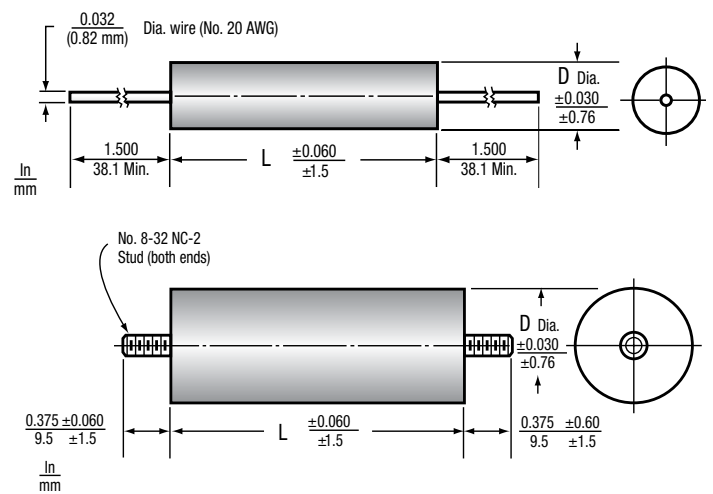

ELECTRICAL CHARACTERISTICS VS. TEMPERATURE

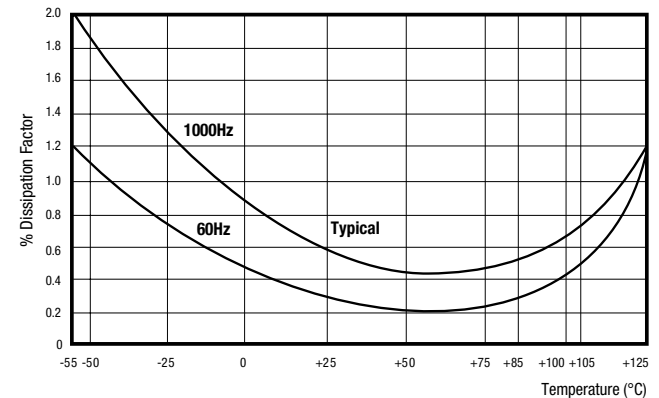
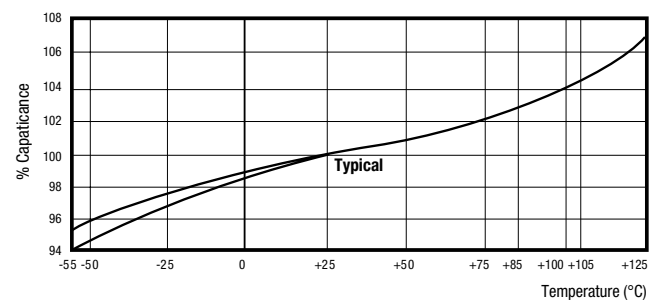

GLASS TUBULAR HIGH-VOLTAGE PAPER / POLYESTER DIFILM® CAPACITORS

STANDARD RATINGS

μF	STANDARD RATINGS FOR +85°C OPERATION			STANDARD RATINGS FOR +125°C OPERATION		
	Catalog Number	Inches		Catalog Number	Inches	
		D	L		D	L
2,000 VDC						
0.001	-	-	-	205P102X92K0SK	0.53	1.19
0.002	-	-	-	205P202X92K0SK	0.53	1.19
0.005	-	-	-	205P502X92K0SK	0.53	1.19
0.01	-	-	-	205P103X92K0SK	0.53	1.19
0.02	205P203X92K0SE	0.53	1.56	205P203X92K0LK	0.63	1.56
0.05	205P503X92K0LE	0.75	1.75	205P503X92K0LK	0.75	2.25
0.10	205P104X92K0LE	0.75	2.25	205P104X92K0LK	1.03	2.25
0.25	205P254X92K0LE	1.03	2.75	205P254X92K0LK	1.34	3.50
0.50	205P504X92K0LE	1.34	2.75	-	-	-
3,000 VDC						
0.001	-	-	-	205P102X93K0SK	0.53	1.19
0.002	-	-	-	205P202X92K0SK	0.53	1.19
0.005	205P502X92K0SE	0.53	1.19	205P502X92K0SK	0.53	1.56
0.01	205P103X92K0SE	0.53	1.56	205P103X93K0LK	0.63	1.56
0.02	205P203X92K0LE	0.63	2.25	205P203X93K0LK	0.75	1.75
0.05	205P503X92K0LE	0.75	2.25	205P503X93K0LK	1.03	2.25
0.10	205P104X92K0LE	1.03	2.25	205P104X93K0LK	1.34	2.75
0.25	205P254X93K0LE	1.34	2.75	-	-	-
4,000 VDC						
0.001	205P102X94K0SE	0.53	1.19	205P102X94K0SK	0.53	1.56
0.002	205P202X94K0SE	0.53	1.19	205P202X94K0SK	0.53	1.56
0.005	205P502X94K0SE	0.53	1.56	205P502X94K0LK	0.63	1.56
0.01	205P103X94K0LE	0.63	1.56	205P103X94K0LK	0.75	1.75
0.02	205P203X94K0LE	0.75	1.75	205P203X94K0LK	0.75	2.25
0.05	205P503X94K0LE	0.87	2.25	205P503X94K0LK	1.34	2.75
0.10	205P104X94K0LE	1.03	2.75	205P104X94K0LK	1.34	2.75
0.25	205P254X94K0LE	1.34	3.50	-	-	-
5,000 VDC						
0.001	-	-	-	205P102X95K0SK	0.53	1.56
0.002	-	-	-	205P202X95K0SK	0.53	1.56
0.005	205P502X95K0SE	0.53	1.56	205P502X95K0LK	0.63	1.56
0.01	205P103X95K0LE	0.63	1.56	205P103X95K0LK	0.75	1.75
0.02	205P203X95K0LE	0.75	1.75	205P203X95K0LK	0.87	2.75
0.05	205P503X95K0LE	0.87	2.25	205P503X95K0LK	1.34	2.25
0.10	205P104X95K0LE	1.03	2.75	205P104X95K0LK	1.34	3.50
7,500 VDC						
0.001	205P102X97K5LE	0.63	2.25	205P102X97K5LK	0.63	2.25
0.002	205P202X97K5LE	0.63	2.25	205P202X97K5LK	0.75	1.75
0.005	205P502X97K5LE	0.75	1.75	205P502X97K5LK	0.75	2.25
0.01	205P103X97K5LE	0.75	2.25	205P103X97K5LK	0.87	2.25
0.02	205P203X97K5LE	1.03	2.75	205P203X97K5LK	1.34	2.75
0.03	-	-	-	205P303X97K5LK	1.34	2.75
0.05	205P503X97K5LE	1.34	2.75	205P503X97K5LK	1.34	4.25
0.10	205P104X97K5LE	1.34	3.50	-	-	-
10,000 VDC						
0.0001	-	-	-	205P101X910KLK	0.63	2.25
0.0002	-	-	-	205P201X910KLK	0.63	2.25
0.0005	-	-	-	205P501X910KLK	0.63	2.25
0.001	205P102X910KLE	0.63	2.25	205P102X910KLK	0.75	2.25
0.002	205P202X910KLE	0.63	2.25	205P202X910KLK	0.87	2.25
0.005	205P502X910KLE	0.75	2.25	205P502X910KLK	1.03	2.75
0.01	205P103X910KLE	1.03	2.75	205P103X910KLK	1.34	2.75
0.02	205P203X910KLE	1.34	2.75	205P203X910KLK	1.34	4.25
0.05	205P503X910KLE	1.34	4.25	-	-	-

The catalog numbers given are for capacitance tolerance of ± 10%. To specify ± 20% tolerance, change X9 to X0.

RECTANGULAR METAL CASE PAPER / POLYESTER FOIL CAPACITORS

TYPE CQ72



FEATURES

- Capacitance values to 15 μF
- Drawn rectangular metal cases
- Solder lug or pillar terminals
- Voltage Ratings 400 to 12,500 VDC
- Approved to MIL-PRF-19978

MAJOR APPLICATIONS:

Bypass coupling, filtering in power supply, radar and other high voltage applications.

PHYSICAL CHARACTERISTICS

CONSTRUCTION:

Non-inductive wound paper / polyester film with extended foil electrodes.

CASE: Hermetically sealed metal enclosure. Styles and dimensions are in Guide to Ordering section in the front of the catalog.

TERMINALS:

See table II for the terminal available for each voltage and tables below for terminal description, number and size.

Symbol	Type of Terminal
B	Solder lug (non removable)
D, H	Pillar insulator (for use at altitudes up to 7,500 feet)
E	Pillar insulator (for use at altitudes up to 50,000 feet)

Terminal Number	Terminal Symbols	Terminal Dimensions			
		V Max.	Y Min.	Y Max.	Z
1	B	0.75	-	-	0.812
2	E	1.375	0.190-32	0.216-24	0.812
3	E	1.75	0.190-32	0.216-24	1.000
4	D, E	2.75	0.190-32	0.3125-18	1.438
5	H	4.250	0.375-16	0.500-13	3.000

Shape of terminal B (drilled, punched, forked, or slotted) is optional.

Capacitors having terminal D or E shall be supplied with necessary terminal hardware for each terminal (two nuts, one of these may be a fixed nut on to the insulator, and one lock washer); in addition, capacitors rated at 3,000 VDC or less shall be supplied with a solder lug capable of accommodating a No. 14 AWG wire for each terminal.

MARKING:

Dearborn trademark, part number, capacitance, tolerance, voltage and date code.

ELECTRICAL SPECIFICATIONS

CAPACITANCE RANGE: 0.10 μF to 15.0 μF

DC VOLTAGE RANGE: 400 VDC to 12,500 VDC

CAPACITANCE TOLERANCE: $K \pm 10\%$

OPERATING TEMPERATURE:

- Characteristic E -65°C to +85°C
- Characteristic F -55°C to +85°C
- Characteristic K -55°C to +125°C

VOLTAGE DERATING:

- Characteristic E and F at +85°C 65% of rated voltage
- Characteristic K at 125°C 70% of rated voltage

DISSIPATION FACTOR: 1.0% maximum

INSULATION RESISTANCE: Measured at rated voltage or 500 VDC whichever is less.

DIMENSIONS (in inches)

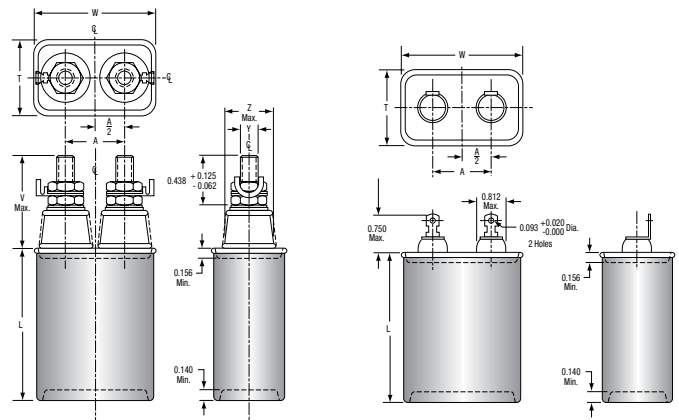

TABLE 1: TERMINAL TO TERMINAL INSULATION RESISTANCE

Capacitance Rating	Minimum Insulation Resistance
Characteristic E	
0 to 0.6 microfarad	At 25°C 25,000 megohms
Greater than 0.6 microfarad	15,000 megohm-microfarads ^{1/}
0 to 0.15 microfarad	At 85°C 2,000 megohms
Greater than 0.15 microfarad	300 megohm-microfarads ^{1/}
Characteristic K	
0 to 0.6 microfarad	At 25°C 25,000 megohms
Greater than 0.15 microfarad	15,000 megohm-microfarads ^{1/}
0 to 0.8 microfarad	At 85°C 250 megohms
Greater than 0.08 microfarad	20 megohm-microfarads ^{1/}
Characteristic F	
0.33 microfarad and less	At 25°C 6,000 megohms
Greater than 0.33 microfarad	2,000 megohm-microfarads ^{1/}
0.33 microfarad and less	At 85°C 600 megohms
Greater than 0.33 microfarad	20 megohm-microfarads ^{1/}
Characteristic G	
0.33 microfarad and less	At 25°C 4,500 megohms
Greater than 0.33 microfarad	1,500 megohm-microfarads ^{1/}
0.033 microfarad and less	At 85°C 450 megohms
Greater than 0.033 microfarad	15 megohm-microfarads ^{1/}

^{1/} Product obtained by multiplying capacitance in microfarads by the insulation resistance in megohms.

RECTANGULAR METAL CASE PAPER / POLYESTER FOIL CAPACITORS

TABLE 2

Part Number	Capacitance μF	Vibration Grade	Case Size Characteristic				Available Terminal Identification No. Terminal			
			E	K	F	G	B	D	E	H
400 DC Voltage Rating (Volt)										
CQ72-1KE254K3	0.25	3	-	A1	-	-	1	-	2	-
CQ72-1-E504K3	0.5	3	A1	A2	-	-	1	-	2	-
CQ72-1-E105K3	1.0	3	A1	A3	-	-	1	-	2	-
CQ72-1-E205K3	2	3	A2	A5	-	-	1	-	2	-
CQ72-1-E405K3	4	3	B2	B6	-	-	1	-	2	-
CQ72-1-E605K3	6	3	B6	C3	-	-	1	-	2	-
CQ72-1-E805K3	8	3	C3	D4	-	-	1	-	2	-
CQ72-1-E106K3	10	3	C4	E4	-	-	1	-	2	-
CQ72-1-E126K3	12	3	D2	E6	-	-	1	-	2	-
CQ72-1-E156K3	15	3	D5	G4	-	-	1	-	2	-
600 DC Voltage Rating (Volt)										
CQ72-1FF254K1	0.25	1	-	-	A1	-	1	-	2	-
CQ72-1-F504K3	0.5	3	A1	A2	-	-	1	-	2	-
CQ72-1-F105K-	1.0	1.3	A2	A3	-	-	1	-	2	-
CQ72-1-F205K-	2	1.3	A2	B4	A4	A3	1	-	2	-
CQ72-1-F405K-	4	1.3	B3	D2	B4	B3	1	-	2	-
CQ72-1-F605K-	6	1.3	B6	E4	C2	B6	1	-	2	-
CQ72-1-F805K-	8	1.3	C2	F1	C3	C2	1	-	2	-
CQ72-1-F106K-	10	1.3	C4	J2	D3	C4	1	-	2	-
CQ72-1-F126K3	12	3	E2	J3	-	-	1	-	2	-
CQ72-1-F156K3	15	3	E5	J6	-	-	1	-	2	-
1,000 DC Voltage Rating (Volt)										
CQ72-1FG104K1	0.1	1	-	-	A1	-	1	-	2	-
CQ72-1-G254K-	0.25	1.3	-	A2	A2	-	1	-	2	-
CQ72-1-G504K-	0.5	1.3	A1	A3	A2	-	1	-	2	-
CQ72-1-G105K-	1.0	1.3	A2	B3	A3	A2	1	-	2	-
CQ72-1-G205K-	2	1.3	A5	C4	A6	A5	1	-	2	-
CQ72-1-G405K-	4	1.3	B6	F1	C2	B6	1	-	2	-
CQ72-1-G605K-	6	1.3	C4	G2	D3	C4	1	-	2	-
CQ72-1-G805K-	8	1.3	D2	J2	D5	D2	1	-	2	-
CQ72-1-G106K-	10	1.3	D5	J5	E5	D5	1	-	2	-
CQ72-1-G126K-	12	1.3	E4	J6	E6	E4	1	-	2	-
CQ72-1-G156K-	15	1.3	F1	J11	G2	F1	1	-	2	-
1,500 DC Voltage Rating (Volt)										
CQ72-1-H104K	0.1	1.3	A1	A1	A2	-	1	-	2	-
CQ72-1-H254K	0.25	1.3	A1	A2	A3	A2	1	-	2	-
CQ72-1-H504K	0.5	1.3	A2	A5	A3	-	1	-	2	-
CQ72-1-H105K	1.0	1.3	A5	B5	A6	A5	1	-	2	-
CQ72-1-H205K	2	1.3	B6	D4	B6	B5	1	-	2	-
CQ72-1-H405K	4	1.3	D5	G4	D4	C4	1	-	2	-
CQ72-1-H605K	6	1.3	G1	J6	E5	D5	1	-	2	-
CQ72-1-H805K	8	1.3	J2	J10	F2	F1	1	-	2	-
CQ72-1-H106K	10	1.3	J4	-	G4	G2	1	-	2	-
CQ72-1-H126K	12	1.3	J6	-	J3	G2	1	-	2	-
CQ72-1-H156K	15	1.3	J10	-	J6	J3	1	-	2	-
2,000 DC Voltage Rating (Volt)										
CQ72E1FJ254K1	0.25	1	-	-	B1	-	-	-	3	-
CQ72E1FJ504K1	0.5	1	-	-	B2	-	-	-	3	-
CQ72E1-J105K	1.0	1.3	-	C3	B6	B3	-	-	3	-
CQ72E1-J205K	2	1.3	C4	E6	C4	C3	-	-	3	-
CQ72E1-J405K	4	1.3	F1	J4	E6	E3	-	-	3	-
CQ72E1-J605K	6	1.3	G3	J8	G4	G1	-	-	3	-
CQ72E1-J805K	8	1.3	J2	-	J4	G3	-	-	3	-
CQ72E1-J106K	10	1.3	J5	-	J7	J3	-	-	3	-
CQ72E1-J126K	12	1.3	J6	-	J9	J5	-	-	3	-
CQ72E1-J156K	15	1.3	J11	-	J10	J7	-	-	3	-
2,500 DC Voltage Rating (Volt)										
CQ72E1FK104K1	0.1	1	-	-	B1	-	-	-	3	-
CQ72E1-K254K	0.25	1	-	-	B2	B1	-	-	3	-
CQ72E1-K504K	0.5	1.3	-	B5	B4	B3	-	-	3	-
CQ72E1-K105K	1.0	1.3	-	D2	D2	D1	-	-	3	-
CQ72E1-K205K	2	1.3	C4	G4	E5	D5	-	-	3	-
CQ72E1-K405K	4	1.3	E6	J8	J2	-	-	-	3	-
CQ72E1-K605K	6	1.3	J2	-	J6	J4	-	-	3	-
CQ72E1-K805K	8	1.3	J5	-	J8	J6	-	-	3	-
CQ72E1-K106K	10	1.3	J7	-	J10	J8	-	-	3	-
CQ72E1-K126K	12	1.3	J11	-	K3	J10	-	-	3	-

RECTANGULAR METAL CASE PAPER / POLYESTER FOIL CAPACITORS

TYPE CQ72

TABLE 2

Part Number	Capacitance μF	Vibration Grade	Case Size Characteristic				Available Terminal Identification No. Terminal			
			E	K	F	G	B	D	E	H
3,000 DC Voltage Rating (Volt)										
CQ72E1-L104K1	0.1	1	-	-	B2	B1	-	-	3	-
CQ72E1-L254K1	0.25	1	-	-	B3	B2	-	-	3	-
CQ72E1-L504K1	0.5	1	-	-	B6	B5	-	-	3	-
CQ72E1-L105K	1.0	1.3	D1	E4	E4	E3	-	-	3	-
CQ72E1-L205K	2	1.3	E2	J2	G2	G1	-	-	3	-
CQ72E1-L405K	4	1.3	G4	J11	J7	J3	-	-	3	-
CQ72E1-L605K	6	1.3	J5	-	K2	J9	-	-	3	-
4,000 DC Voltage Rating (Volt)										
CQ72E1FM104K1	0.1	1	-	-	E1	-	-	-	4	-
CQ72E1-M254K	0.25	1.3	-	C1	E3	E1	-	-	4	-
CQ72E1-M504K	0.5	1.3	-	C4	E5	E3	-	-	4	-
CQ72E1-M105K	1.0	1.3	C2	F2	G2	E6	-	-	4	-
CQ72E1-M205K	2	1.3	E6	J7	J6	J4	-	-	4	-
CQ72E1-M405K	4	1.3	J5	-	J11	J10	-	-	4	-
5,000 DC Voltage Rating (Volt)										
CQ72E1-N104K	0.1	1.3	C1	-	E1	-	-	-	4	-
CQ72E1-N254K	0.25	1.3	C1	-	E3	-	-	-	4	-
CQ72E1-N504K	0.5	1.3	C1	E4	E6	E4	-	-	4	-
CQ72E1-N105K	1.0	1.3	D2	G4	J4	J2	-	-	4	-
CQ72E1-N205K	2	1.3	F2	J11	J11	J6	-	-	4	-
CQ72E1-N405K1	4	1	-	-	K4	K3	-	-	4	-
6,000 DC Voltage Rating (Volt)										
CQ72D1-P104K	0.1	1.3	C1	-	E3	E2	-	4	-	-
CQ72D1-P254K-	0.25	1.3	C1	D2	E5	E4	-	4	-	-
CQ72D1-P504K-	0.5	1.3	C1	E6	J3	J2	-	4	-	-
CQ72D1-P105K-	1.0	1.3	E5	J6	J11	J9	-	4	-	-
CQ72D1-P205K-	2	1.3	G1	-	L1	K3	-	4	-	-
7,500 DC Voltage Rating (Volt)										
CQ72D1-R104K	0.1	1.3	C1	C1	E5	E3	-	4	-	-
CQ72D1-R254K	0.25	1.3	C2	G1	J2	J1	-	4	-	-
CQ72D1-R504K	0.5	1.3	E4	J3	J6	J4	-	4	-	-
CQ72D1-R105K	1.0	1.3	G3	-	K3	-	-	4	-	-
CQ72D1-R205K	2	1.3	J10	-	L2	K4	-	4	-	-
10,000 DC Voltage Rating (Volt)										
CQ72D1-S104K	0.1	1.3	C2	E2	-	-	-	4	-	-
CQ72D1-S254K	0.25	1.3	E3	J3	-	-	-	4	-	-
CQ72-1-S504K	0.5	1.3	F2	J9	K4	K3	-	4	-	5
CQ72-1-S105K	1.0	1.3	J6	-	L2	K4	-	4	-	5
CQ72-1-S205K1	2	1	-	-	M1	L3	-	4	-	5
12,500 DC Voltage Rating (Volt)										
CQ72-1-T104K	0.1	1.3	E2	J1	K1	-	-	4	-	5
CQ72-1-T254K	0.25	1.3	E4	J5	K2	-	-	4	-	5
CQ72-1-T504K	0.5	1.3	J4	-	L1	K4	-	4	-	5
CQ72-1-T105K	1.0	1.3	J10	-	M1	L3	-	4	-	5
CQ72-1-T205K1	2	1	-	-	M2	M1	-	4	-	5

^{1/} Complete part number shall include additional symbols to indicate terminal, characteristic, and vibration grade, as applicable.

RECTANGULAR METAL CASE PAPER / POLYESTER FOIL CAPACITORS

TABLE 3

Case Size ^{1/}	Case Dimensions (in inches)				Retainer Part Number ^{2/}
	W ± 0.062	T ± 0.062	L ± 0.062	A $+0.0625, -0.187$	
A1	1.812	1.062	1.625	0.812	CQ072-A1
A2	1.812	1.062	2.250	0.812	CQ072-A2
A3	1.812	1.062	2.875	0.812	CQ072-A3
A4	1.812	1.062	3.250	0.812	CQ072-A4
A5	1.812	1.062	3.875	0.812	CQ072-A5
A6	1.812	1.062	4.750	0.812	CQ072-A6
B1	2.500	1.188	2.500	1.125	CQ072-B1
B2	2.500	1.188	2.875	1.125	CQ072-B2
B3	2.500	1.188	3.500	1.125	CQ072-B3
B4	2.500	1.188	3.875	1.125	CQ072-B4
B5	2.500	1.188	4.250	1.125	CQ072-B5
B6	2.500	1.188	4.750	1.125	CQ072-B6
C1	3.750	1.250	3.250	2.000	CQ072-C1
C2	3.750	1.250	3.875	2.000	CQ072-C2
C3	3.750	1.250	4.250	2.000	CQ072-C3
C4	3.750	1.250	4.750	2.000	CQ072-C4
D1	3.750	1.750	3.250	2.000	CQ072-D1
D2	3.750	1.750	3.875	2.000	CQ072-D2
D3	3.750	1.750	4.000	2.000	CQ072-D3
D4	3.750	1.750	4.250	2.000	CQ072-D4
D5	3.750	1.750	4.750	2.000	CQ072-D5
E1	3.750	2.250	2.750	2.000	CQ072-E1
E2	3.750	2.250	3.375	2.000	CQ072-E2
E3	3.750	2.250	3.875	2.000	CQ072-E3
E4	3.750	2.250	4.500	2.000	CQ072-E4
E5	3.750	2.250	4.750	2.000	CQ072-E5
E6	3.750	2.250	5.125	2.000	CQ072-E6
F1	3.750	2.500	4.750	2.000	CQ072-F1
F2	3.750	2.500	5.750	2.000	CQ072-F2
G1	3.750	3.188	4.500	2.000	CQ072-G1
G2	3.750	3.188	4.750	2.000	CQ072-G2
G3	3.750	3.188	5.125	2.000	CQ072-G3
G4	3.750	3.188	5.500	2.000	CQ072-G4
J1	4.562	3.750	3.875	2.000	CQ072-J1
J2	4.562	3.750	4.375	2.000	CQ072-J2
J3	4.562	3.750	4.750	2.000	CQ072-J3
J4	4.562	3.750	5.125	2.000	CQ072-J4
J5	4.562	3.750	5.500	2.000	CQ072-J5
J6	4.562	3.750	6.000	2.000	CQ072-J6
J7	4.562	3.750	6.500	2.000	CQ072-J7
J8	4.562	3.750	7.000	2.000	CQ072-J8
J9	4.562	3.750	7.500	2.000	CQ072-J9
J10	4.562	3.750	8.500	2.000	CQ072-J10
J11	4.562	3.750	9.625	2.000	CQ072-J11
K1	8.000	4.000	5.500	4.500	CQ072-K1
K2	8.000	4.000	7.000	4.500	CQ072-K2
K3	8.000	4.000	9.250	4.500	CQ072-K3
K4	8.000	4.000	11.000	4.500	CQ072-K4
L1	13.500	4.125	7.000	6.750	CQ072-L1
L2	13.500	4.125	9.250	6.750	CQ072-L2
L3	13.500	4.125	13.125	6.750	CQ072-L3
M1	13.500	5.125	12.875	6.750	CQ072-M1
M2	13.500	5.125	13.750	6.750	CQ072-M2

^{1/} For case size J, the retainers are attached to the sides of the case which are parallel to the centerline of the terminals.

^{2/} Complete retainer part number will include the symbol "F" for footed or "S" for the spaded design.

For additional information and retainer size refer to MIL-PRF-19978.

NON-HERMETICALLY SEALED CAPACITORS

POLYESTER METALIZED FILM CAPACITORS

Type 430P.....	64
Type 431P.....	66
Type 442P.....	68
Type DPM 90.....	71
Type DPM 907.....	75
Type DPM 907 R1 / R2.....	80
Type DPM 907 N.....	85
Type DPM 90 R1 / R2.....	90
Type DPM 94 / 94N.....	94
Type DPM 948.....	100

POLYESTER FILM / FOIL CAPACITOR

Type 410P.....	108
----------------	-----

POLYPROPYLENE FILM CAPACITORS

METALIZED FILM

Type 709G.....	110
Type 730P / 731P.....	114
Type 730G.....	119
Type 734G.....	122
Type 735P.....	124
Type 744G.....	128
Type 752P.....	130
Type 781P.....	133

POLYPROPYLENE FILM / FOIL CAPACITOR

Type 710P.....	135
----------------	-----

POLYPHENYLENE SULFIDE FILM CAPACITORS

METALIZED FILM

Type 832P.....	137
Type 842P.....	140
Type 880P.....	143
Type DKM 94.....	145

POLYPHENYLENE SULFIDE FILM / FOIL CAPACITORS

Type 810P.....	147
Type 882P.....	149

WRAP-AND-FILL METALIZED POLYESTER FILM CAPACITORS



FEATURES

- 63 VDC to 16,000 VDC
- Extensive standard ratings
- Rugged construction
- Small size

MAJOR APPLICATIONS:

Blocking, filtering, bypass, timing, coupling decoupling, pulse operations, power supply, low to high voltage, copiers, etc.

PHYSICAL CHARACTERISTICS

CONSTRUCTION:

Non-inductive wound metalized polyester.

CASE:

Flame retardant tape wrap and epoxy end fill.

LEAD MATERIAL:

Solder coated solid wire.

LEAD WIRE SIZES:

Case Dia.	Lead AWG
< 0.270	0.025 (No. 22)
≥ 0.270	0.032 (No. 20)

LEAD STRENGTH:

Capable of withstanding a five pound pull force on lead axis.

MARKING:

Dearborn trademark, type or catalog number, capacitance, tolerance and voltage.

ELECTRICAL SPECIFICATIONS

CAPACITANCE RANGE: 0.001 μ F to 10.0 μ F

VOLTAGE RANGE:

- 63 VDC to 16,000 VDC
- 40 VAC to 220 VAC

CAPACITANCE TOLERANCE: \pm 20%, \pm 10%, \pm 5%

OPERATING TEMPERATURE: -55°C to +125°C

VOLTAGE DERATING: At +125°C, 50% of the 85°C rating

DISSIPATION FACTOR:

- 0.8% maximum \leq 1.0 μ F
- 1.0% maximum $>$ 1.0 μ F

VOLTAGE TEST:

200% of rated voltage for 2 minutes. 1kv and greater voltage limited to 120% of rated voltage for 5 min. thru 50,000 ohms minimum.

INSULATION RESISTANCE:

- At +25°C, 25,000 Megaohm-Microfarads, need not exceed 50,000 Megaohms
- At +85°C, 1,000 Megaohm-Microfarads, need not exceed 2,500 Megaohms

DIMENSIONS (in inches)

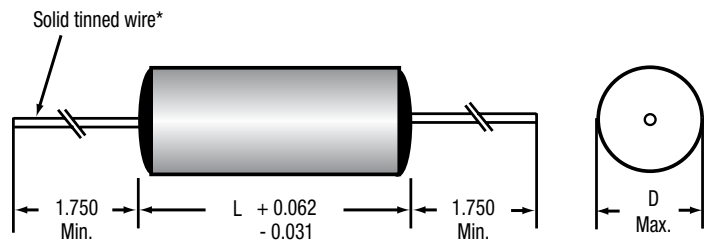

* Leads to be within \pm 0.062" of center line at egress, but not less than 0.031" from edge.

WRAP-AND-FILL METALIZED POLYESTER FILM CAPACITORS

TYPE 430P

MAXIMUM PULSE RISE TIME

Capacitor Length (inch)	Rise Time dv / dt (V / μ s)											
	63 VDC	100 VDC	250 VDC	400 VDC	630 VDC	1,000 VDC	2,000 VDC	4,000 VDC	6,000 VDC	8,000 VDC	10,000 VDC	16,000 VDC
0.625	46	51	75	100	250	-	-	-	-	-	-	-
0.750	28	34	48	75	130	-	-	-	-	-	-	-
1.000	16	19	27	45	75	89	170	-	-	-	-	-
1.125	-	-	-	-	-	-	-	1200	-	-	-	-
1.250	12	13	19	30	45	-	-	-	-	-	-	-
1.500	9	10	15	21	35	-	-	-	2750	-	-	-
1.750	-	9	12	19	25	30	50	450	-	-	-	-
1.875	-	-	-	-	-	-	-	-	-	5000	-	-
2.000	-	-	-	-	25	-	-	-	-	-	-	-
2.250	-	-	-	-	-	-	-	-	-	-	7500	-
2.500	-	-	-	-	-	-	-	-	1000	-	-	-
3.062	-	-	-	-	-	-	-	-	-	-	-	12000
3.187	-	-	-	-	-	-	-	-	-	1900	-	-

STANDARD RATINGS

Capacitance	Voltage Code 063 63 VDC / 40 VAC*		Voltage Code 100 100 VDC / 63 VAC*		Voltage Code 250 250 VDC / 160 VAC*		Voltage Code 400 400 VDC / 200 VAC*		Voltage Code 630 630 VDC / 220 VAC*		Voltage Code 1k0 1,000 VDC		Voltage Code 2k0 2,000 VDC		Voltage Code 4k0 4,000 VDC		Voltage Code 6k0 6,000 VDC		Voltage Code 8k0 8,000 VDC		Voltage Code 10k0 10,000 VDC		Voltage Code 16k0 16,000 VDC		
	μ F	Code	D	L	D	L	D	L	D	L	D	L	D	L	D	L	D	L	D	L	D	L	D	L	D
0.0010	102	-	-	-	-	-	-	-	-	-	-	-	-	0.301	1.125	0.304	1.500	0.294	1.875	0.337	2.250	0.387	3.062	-	-
0.0015	152	-	-	-	-	-	-	-	-	-	-	-	-	0.301	1.125	0.304	1.500	0.342	1.875	0.360	2.250	0.451	3.062	-	-
0.0022	222	-	-	-	-	-	-	-	-	-	-	-	-	0.301	1.125	0.333	1.500	0.371	1.875	0.360	2.250	0.528	3.062	-	-
0.0033	332	-	-	-	-	-	-	-	-	-	-	-	-	0.326	1.125	0.381	1.500	0.371	1.875	0.417	2.250	0.628	3.062	-	-
0.0047	472	-	-	-	-	-	-	-	0.187	0.625	-	-	-	0.326	1.125	0.381	1.500	0.429	1.875	0.480	2.250	0.734	3.062	-	-
0.0068	682	-	-	-	-	-	-	-	0.209	0.625	-	-	-	0.376	1.125	0.445	1.500	0.510	1.875	0.560	2.250	0.868	3.062	-	-
0.010	103	-	-	-	-	-	-	-	0.239	0.625	-	-	-	0.440	1.125	0.531	1.500	0.600	1.875	0.662	2.250	1.040	3.062	-	-
0.015	153	-	-	-	-	-	0.186	0.625	0.224	0.750	-	-	0.309	1.000	0.531	1.125	0.632	1.500	0.717	1.875	0.793	2.250	1.353	3.062	-
0.022	223	-	-	-	-	-	0.210	0.625	0.257	0.750	-	-	0.358	1.000	0.407	1.750	0.749	1.500	0.853	1.875	0.946	2.250	-	-	-
0.033	333	-	-	-	-	-	0.241	0.625	0.300	0.750	-	-	0.421	1.000	0.490	1.750	0.581	2.500	1.030	1.875	-	-	-	-	-
0.047	473	-	-	-	-	0.200	0.625	0.275	0.625	0.269	1.000	0.302	1.000	0.497	1.000	0.568	1.750	0.678	2.500	0.771	1.875	-	-	-	-
0.068	683	-	-	-	-	0.225	0.625	0.266	0.750	0.311	1.000	0.347	1.000	0.581	1.000	0.667	1.750	0.800	2.500	0.913	3.187	-	-	-	-
0.10	104	-	-	0.204	0.625	0.221	0.750	0.310	0.750	0.365	1.000	0.405	1.000	0.413	1.750	0.793	1.750	1.009	2.500	-	-	-	-	-	-
0.15	154	0.210	0.625	0.233	0.625	0.254	0.750	0.293	1.000	0.368	1.250	0.489	1.000	0.498	1.750	0.956	1.750	-	-	-	-	-	-	-	-
0.22	224	0.240	0.625	0.228	0.750	0.295	0.750	0.342	1.000	0.385	1.500	0.574	1.000	0.585	1.750	1.143	1.750	-	-	-	-	-	-	-	-
0.33	334	0.279	0.625	0.264	0.750	0.279	1.000	0.350	1.250	0.428	1.750	0.457	1.750	0.699	1.750	-	-	-	-	-	-	-	-	-	-
0.47	474	0.269	0.750	0.246	1.000	0.321	1.000	0.364	1.500	0.497	1.750	0.528	1.750	-	-	-	-	-	-	-	-	-	-	-	-
0.68	684	0.311	0.750	0.283	1.000	0.375	1.000	0.402	1.750	0.585	1.750	0.618	1.750	-	-	-	-	-	-	-	-	-	-	-	-
1.00	105	0.291	1.000	0.286	1.250	0.380	1.250	0.472	1.750	-	-	0.733	1.750	-	-	-	-	-	-	-	-	-	-	-	-
1.50	155	0.344	1.000	0.351	1.250	0.454	1.250	0.563	1.750	-	-	-	-	-	-	-	-	-	-	-	-	-	-	-	-
2.00	205	0.400	1.000	0.393	1.250	0.469	1.500	0.640	1.750	-	-	-	-	-	-	-	-	-	-	-	-	-	-	-	-
2.50	255	0.438	1.000	0.430	1.250	0.516	1.500	-	-	-	-	-	-	-	-	-	-	-	-	-	-	-	-	-	-
3.00	305	0.398	1.250	0.464	1.250	0.559	1.500	-	-	-	-	-	-	-	-	-	-	-	-	-	-	-	-	-	-
4.00	405	0.434	1.500	0.494	1.500	0.580	1.750	-	-	-	-	-	-	-	-	-	-	-	-	-	-	-	-	-	-
5.00	505	0.476	1.500	0.544	1.500	0.641	1.750	-	-	-	-	-	-	-	-	-	-	-	-	-	-	-	-	-	-
6.00	605	0.515	1.500	0.591	1.500	0.697	1.750	-	-	-	-	-	-	-	-	-	-	-	-	-	-	-	-	-	-
7.00	705	0.551	1.500	0.633	1.500	-	-	-	-	-	-	-	-	-	-	-	-	-	-	-	-	-	-	-	-
10.00	106	0.647	1.500	0.678	1.750	-	-	-	-	-	-	-	-	-	-	-	-	-	-	-	-	-	-	-	-

Additional capacitance values, voltages, and tolerances are available upon request.

*AC voltage rating is at 60Hz 1.4 x VRMS + VDC should not exceed the rated VDC.

WRAP-AND-FILL OVAL CONFIGURATION METALIZED POLYESTER FILM CAPACITORS



FEATURES

- Economical
- Small size
- Rugged construction
- Space saving oval configuration

MAJOR APPLICATIONS:

Blocking, filtering, bypass, timing, coupling decoupling, pulse operations, power supply, etc.

PHYSICAL CHARACTERISTICS

CONSTRUCTION:

Non-inductive wound metalized polyester.

CASE:

Flame retardant tape wrap and epoxy endfill.

LEAD MATERIAL:

Solder coated solid wire.

LEAD WIRE SIZES:

Case Dia.	Lead AWG
≤ 0.240	No. 22
> 0.240	No. 20

LEAD STRENGTH:

Capable of withstanding a five pound pull force on lead axis.

MARKING:

Dearborn trademark, type or catalog number, capacitance, tolerance and voltage.

ELECTRICAL SPECIFICATIONS

CAPACITANCE RANGE: 0.01 μF to 15.0 μF

VOLTAGE RATING:

- 63 VDC to 630 VDC
- 40 VRMS to 220 VRMS

CAPACITANCE TOLERANCE: $\pm 20\%$, $\pm 10\%$, $\pm 5\%$

OPERATING TEMPERATURE: -55°C to $+125^{\circ}\text{C}$

VOLTAGE DERATING: At $+125^{\circ}\text{C}$, 50% of the 85°C rating

DISSIPATION FACTOR:

- 0.8% maximum $\leq 1.0 \mu\text{F}$
- 1.0% maximum $> 1.0 \mu\text{F}$

DC VOLTAGE TEST: 200% of rated voltage for 2 minutes

INSULATION RESISTANCE:

- At $+25^{\circ}\text{C}$, 25,000 Megaohm-Microfarads, need not exceed 50,000 Megaohms
- At $+85^{\circ}\text{C}$, 1,000 Megaohm-Microfarads, need not exceed 2,500 Megaohms

MAXIMUM PULSE RISE TIME

Capacitor Length (inch)	Rise Time dv/dt (V / μs)				
	63 VDC / 40 VAC	100 VDC / 63 VAC	250 VDC / 160 VAC	400 VDC / 200 VAC	630 VDC / 220 VAC
0.625	46	54	75	100	250
0.750	28	34	48	75	130
1.000	16	19	27	45	75
1.250	12	13	19	30	45
1.500	9	10	15	-	37
1.750	9	9	12	19	30
2.000	-	-	-	-	25
2.250	-	7	9	13	-

DIMENSIONS (in inches)

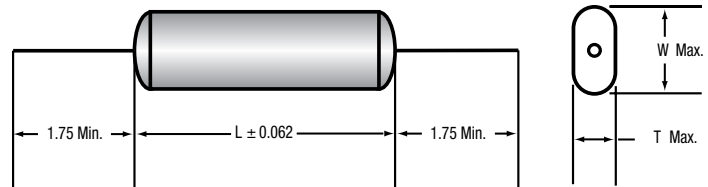

*Leads to be within ± 0.062 " (1.57 mm) of the center line at egress, but not less than 0.031" for the edge.

WRAP-AND-FILL OVAL CONFIGURATION METALIZED POLYESTER FILM CAPACITORS

TYPE 431P

STANDARD RATINGS

Capacitance		Voltage Code 063 63 VDC / 40 VAC*			Voltage Code 100 100 VDC / 63 VAC*			Voltage Code 250 250 VDC / 160 VAC*			Voltage Code 400 400 VDC / 200 VAC*			Voltage Code 630 630 VDC / 220 VAC*		
μF	Code	T	W	L	T	W	L	T	W	L	T	W	L	T	W	L
0.010	103	-	-	-	-	-	-	-	-	-	-	-	-	0.171	0.278	0.625
0.015	153	-	-	-	-	-	-	-	-	-	-	-	-	0.199	0.331	0.625
0.022	223	-	-	-	-	-	-	-	-	-	-	-	-	0.189	0.296	0.750
0.033	333	-	-	-	-	-	-	-	-	-	0.173	0.280	0.625	0.221	0.353	0.750
0.047	473	-	-	-	-	-	-	-	-	-	0.206	0.313	0.625	0.191	0.323	1.000
0.068	683	-	-	-	-	-	-	-	-	-	0.198	0.305	0.750	0.231	0.363	1.000
0.10	104	-	-	-	-	-	-	0.191	0.298	0.625	0.230	0.362	0.750	0.272	0.429	1.000
0.15	154	-	-	-	-	-	-	0.186	0.293	0.750	0.214	0.395	1.000	0.275	0.432	1.250
0.22	224	-	-	-	0.200	0.307	0.625	0.215	0.347	0.750	0.251	0.407	1.000	0.292	0.448	1.500
0.33	334	0.210	0.317	0.625	0.196	0.303	0.750	0.200	0.332	1.000	0.258	0.415	1.250	0.302	0.507	1.750
0.47	474	0.191	0.323	0.750	0.178	0.285	1.000	0.231	0.387	1.000	0.272	0.428	1.500	0.348	0.603	1.750
0.68	684	0.231	0.363	0.750	0.204	0.336	1.000	0.282	0.438	1.000	0.297	0.453	1.750	0.432	0.687	1.750
1.00	105	0.212	0.344	1.000	0.208	0.339	1.250	0.287	0.443	1.250	0.344	0.550	1.750	0.488	0.742	2.000
1.50	155	0.252	0.408	1.000	0.246	0.403	1.250	0.336	0.541	1.250	0.411	0.665	1.750	-	-	-
2.00	205	0.274	0.480	1.000	0.288	0.444	1.250	0.341	0.547	1.500	0.486	0.740	1.750	-	-	-
2.50	255	0.311	0.517	1.000	0.304	0.509	1.250	0.366	0.628	1.500	0.507	0.860	1.750	-	-	-
3.00	305	0.283	0.488	1.250	0.337	0.542	1.250	0.407	0.662	1.500	0.467	0.820	2.250	-	-	-
4.00	405	0.307	0.513	1.250	0.345	0.600	1.500	0.427	0.682	1.750	0.557	0.910	2.250	-	-	-
5.00	505	0.349	0.554	1.500	0.393	0.648	1.500	0.486	0.741	1.750	-	-	-	-	-	-
6.00	605	0.365	0.620	1.500	0.437	0.692	1.500	0.496	0.848	1.750	-	-	-	-	-	-
7.00	705	0.400	0.654	1.500	0.479	0.733	1.500	0.544	0.897	1.750	-	-	-	-	-	-
10.00	106	0.492	0.747	1.500	0.478	0.831	1.750	0.558	0.910	2.250	-	-	-	-	-	-
12.00	126	0.496	0.740	1.750	0.483	0.738	2.250	0.622	0.975	2.250	-	-	-	-	-	-
15.00	156	0.507	0.860	1.750	0.505	0.857	2.250	-	-	-	-	-	-	-	-	-

Additional capacitance values, voltages, and tolerances are available upon request.

*AC voltage rating is at 60Hz 1.4 x VRMS + VDC should not exceed the rated VDC.

WRAP-AND-FILL METALIZED POLYESTER FILM CAPACITORS



FEATURES

- Smallest polyester capacitor available
- Wide temperature range
- Rated for DC and AC operation
- Capacitance values to 10 μF

MAJOR APPLICATIONS:

Blocking, filtering, bypass, timing, coupling decoupling, pulse operations, power supplies.

PHYSICAL CHARACTERISTICS

CONSTRUCTION:

Non-inductive wound metalized polyester.

CASE: Flame retardant tape wrap and epoxy endfill.

LEAD MATERIAL: Solder coated solid wire.

LEAD WIRE SIZES:

Case Dia.	Lead AWG
< 0.270	0.025 (No. 22)
\geq 0.270	0.032 (No. 20)

LEAD STRENGTH:

Capable of withstanding a five pound pull force on lead axis.

MARKING:

Dearborn trademark, type or catalog number, capacitance, tolerance and voltage.

ELECTRICAL SPECIFICATIONS

CAPACITANCE RANGE: 0.01 μF to 10.0 μF

VOLTAGE RATING:

- 63 VDC to 400 VDC
- 40 VAC to 200 VAC

CAPACITANCE TOLERANCE: $\pm 10\%$, $\pm 5\%$, $\pm 2\%$

OPERATING TEMPERATURE: -55°C to $+125^{\circ}\text{C}$

VOLTAGE DERATING: At $+125^{\circ}\text{C}$, 50% of the 85°C rating

DISSIPATION FACTOR: 0.9% maximum

DC VOLTAGE TEST: 200% of rated voltage for 2 minutes

INSULATION RESISTANCE:

- At $+25^{\circ}\text{C}$, 25,000 Megaohm-Microfarads, need not exceed 50,000 Megaohms
- At $+85^{\circ}\text{C}$, 1,000 Megaohm-Microfarads, need not exceed 2,500 Megaohms

MAXIMUM PULSE RISE TIME

Capacitor Length (inch)	Rise Time dv / dt (V / μs)			
	63 VDC	100 VDC	250 VDC	400 VDC
0.450	20	40	80	-
0.580	15	20	40	80
0.700	10	15	-	50
0.830	8	10	20	40
1.00	6	8	15	30
1.20	-	6	10	20
1.50	-	-	-	15
1.70	-	-	8	-
1.95	-	-	8	10

DIMENSIONS (in inches)

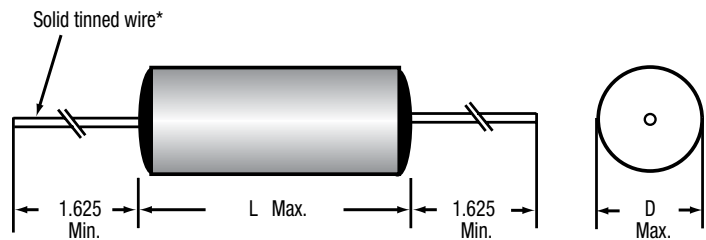

*Leads to be within $\pm 0.062"$ (1.57 mm) of the center line at egress, but not less than 0.031" for the edge.

WRAP-AND-FILL METALIZED POLYESTER FILM CAPACITORS

TYPE 442P

STANDARD RATINGS

Capacitance		Voltage Code 063 63 VDC / 40 VAC*		Voltage Code 100 100 VDC / 63 VAC*		Voltage Code 250 250 VDC / 160 VAC*		Voltage Code 400 400 VDC / 200 VAC*	
µF	Code	D	L	D	L	D	L	D	L
0.010	103	-	-	-	-	0.200	0.450	0.200	0.580
0.015	153	-	-	-	-	0.200	0.450	0.200	0.580
0.022	223	-	-	-	-	0.200	0.450	0.230	0.580
0.033	333	-	-	-	-	0.200	0.450	0.270	0.580
0.047	473	-	-	-	-	0.230	0.450	0.300	0.580
0.068	683	-	-	0.200	0.450	0.230	0.580	0.290	0.700
0.10	104	-	-	0.200	0.450	0.270	0.580	0.330	0.700
0.15	154	-	-	0.210	0.450	0.310	0.580	0.340	0.830
0.22	224	0.200	0.450	0.240	0.450	0.340	0.580	0.400	0.830
0.33	334	0.230	0.450	0.230	0.580	0.340	0.830	0.430	1.00
0.47	474	0.260	0.450	0.260	0.580	0.390	0.830	0.440	1.20
0.68	684	0.240	0.580	0.290	0.580	0.370	1.00	0.510	1.20
1.00	105	0.280	0.580	0.350	0.580	0.430	1.00	0.600	1.20
1.50	155	0.320	0.580	0.360	0.700	0.510	1.00	0.640	1.50
2.20	225	0.380	0.580	0.380	0.830	0.530	1.20	0.650	1.95
3.30	335	0.380	0.700	0.460	0.830	0.630	1.20	0.780	1.95
5.00	505	0.460	0.700	0.510	1.00	0.740	1.20	0.910	1.95
6.00	605	0.500	0.830	0.440	1.20	0.640	1.70	-	-
8.00	805	0.510	1.00	0.500	1.20	0.690	1.95	-	-
10.00	106	0.560	1.00	0.620	1.20	0.860	1.95	-	-

Additional capacitance values, voltages, and tolerances are available upon request.

* AC voltage rating is at 60Hz 1.4 x VRMS + VDC should not exceed the rated VDC.

* Graphs of AC voltage vs. frequency follow.

WRAP-AND-FILL METALIZED POLYESTER FILM CAPACITORS

VOLTAGE VS. FREQUENCY TYPE 442P

63 VDC / 40 VAC

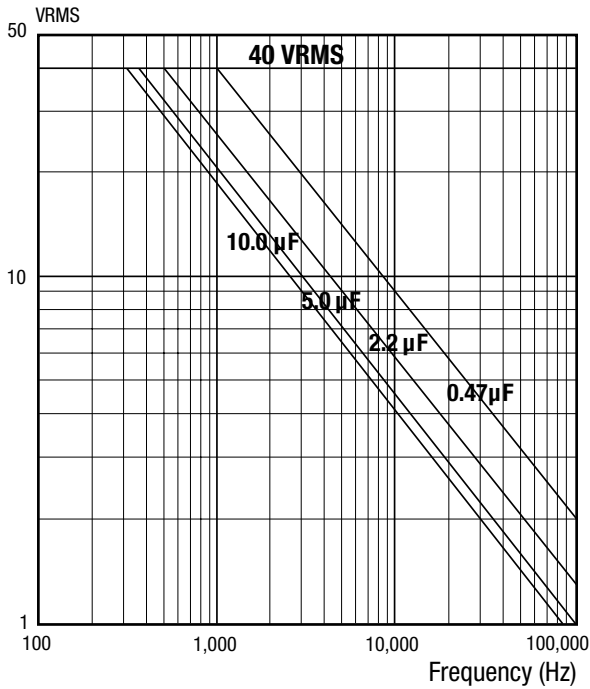

VOLTAGE VS. FREQUENCY TYPE 442P

100 VDC / 63 VAC

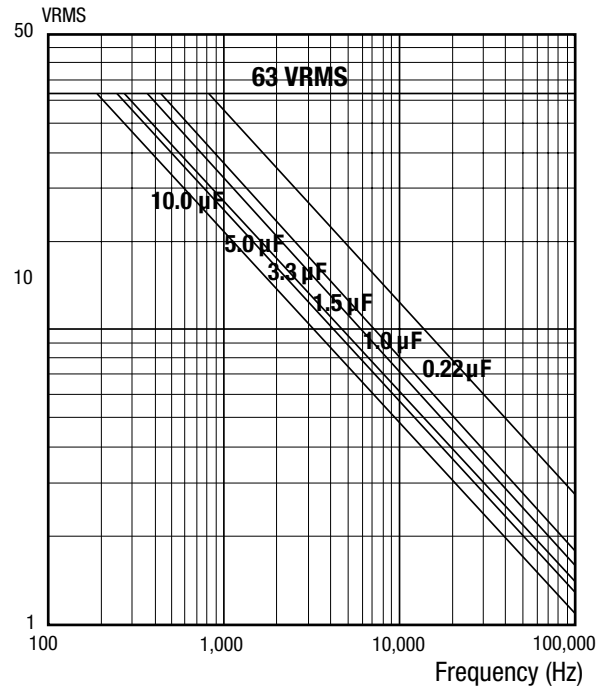

VOLTAGE VS. FREQUENCY TYPE 442P

250 VDC / 160 VAC

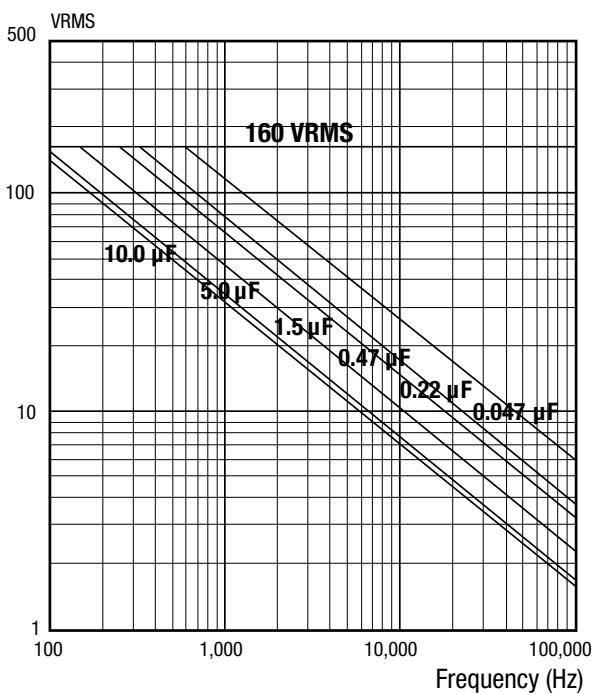

VOLTAGE VS. FREQUENCY TYPE 442P

400 VDC / 200 VAC

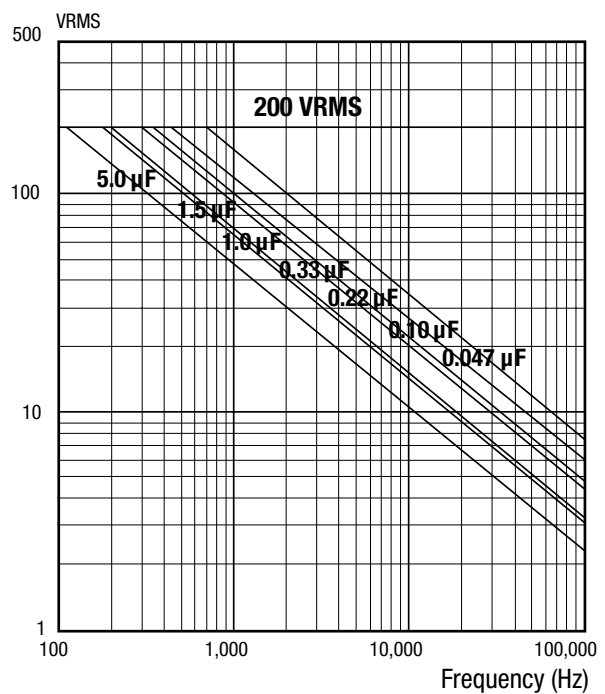

CAPACITORS FOR HIGH FREQUENCY SWITCH MODE POWER SUPPLIES

TYPE DPM 90



PHYSICAL CHARACTERISTICS

CONSTRUCTION:

Dielectric: Metalized Polyester (P.E.T.). Self healing, non-inductive.

CASE:

Thermoplastic case. Epoxy resin sealed.

LEAD MATERIAL:

DPM 90 - Radial leads.

MARKING:

Dearborn trademark, type or catalog number, capacitance, tolerance and voltage.

ELECTRICAL SPECIFICATIONS

OPERATING TEMPERATURE RANGE:

-55°C to +125°C

DISSIPATION FACTOR:

Maximum 1% @ 1kHz

INSULATION RESISTANCE:

$\geq 3,750 \text{ M}\Omega$ for $C_R \leq 0.33$ and $\leq 100 \text{ VDC}$

$\geq 7,500 \text{ M}\Omega$ for $C_R \leq 0.33$ and $> 100 \text{ VDC}$

$\geq 1,250 \text{ M}\Omega \cdot \mu\text{F}$ for $C_R > 0.33$ and $\leq 100 \text{ VDC}$

$\geq 2,500 \text{ M}\Omega \cdot \mu\text{F}$ for $C_R > 0.33$ and $> 100 \text{ VDC}$

DIELECTRIC WITHSTANDING VOLTAGE (DWV):

1.6 x rated voltage

INSULATION BETWEEN LEADS & CASE:

50,000 $\text{M}\Omega$

PERMISSIBLE CURRENT:

@ 300kHz up to 105°C = I_{rms}

@ 300kHz at 125°C = $0.1 I_{\text{rms}}$

AVAILABLE CAPACITANCE TOLERANCES:

$\pm 20\%$ & $\pm 10\%$

DIMENSIONS (in inches)

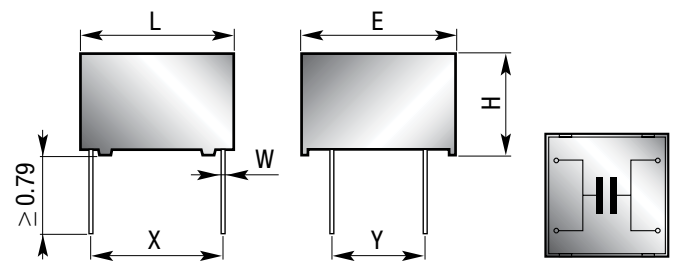

CAPACITORS FOR HIGH FREQUENCY SWITCH MODE POWER SUPPLIES

STANDARD RATINGS

Capacitance		Dimensions (in inches)						TYPE DPM 90 M	TYPE DPM 90					
μF	Code	Max. "L"	Max. "E"	Max. "H"	"X" + / - 0.02	"Y" + / - 0.02	"W" +10% -0.02	50 V (l. rms)	50 V (l. rms)	100 V (l. rms)	200 V (l. rms)	250 V (l. rms)	400 V (l. rms)	630 V (l. rms)
0.22	224	0.807	0.807	0.256	0.701	0.4	0.04	-	0.9	0.9	0.9	0.9	0.9	0.9
0.27	274	0.807	0.807	0.256	0.701	0.4	0.04	-	1.1	1.1	1.1	1.1	1.1	1.1
0.39	394	0.807	0.807	0.256	0.701	0.4	0.04	-	1.25	1.25	1.25	1.25	1.25	-
0.47	474	0.807	0.807	0.256	0.701	0.4	0.04	-	1.6	1.6	1.6	1.6	1.6	-
0.56	564	0.807	0.807	0.256	0.701	0.4	0.04	-	2	2	2	2	2	-
0.68	684	0.807	0.807	0.256	0.701	0.4	0.04	-	2.5	2.5	2.5	2.5	2.5	-
0.82	824	0.807	0.807	0.256	0.701	0.4	0.04	-	3.15	3.15	3.15	3.15	3.15	-
1	105	0.807	0.807	0.256	0.701	0.4	0.04	-	1.25	1.25	1.25	1.25	-	-
1.2	125	0.807	0.807	0.256	0.701	0.4	0.04	-	1.6	1.6	1.6	1.6	-	-
1.5	155	0.807	0.807	0.256	0.701	0.4	0.04	-	1.5	1.5	1.5	2	-	-
1.8	185	0.807	0.807	0.256	0.701	0.4	0.04	-	2.5	2.5	2.5	2.5	-	-
2.2	225	0.807	0.807	0.256	0.701	0.4	0.04	-	2.2	2.2	2.2	3.15	-	-
2.7	275	0.807	0.807	0.256	0.701	0.4	0.04	-	4	4	4	4	-	-
3.3	335	0.807	0.807	0.256	0.701	0.4	0.04	-	2	2	2.6	-	-	-
3.9	395	0.807	0.807	0.256	0.701	0.4	0.04	-	2.5	2.5	-	-	-	-
4.7	475	0.807	0.807	0.256	0.701	0.4	0.04	-	3.15	3.15	-	-	-	-
5.6	565	0.807	0.807	0.256	0.701	0.4	0.04	-	4	4	-	-	-	-
6.8	685	0.807	0.807	0.256	0.701	0.4	0.04	-	5	5	-	-	-	-
8.2	825	0.807	0.807	0.256	0.701	0.4	0.04	-	4	-	-	-	-	-
10	106	0.807	0.807	0.256	0.701	0.4	0.04	-	5	-	-	-	-	-
12	126	0.807	0.807	0.256	0.701	0.4	0.04	-	6.3	-	-	-	-	-
15	156	0.807	0.807	0.256	0.701	0.4	0.04	5.2	-	-	-	-	-	-
0.33	334	0.807	0.807	0.315	0.701	0.4	0.04	-	1.4	1.4	1.4	1.4	1.4	1.4
0.39	394	0.807	0.807	0.315	0.701	0.4	0.04	-	1.6	1.6	1.6	1.6	1.6	1.6
1	105	0.807	0.807	0.315	0.701	0.4	0.04	-	4	4	4	4	4	-
1.2	125	0.807	0.807	0.315	0.701	0.4	0.04	-	4	4	4	4	4	-
3.3	335	0.807	0.807	0.315	0.701	0.4	0.04	-	5	5	5	5	-	-
3.9	395	0.807	0.807	0.315	0.701	0.4	0.04	-	3.1	3.1	3.1	5	-	-
4.7	475	0.807	0.807	0.315	0.701	0.4	0.04	-	3.7	3.7	3.7	-	-	-
8.2	825	0.807	0.807	0.315	0.701	0.4	0.04	-	6.5	6.5	-	-	-	-
15	156	0.807	0.807	0.315	0.701	0.4	0.04	-	8	-	-	-	-	-
18	186	0.807	0.807	0.315	0.701	0.4	0.04	6.2	-	-	-	-	-	-
22	226	0.807	0.807	0.315	0.701	0.4	0.04	7.6	-	-	-	-	-	-
0.47	474	0.807	0.807	0.492	0.701	0.4	0.04	-	1.9	1.9	1.9	1.9	1.9	1.9
0.68	684	0.807	0.807	0.492	0.701	0.4	0.04	-	2.8	2.8	2.8	2.8	2.8	2.8
1.5	155	0.807	0.807	0.492	0.701	0.4	0.04	-	5	5	5	5	5	-
1.8	185	0.807	0.807	0.492	0.701	0.4	0.04	-	5	5	5	5	5	-
4.7	475	0.807	0.807	0.492	0.701	0.4	0.04	-	6.3	6.3	6.3	6.3	-	-
5.6	565	0.807	0.807	0.492	0.701	0.4	0.04	-	4.4	4.4	4.4	6.3	-	-
6.8	685	0.807	0.807	0.492	0.701	0.4	0.04	-	5.4	5.4	5.4	-	-	-
10	106	0.807	0.807	0.492	0.701	0.4	0.04	-	8	8	-	-	-	-
12	126	0.807	0.807	0.492	0.701	0.4	0.04	-	8	8	-	-	-	-
18	186	0.807	0.807	0.492	0.701	0.4	0.04	-	10	-	-	-	-	-
22	226	0.807	0.807	0.492	0.701	0.4	0.04	-	10	-	-	-	-	-
27	276	0.807	0.807	0.492	0.701	0.4	0.04	9.4	-	-	-	-	-	-
33	336	0.807	0.807	0.492	0.701	0.4	0.04	11.5	-	-	-	-	-	-

RMS current rated at 300kHz up to 105°C.

CAPACITORS FOR HIGH FREQUENCY SWITCH MODE POWER SUPPLIES

TYPE DPM 90

STANDARD RATINGS

Capacitance		Dimensions (in inches)						TYPE DPM 90 M	TYPE DPM 90					
μF	Code	Max. "L"	Max. "E"	Max. "H"	"X" +/- 0.02	"Y" +/- 0.02	"W" +10% -0.02	50 V (l. rms)	50 V (l. rms)	100 V (l. rms)	200 V (l. rms)	250 V (l. rms)	400 V (l. rms)	630 V (l. rms)
0.82	824	0.807	0.807	0.788	0.701	0.4	0.04	-	3.4	3.4	3.4	3.4	3.4	3.4
1	105	0.807	0.807	0.788	0.701	0.4	0.04	-	4.1	4.1	4.1	4.1	4.1	4.1
2.2	225	0.807	0.807	0.788	0.701	0.4	0.04	-	6.3	6.3	6.3	6.3	6.3	-
2.7	275	0.807	0.807	0.788	0.701	0.4	0.04	-	6.3	6.3	6.3	6.3	6.3	-
3.3	335	0.807	0.807	0.788	0.701	0.4	0.04	-	6.3	6.3	6.3	6.3	6.3	-
6.8	685	0.807	0.807	0.788	0.701	0.4	0.04	-	8	8	8	8	-	-
8.2	825	0.807	0.807	0.788	0.701	0.4	0.04	-	6.5	6.5	6.5	8	-	-
10	106	0.807	0.807	0.788	0.701	0.4	0.04	-	7.9	7.9	7.9	8	-	-
12	126	0.807	0.807	0.788	0.701	0.4	0.04	-	12	12	9.5	-	-	-
15	156	0.807	0.807	0.788	0.701	0.4	0.04	-	10	10	-	-	-	-
18	186	0.807	0.807	0.788	0.701	0.4	0.04	-	10	10	-	-	-	-
22	226	0.807	0.807	0.788	0.701	0.4	0.04	-	10	10	-	-	-	-
27	276	0.807	0.807	0.788	0.701	0.4	0.04	-	12.5	-	-	-	-	-
33	336	0.807	0.807	0.788	0.701	0.4	0.04	-	12.5	-	-	-	-	-
39	396	0.807	0.807	0.788	0.701	0.4	0.04	-	12.5	-	-	-	-	-
47	476	0.807	0.807	0.788	0.701	0.4	0.04	12.5	-	-	-	-	-	-
56	566	0.807	0.807	0.788	0.701	0.4	0.04	12.5	-	-	-	-	-	-
68	686	0.807	0.807	0.788	0.701	0.4	0.04	12.5	-	-	-	-	-	-
1.2	125	0.807	0.807	1.181	0.701	0.4	0.04	-	5	5	5	5	5	5
1.5	155	0.807	0.807	1.181	0.701	0.4	0.04	-	6.2	6.2	6.2	6.2	6.2	6.2
1.8	185	0.807	0.807	1.181	0.701	0.4	0.04	-	7.4	7.4	7.4	7.4	7.4	7.4
3.9	395	0.807	0.807	1.181	0.701	0.4	0.04	-	8	8	8	8	8	-
4.7	475	0.807	0.807	1.181	0.701	0.4	0.04	-	8	8	8	8	8	-
12	126	0.807	0.807	1.181	0.701	0.4	0.04	-	10	10	10	10	-	-
15	156	0.807	0.807	1.181	0.701	0.4	0.04	-	11.9	11.9	11.9	10	-	-
18	186	0.807	0.807	1.181	0.701	0.4	0.04	-	12.5	12.5	12.5	-	-	-
27	276	0.807	0.807	1.181	0.701	0.4	0.04	-	12.5	12.5	-	-	-	-
33	336	0.807	0.807	1.181	0.701	0.4	0.04	-	12.5	12.5	-	-	-	-
47	476	0.807	0.807	1.181	0.701	0.4	0.04	-	12.5	-	-	-	-	-
56	566	0.807	0.807	1.181	0.701	0.4	0.04	-	12.5	-	-	-	-	-
82	826	0.807	0.807	1.181	0.701	0.4	0.04	12.5	-	-	-	-	-	-
100	1007	0.807	0.807	1.181	0.701	0.4	0.04	12.5	-	-	-	-	-	-
2.2	225	1.24	1.28	0.866	1.1	0.6	0.04	-	5.2	5.2	5.2	5.2	5.2	5.2
2.7	275	1.24	1.28	0.866	1.1	0.6	0.04	-	6.4	6.4	6.4	6.4	6.4	6.4
3.3	335	1.24	1.28	0.866	1.1	0.6	0.04	-	7.8	7.8	7.8	7.8	7.8	7.8
3.9	395	1.24	1.28	0.866	1.1	0.6	0.04	-	9.2	9.2	9.2	9.2	9.2	9.2
5.6	565	1.24	1.28	0.866	1.1	0.6	0.04	-	7.9	7.9	7.9	7.9	7.9	-
6.8	685	1.24	1.28	0.866	1.1	0.6	0.04	-	9.6	9.6	9.6	9.6	9.6	-
8.2	825	1.24	1.28	0.866	1.1	0.6	0.04	-	11.5	11.5	11.5	11.5	11.5	-
10	106	1.24	1.28	0.866	1.1	0.6	0.04	-	14	14	14	14	14	-
18	186	1.24	1.28	0.866	1.1	0.6	0.04	-	15	15	15	15	-	-
22	226	1.24	1.28	0.866	1.1	0.6	0.04	-	9.9	9.9	9.9	15	-	-
27	276	1.24	1.28	0.866	1.1	0.6	0.04	-	15	15	15	15	-	-
33	336	1.24	1.28	0.866	1.1	0.6	0.04	-	14.9	14.9	14.9	-	-	-
39	396	1.24	1.28	0.866	1.1	0.6	0.04	-	15	15	-	-	-	-
47	476	1.24	1.28	0.866	1.1	0.6	0.04	-	15	15	-	-	-	-
56	566	1.24	1.28	0.866	1.1	0.6	0.04	-	15	15	-	-	-	-
68	686	1.24	1.28	0.866	1.1	0.6	0.04	-	15	-	-	-	-	-
82	826	1.24	1.28	0.866	1.1	0.6	0.04	-	15	-	-	-	-	-
100	1007	1.24	1.28	0.866	1.1	0.6	0.04	-	15	-	-	-	-	-

RMS current rated at 300kHz up to 105°C.

CAPACITORS FOR HIGH FREQUENCY SWITCH MODE POWER SUPPLIES

STANDARD RATINGS

Capacitance		Dimensions (in inches)						TYPE DPM 90 M	TYPE DPM 90					
μF	Code	Max. "L"	Max. "E"	Max. "H"	"X" + / - 0.02	"Y" + / - 0.02	"W" +10% -0.02	50 V (l. rms)	50 V (l. rms)	100 V (l. rms)	200 V (l. rms)	250 V (l. rms)	400 V (l. rms)	630 V (l. rms)
4.7	475	1.24	1.28	1.26	1.1	0.6	0.04	-	11	11	11	11	11	11
5.6	565	1.24	1.28	1.26	1.1	0.6	0.04	-	12.5	12.5	12.5	12.5	12.5	12.5
12	126	1.24	1.28	1.26	1.1	0.6	0.04	-	15	15	15	15	15	-
15	156	1.24	1.28	1.26	1.1	0.6	0.04	-	15	15	15	15	15	-
33	336	1.24	1.28	1.26	1.1	0.6	0.04	-	15	15	15	15	-	-
39	396	1.24	1.28	1.26	1.1	0.6	0.04	-	15	15	15	15	-	-
47	476	1.24	1.28	1.26	1.1	0.6	0.04	-	15	15	15	-	-	-
56	566	1.24	1.28	1.26	1.1	0.6	0.04	-	15	15	15	-	-	-
68	686	1.24	1.28	1.26	1.1	0.6	0.04	-	15	15	-	-	-	-
82	826	1.24	1.28	1.26	1.1	0.6	0.04	-	15	15	-	-	-	-
100	1007	1.24	1.28	1.26	1.1	0.6	0.04	-	15	15	-	-	-	-
120	1207	1.24	1.28	1.26	1.1	0.6	0.04	-	15	-	-	-	-	-
150	1507	1.24	1.28	1.26	1.1	0.6	0.04	-	15	-	-	-	-	-

RMS current rated at 300kHz up to 105°C.

CAPACITORS FOR HIGH FREQUENCY SWITCH MODE POWER SUPPLIES

TYPE DPM 907



PHYSICAL CHARACTERISTICS

CONSTRUCTION:

Dielectric: Metalized polyethylene terephthalate. Self healing, low inductance.

CASE:

Thermoplastic case. Epoxy resin molded.

LEAD MATERIAL:

DPM 907 - Termination are radial leads.

MARKING:

Dearborn trademark, type or catalog number, capacitance, tolerance and voltage.

ELECTRICAL SPECIFICATIONS

OPERATING TEMPERATURE RANGE:

-55°C to +125°C

DISSIPATION FACTOR:

Maximum 1% @ 1kHz

INSULATION RESISTANCE:

$\geq 7,500 \text{ M}\Omega$ for $C_R \leq 0.33 \mu\text{F}$

$\geq 2,500 \text{ M}\Omega \cdot \mu\text{F}$ for $C_R > 0.33 \mu\text{F}$

DIELECTRIC WITHSTANDING VOLTAGE (DWV):

1.6 x rated voltage

INSULATION BETWEEN LEADS & CASE:

50,000 $\text{M}\Omega$

PERMISSIBLE CURRENT:

@ 300kHz up to 105°C = 1. $_{\text{rms}}$

@ 300kHz at 125°C = 0.11. $_{\text{rms}}$

AVAILABLE CAPACITANCE TOLERANCES:

$\pm 20\%$ & $\pm 10\%$

DIMENSIONS (in inches)

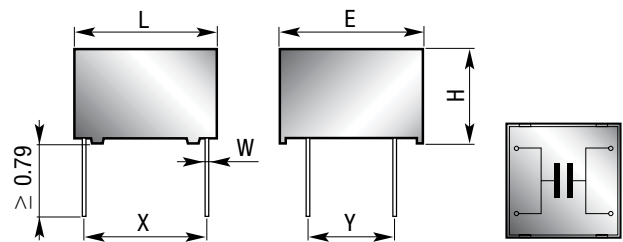

CAPACITORS FOR HIGH FREQUENCY SWITCH MODE POWER SUPPLIES

STANDARD RATINGS

Capacitance		Dimensions (in inches)						TYPE DPM 907									
μF	Code	Max. "L"	Max. "E"	Max. "H"	"X" +/- 0.02	"Y" +/- 0.02	"W" Gauge	63 V (l. rms)	100 V (l. rms)	160 V (l. rms)	250 V (l. rms)	400 V (l. rms)	500 V (l. rms)	630 V (l. rms)	800 V (l. rms)	1,000 V (l. rms)	1,250 V (l. rms)
0.22	224	0.807	0.807	0.256	0.701	0.4	18	0.8	0.8	0.8	0.8	0.8	0.8	0.8	0.9	-	-
0.27	274	0.807	0.807	0.256	0.701	0.4	18	0.9	0.9	0.9	0.9	0.9	0.9	0.9	-	-	-
0.33	334	0.807	0.807	0.256	0.701	0.4	18	1.1	1.1	1.1	1.1	1.1	1.1	1.1	-	-	-
0.39	394	0.807	0.807	0.256	0.701	0.4	18	1.1	1.1	1.1	1.1	1.1	1.1	1.3	-	-	-
0.47	474	0.807	0.807	0.256	0.701	0.4	18	1.3	1.3	1.3	1.3	1.3	1.3	-	-	-	-
0.56	564	0.807	0.807	0.256	0.701	0.4	18	1.5	1.5	1.5	1.5	1.5	1.5	-	-	-	-
0.68	684	0.807	0.807	0.256	0.701	0.4	18	1.9	1.9	1.9	1.9	1.9	1.9	-	-	-	-
0.82	824	0.807	0.807	0.256	0.701	0.4	18	2.5	2.5	2.5	2.5	2.5	-	-	-	-	-
1	105	0.807	0.807	0.256	0.701	0.4	18	3.1	3.1	3.1	3.1	3.1	-	-	-	-	-
1.5	155	0.807	0.807	0.256	0.701	0.4	18	1.5	1.5	1.5	1.5	-	-	-	-	-	-
2.2	225	0.807	0.807	0.256	0.701	0.4	18	2.2	2.2	2.2	2.2	-	-	-	-	-	-
2.7	275	0.807	0.807	0.256	0.701	0.4	18	2.4	2.4	2.4	2.4	-	-	-	-	-	-
3.3	335	0.807	0.807	0.256	0.701	0.4	18	2	2	2	-	-	-	-	-	-	-
3.9	395	0.807	0.807	0.256	0.701	0.4	18	2.5	2.5	2.5	-	-	-	-	-	-	-
4.7	475	0.807	0.807	0.256	0.701	0.4	18	2.5	2.5	3.1	-	-	-	-	-	-	-
5.6	565	0.807	0.807	0.256	0.701	0.4	18	3.2	3.2	3.2	-	-	-	-	-	-	-
6.8	685	0.807	0.807	0.256	0.701	0.4	18	4.3	4.3	4.3	-	-	-	-	-	-	-
8.2	825	0.807	0.807	0.256	0.701	0.4	18	3.2	3.2	5.2	-	-	-	-	-	-	-
10	106	0.807	0.807	0.256	0.701	0.4	18	4	-	-	-	-	-	-	-	-	-
12	126	0.807	0.807	0.256	0.701	0.4	18	5	-	-	-	-	-	-	-	-	-
0.082	823	0.807	0.807	0.315	0.701	0.4	18	0.5	0.5	0.5	0.5	0.5	0.5	0.5	0.5	0.5	0.5
0.1	104	0.807	0.807	0.315	0.701	0.4	18	0.7	0.7	0.7	0.7	0.7	0.7	0.7	0.7	0.7	0.7
0.15	154	0.807	0.807	0.315	0.701	0.4	18	0.8	0.8	0.8	0.8	0.8	0.8	0.8	0.8	0.8	-
0.22	224	0.807	0.807	0.315	0.701	0.4	18	1.1	1.1	1.1	1.1	1.1	1.1	1.1	1.1	1.1	-
0.27	274	0.807	0.807	0.315	0.701	0.4	18	1.1	1.1	1.1	1.1	1.1	1.1	1.1	1.1	-	-
0.33	334	0.807	0.807	0.315	0.701	0.4	18	1.4	1.4	1.4	1.4	1.4	1.4	1.4	1.4	-	-
0.47	474	0.807	0.807	0.315	0.701	0.4	18	1.6	1.6	1.6	1.6	1.6	1.6	1.6	-	-	-
0.56	564	0.807	0.807	0.315	0.701	0.4	18	2	2	2	2	2	2	2	-	-	-
0.82	824	0.807	0.807	0.315	0.701	0.4	18	2.3	2.3	2.3	2.3	2.3	2.3	-	-	-	-
1	105	0.807	0.807	0.315	0.701	0.4	18	2.8	2.8	2.8	2.8	2.8	2.8	-	-	-	-
1.2	125	0.807	0.807	0.315	0.701	0.4	18	3.2	3.2	3.2	3.2	3.2	-	-	-	-	-
1.5	155	0.807	0.807	0.315	0.701	0.4	18	4	4	4	4	4	-	-	-	-	-
3.3	335	0.807	0.807	0.315	0.701	0.4	18	2.6	2.6	2.6	2.6	-	-	-	-	-	-
5.6	565	0.807	0.807	0.315	0.701	0.4	18	4	4	4	-	-	-	-	-	-	-
6.8	685	0.807	0.807	0.315	0.701	0.4	18	5	5	5	-	-	-	-	-	-	-
10	106	0.807	0.807	0.315	0.701	0.4	18	6.4	6.4	-	-	-	-	-	-	-	-
15	156	0.807	0.807	0.315	0.701	0.4	18	6.3	-	-	-	-	-	-	-	-	-

RMS current rated at 300kHz up to 105°C.

CAPACITORS FOR HIGH FREQUENCY SWITCH MODE POWER SUPPLIES

TYPE DPM 907

STANDARD RATINGS

Capacitance		Dimensions (in inches)						TYPE DPM 907									
μF	Code	Max. "L"	Max. "E"	Max. "H"	"X" +/- 0.02	"Y" +/- 0.02	"W" Gauge	63 V (l. rms)	100 V (l. rms)	160 V (l. rms)	250 V (l. rms)	400 V (l. rms)	500 V (l. rms)	630 V (l. rms)	800 V (l. rms)	1,000 V (l. rms)	1,250 V (l. rms)
0.12	124	0.807	0.807	0.492	0.701	0.4	18	0.8	0.8	0.8	0.8	0.8	0.8	0.8	0.8	0.8	0.8
0.15	154	0.807	0.807	0.492	0.701	0.4	18	1	1	1	1	1	1	1	1	1	1
0.18	184	0.807	0.807	0.492	0.701	0.4	18	1.2	1.2	1.2	1.2	1.2	1.2	1.2	1.2	1.2	1.2
0.22	224	0.807	0.807	0.492	0.701	0.4	18	1.5	1.5	1.5	1.5	1.5	1.5	1.5	1.5	1.5	1.5
0.27	274	0.807	0.807	0.492	0.701	0.4	18	1.4	1.4	1.4	1.4	1.4	1.4	1.4	1.4	1.4	-
0.33	334	0.807	0.807	0.492	0.701	0.4	18	1.7	1.7	1.7	1.7	1.7	1.7	1.7	1.7	1.7	-
0.39	394	0.807	0.807	0.492	0.701	0.4	18	1.6	1.6	1.6	1.6	1.6	1.6	1.6	1.6	2	-
0.47	474	0.807	0.807	0.492	0.701	0.4	18	1.9	1.9	1.9	1.9	1.9	1.9	1.9	1.9	-	-
0.56	564	0.807	0.807	0.492	0.701	0.4	18	2.3	2.3	2.3	2.3	2.3	2.3	2.3	2.3	-	-
0.68	684	0.807	0.807	0.492	0.701	0.4	18	2.5	2.5	2.5	2.5	2.5	2.5	2.5	2.8	-	-
0.82	824	0.807	0.807	0.492	0.701	0.4	18	3	3	3	3	3	3	3	-	-	-
1	105	0.807	0.807	0.492	0.701	0.4	18	3.2	3.2	3.2	3.2	3.2	3.2	3.2	-	-	-
1.2	125	0.807	0.807	0.492	0.701	0.4	18	3.3	3.3	3.3	3.3	3.3	-	-	-	-	-
1.5	155	0.807	0.807	0.492	0.701	0.4	18	4.2	4.2	4.2	4.2	4.2	4.2	-	-	-	-
1.8	185	0.807	0.807	0.492	0.701	0.4	18	4	4	4	4	4	-	-	-	-	-
2.2	225	0.807	0.807	0.492	0.701	0.4	18	4.5	4.5	4.5	4.5	4.5	-	-	-	-	-
2.7	275	0.807	0.807	0.492	0.701	0.4	18	5	5	5	5	5	-	-	-	-	-
3.9	395	0.807	0.807	0.492	0.701	0.4	18	3.1	3.1	3.1	3.1	-	-	-	-	-	-
4.7	475	0.807	0.807	0.492	0.701	0.4	18	3.7	3.7	3.7	3.7	-	-	-	-	-	-
5.6	565	0.807	0.807	0.492	0.701	0.4	18	4.4	4.4	4.4	4.4	-	-	-	-	-	-
8.2	825	0.807	0.807	0.492	0.701	0.4	18	6	6	6	-	-	-	-	-	-	-
10	106	0.807	0.807	0.492	0.701	0.4	18	7.3	7.3	7.3	-	-	-	-	-	-	-
12	126	0.807	0.807	0.492	0.701	0.4	18	6.4	6.4	-	-	-	-	-	-	-	-
15	156	0.807	0.807	0.492	0.701	0.4	18	8	8	-	-	-	-	-	-	-	-
18	186	0.807	0.807	0.492	0.701	0.4	18	7.6	8	-	-	-	-	-	-	-	-
22	226	0.807	0.807	0.492	0.701	0.4	18	8	8	-	-	-	-	-	-	-	-
0.27	274	0.807	0.807	0.788	0.701	0.4	18	1.8	1.8	1.8	1.8	1.8	1.8	1.8	1.8	1.8	1.8
0.33	334	0.807	0.807	0.788	0.701	0.4	18	2.2	2.2	2.2	2.2	2.2	2.2	2.2	2.2	2.2	2.2
0.39	394	0.807	0.807	0.788	0.701	0.4	18	2.6	2.6	2.6	2.6	2.6	2.6	2.6	2.6	2.6	2.6
0.47	474	0.807	0.807	0.788	0.701	0.4	18	2.5	2.5	2.5	2.5	2.5	2.5	2.5	2.5	2.5	-
0.56	564	0.807	0.807	0.788	0.701	0.4	18	2.9	2.9	2.9	2.9	2.9	2.9	2.9	2.9	2.9	-
0.68	684	0.807	0.807	0.788	0.701	0.4	18	3.4	3.4	3.4	3.4	3.4	3.4	3.4	3.4	3.4	-
0.82	824	0.807	0.807	0.788	0.701	0.4	18	3.4	3.4	3.4	3.4	3.4	3.4	3.4	3.4	-	-
1	105	0.807	0.807	0.788	0.701	0.4	18	4.1	4.1	4.1	4.1	4.1	4.1	4.1	4.1	-	-
1.2	125	0.807	0.807	0.788	0.701	0.4	18	3.9	3.9	3.9	3.9	3.9	3.9	3.9	-	-	-
1.5	155	0.807	0.807	0.788	0.701	0.4	18	5	5	5	5	5	5	5	-	-	-
1.8	185	0.807	0.807	0.788	0.701	0.4	18	5	5	5	5	5	5	5.8	-	-	-
2.2	225	0.807	0.807	0.788	0.701	0.4	18	6.3	6.3	6.3	6.3	6.3	6.3	-	-	-	-
2.7	275	0.807	0.807	0.788	0.701	0.4	18	6.3	6.3	6.3	6.3	6.3	6.3	-	-	-	-
3.3	335	0.807	0.807	0.788	0.701	0.4	18	5	5	5	5	5	-	-	-	-	-
3.9	395	0.807	0.807	0.788	0.701	0.4	18	5.9	5.9	5.9	5.9	5.9	-	-	-	-	-
4.7	475	0.807	0.807	0.788	0.701	0.4	18	7.1	7.1	7.1	7.1	7.1	-	-	-	-	-
6.8	685	0.807	0.807	0.788	0.701	0.4	18	5.4	5.4	5.4	5.4	-	-	-	-	-	-
8.2	825	0.807	0.807	0.788	0.701	0.4	18	6.5	6.5	6.5	6.5	-	-	-	-	-	-
10	106	0.807	0.807	0.788	0.701	0.4	18	7.9	7.9	7.9	7.9	-	-	-	-	-	-
12	126	0.807	0.807	0.788	0.701	0.4	18	8	8	8	-	-	-	-	-	-	-
15	156	0.807	0.807	0.788	0.701	0.4	18	10	10	10	-	-	-	-	-	-	-
18	186	0.807	0.807	0.788	0.701	0.4	18	10	10	10	-	-	-	-	-	-	-
27	276	0.807	0.807	0.788	0.701	0.4	18	10	10	-	-	-	-	-	-	-	-
33	336	0.807	0.807	0.788	0.701	0.4	18	10	10	-	-	-	-	-	-	-	-
39	396	0.807	0.807	0.788	0.701	0.4	18	11.8	-	-	-	-	-	-	-	-	-

RMS current rated at 300kHz up to 105°C.

CAPACITORS FOR HIGH FREQUENCY SWITCH MODE POWER SUPPLIES

STANDARD RATINGS

Capacitance		Dimensions (in inches)						TYPE DPM 907									
μF	Code	Max. "L"	Max. "E"	Max. "H"	"X" +/- 0.02	"Y" +/- 0.02	"W" Gauge	63 V (l. rms)	100 V (l. rms)	160 V (l. rms)	250 V (l. rms)	400 V (l. rms)	500 V (l. rms)	630 V (l. rms)	800 V (l. rms)	1,000 V (l. rms)	1,250 V (l. rms)
0.47	474	0.807	0.807	1.181	0.701	0.4	18	3.1	3.1	3.1	3.1	3.1	3.1	3.1	3.1	3.1	3.1
0.56	564	0.807	0.807	1.181	0.701	0.4	18	3.7	3.7	3.7	3.7	3.7	3.7	3.7	3.7	3.7	3.7
0.82	824	0.807	0.807	1.181	0.701	0.4	18	4.3	4.3	4.3	4.3	4.3	4.3	4.3	4.3	4.3	4.3
1	105	0.807	0.807	1.181	0.701	0.4	18	5.2	5.2	5.2	5.2	5.2	5.2	5.2	5.2	5.2	-
1.2	125	0.807	0.807	1.181	0.701	0.4	18	5	5	5	5	5	5	5	5	-	-
1.5	155	0.807	0.807	1.181	0.701	0.4	18	6.2	6.2	6.2	6.2	6.2	6.2	6.2	6.2	-	-
2.2	225	0.807	0.807	1.181	0.701	0.4	18	7.2	7.2	7.2	7.2	7.2	7.2	7.2	-	-	-
2.7	275	0.807	0.807	1.181	0.701	0.4	18	8.8	8.8	8.8	8.8	8.8	8.8	8.8	-	-	-
3.3	335	0.807	0.807	1.181	0.701	0.4	18	6.3	6.3	3.6	6.3	6.3	6.3	10.8	-	-	-
3.9	395	0.807	0.807	1.181	0.701	0.4	18	8	8	8	8	8	8	-	-	-	-
4.7	475	0.807	0.807	1.181	0.701	0.4	18	8	8	8	8	8	8	-	-	-	-
5.6	565	0.807	0.807	1.181	0.701	0.4	18	7.9	7.9	7.9	7.9	7.9	-	-	-	-	-
6.8	685	0.807	0.807	1.181	0.701	0.4	18	9.6	9.6	9.6	9.6	9.6	-	-	-	-	-
8.2	825	0.807	0.807	1.181	0.701	0.4	18	11.5	11.5	11.5	11.5	11.5	-	-	-	-	-
12	126	0.807	0.807	1.181	0.701	0.4	18	9.5	9.5	9.5	9.5	-	-	-	-	-	-
15	156	0.807	0.807	1.181	0.701	0.4	18	11.9	11.9	11.9	11.9	-	-	-	-	-	-
18	186	0.807	0.807	1.181	0.701	0.4	18	12.5	12.5	12.5	12.5	-	-	-	-	-	-
22	226	0.807	0.807	1.181	0.701	0.4	18	10	10	10	-	-	-	-	-	-	-
27	276	0.807	0.807	1.181	0.701	0.4	18	12.5	12.5	12.5	-	-	-	-	-	-	-
33	336	0.807	0.807	1.181	0.701	0.4	18	12.5	12.5	12.5	-	-	-	-	-	-	-
39	396	0.807	0.807	1.181	0.701	0.4	18	12.5	12.5	-	-	-	-	-	-	-	-
47	476	0.807	0.807	1.181	0.701	0.4	18	12.5	12.5	-	-	-	-	-	-	-	-
56	566	0.807	0.807	1.181	0.701	0.4	18	12.5	-	-	-	-	-	-	-	-	-
0.68	684	1.24	1.28	0.866	1.1	0.6	18	2.4	2.4	2.4	2.4	2.4	2.4	2.4	2.4	2.4	2.4
1	105	1.24	1.28	0.866	1.1	0.6	18	3.6	3.6	3.6	3.6	3.6	3.6	3.6	3.6	3.6	3.6
1.2	125	1.24	1.28	0.866	1.1	0.6	18	3.4	3.4	3.4	3.4	3.4	3.4	3.4	3.4	3.4	4.3
1.5	155	1.24	1.28	0.866	1.1	0.6	18	4.3	4.3	4.3	4.3	4.3	4.3	4.3	4.3	4.3	5.4
1.8	185	1.24	1.28	0.866	1.1	0.6	18	4.3	4.3	4.3	4.3	4.3	4.3	4.3	4.3	5.1	-
2.2	225	1.24	1.28	0.866	1.1	0.6	18	5.2	5.2	5.2	5.2	5.2	5.2	5.2	5.2	6.2	-
2.7	275	1.24	1.28	0.866	1.1	0.6	18	6.4	6.4	6.4	6.4	6.4	6.4	6.4	6.4	-	-
3.3	335	1.24	1.28	0.866	1.1	0.6	18	7.8	7.8	7.8	7.8	7.8	7.8	7.8	7.8	-	-
3.9	395	1.24	1.28	0.866	1.1	0.6	18	7	7	7	7	7	7	7	-	-	-
4.7	475	1.24	1.28	0.866	1.1	0.6	18	8.5	8.5	8.5	8.5	8.5	8.5	8.5	-	-	-
5.6	565	1.24	1.28	0.866	1.1	0.6	18	7.9	7.9	7.9	7.9	7.9	7.9	10.1	-	-	-
6.8	685	1.24	1.28	0.866	1.1	0.6	18	9.6	9.6	9.6	9.6	9.6	9.6	-	-	-	-
8.2	825	1.24	1.28	0.866	1.1	0.6	18	11.5	11.5	11.5	11.5	11.5	11.5	-	-	-	-
10	106	1.24	1.28	0.866	1.1	0.6	18	11.2	11.2	11.2	11.2	11.2	14	-	-	-	-
12	126	1.24	1.28	0.866	1.1	0.6	18	13.4	13.4	13.4	13.4	13.4	-	-	-	-	-
15	156	1.24	1.28	0.866	1.1	0.6	18	15	15	15	15	15	-	-	-	-	-
22	226	1.24	1.28	0.866	1.1	0.6	18	9.9	9.9	9.9	9.9	-	-	-	-	-	-
27	276	1.24	1.28	0.866	1.1	0.6	18	12.1	12.1	12.1	12.1	-	-	-	-	-	-
33	336	1.24	1.28	0.866	1.1	0.6	18	14.9	14.9	14.9	14.9	-	-	-	-	-	-
39	396	1.24	1.28	0.866	1.1	0.6	18	15	15	15	-	-	-	-	-	-	-
47	476	1.24	1.28	0.866	1.1	0.6	18	15	15	15	-	-	-	-	-	-	-
56	566	1.24	1.28	0.866	1.1	0.6	18	15	15	15	-	-	-	-	-	-	-
68	686	1.24	1.28	0.866	1.1	0.6	18	15	15	-	-	-	-	-	-	-	-
82	826	1.24	1.28	0.866	1.1	0.6	18	15	15	-	-	-	-	-	-	-	-
100	107	1.24	1.28	0.866	1.1	0.6	18	15	15	-	-	-	-	-	-	-	-
120	127	1.24	1.28	0.866	1.1	0.6	18	15	-	-	-	-	-	-	-	-	-

RMS current rated at 300kHz up to 105°C.

CAPACITORS FOR HIGH FREQUENCY SWITCH MODE POWER SUPPLIES

TYPE DPM 907

STANDARD RATINGS

Capacitance		Dimensions (in inches)						TYPE DPM 907									
μF	Code	Max. "L"	Max. "E"	Max. "H"	"X" +/- 0.02	"Y" +/- 0.02	"W" Gauge	63 V (l. rms)	100 V (l. rms)	160 V (l. rms)	250 V (l. rms)	400 V (l. rms)	500 V (l. rms)	630 V (l. rms)	800 V (l. rms)	1,000 V (l. rms)	1,250 V (l. rms)
1.8	185	1.24	1.28	1.26	1.1	0.6	18	6.5	6.5	6.5	6.5	6.5	6.5	6.5	6.5	6.5	6.5
2.2	225	1.24	1.28	1.26	1.1	0.6	18	7.9	7.9	7.9	7.9	7.9	7.9	7.9	7.9	7.9	7.9
2.7	275	1.24	1.28	1.26	1.1	0.6	18	7.7	7.7	7.7	7.7	7.7	7.7	7.7	7.7	7.7	-
3.3	335	1.24	1.28	1.26	1.1	0.6	18	9.4	9.4	9.4	9.4	9.4	9.4	9.4	9.4	9.4	-
3.9	395	1.24	1.28	1.26	1.1	0.6	18	9.2	9.2	9.2	9.2	9.2	9.2	9.2	9.2	11	-
4.7	475	1.24	1.28	1.26	1.1	0.6	18	11	11	11	11	11	11	11	11	-	-
5.6	565	1.24	1.28	1.26	1.1	0.6	18	12.5	12.5	12.5	12.5	12.5	12.5	12.5	12.5	-	-
6.8	685	1.24	1.28	1.26	1.1	0.6	18	12.3	12.3	12.3	12.3	12.3	12.3	12.3	-	-	-
8.2	825	1.24	1.28	1.26	1.1	0.6	18	14.7	14.7	14.7	14.7	14.7	14.7	14.7	-	-	-
10	106	1.24	1.28	1.26	1.1	0.6	18	15	15	15	15	15	15	15	-	-	-
12	126	1.24	1.28	1.26	1.1	0.6	18	15	15	15	15	15	15	-	-	-	-
15	156	1.24	1.28	1.26	1.1	0.6	18	15	15	15	15	15	15	-	-	-	-
18	186	1.24	1.28	1.26	1.1	0.6	18	15	15	15	15	15	-	-	-	-	-
22	226	1.24	1.28	1.26	1.1	0.6	18	15	15	15	15	15	-	-	-	-	-
39	396	1.24	1.28	1.26	1.1	0.6	18	15	15	15	15	-	-	-	-	-	-
47	476	1.24	1.28	1.26	1.1	0.6	18	15	15	15	15	-	-	-	-	-	-
56	566	1.24	1.28	1.26	1.1	0.6	18	15	15	15	15	-	-	-	-	-	-
68	686	1.24	1.28	1.26	1.1	0.6	18	15	15	15	-	-	-	-	-	-	-
82	826	1.24	1.28	1.26	1.1	0.6	18	15	15	15	-	-	-	-	-	-	-
100	107	1.24	1.28	1.26	1.1	0.6	18	15	15	15	-	-	-	-	-	-	-
120	127	1.24	1.28	1.26	1.1	0.6	18	15	15	-	-	-	-	-	-	-	-
150	157	1.24	1.28	1.26	1.1	0.6	18	150	15	-	-	-	-	-	-	-	-
180	187	1.24	1.28	1.26	1.1	0.6	18	150	-	-	-	-	-	-	-	-	-

RMS current rated at 300kHz up to 105°C.

CAPACITORS FOR HIGH FREQUENCY SWITCH MODE POWER SUPPLIES



DIMENSIONS (in inches)

TYPE DPM 907 R1

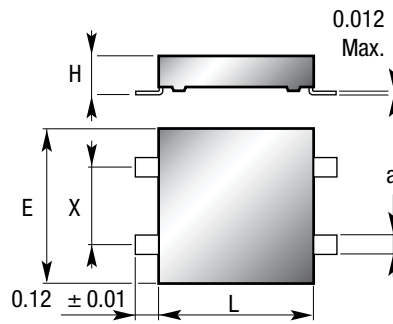

TYPE DPM 907 R2

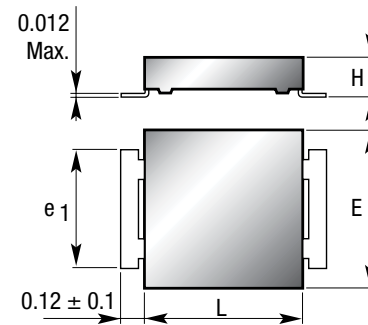

PHYSICAL CHARACTERISTICS

CONSTRUCTION:

Dielectric: Metalized polyethylene terephthalate. Self healing, low inductance.

CASE:

Thermoplastic case. Epoxy resin molded.

LEAD MATERIAL:

DPM 907 R1 & R2 - Termination are surface mount "SMD".

MARKING:

Dearborn trademark, type or catalog number, capacitance, tolerance and voltage.

ELECTRICAL SPECIFICATIONS

OPERATING TEMPERATURE RANGE:

-55°C to +125°C

DISSIPATION FACTOR:

Maximum 1% @ 1kHz

INSULATION RESISTANCE:

$\geq 7,500 \text{ M}\Omega$ for $C_R \leq 0.33 \mu\text{F}$

$\geq 2,500 \text{ M}\Omega \cdot \mu\text{F}$ for $C_R > 0.33 \mu\text{F}$

DIELECTRIC WITHSTANDING VOLTAGE (DWW):

1.6 x rated voltage

INSULATION BETWEEN LEADS & CASE:

50,000 $\text{M}\Omega$

PERMISSIBLE CURRENT:

@ 300kHz up to 105°C = I_{rms}

@ 300kHz at 125°C = $0.1 I_{\text{rms}}$

AVAILABLE CAPACITANCE TOLERANCES:

$\pm 20\%$ & $\pm 10\%$

CAPACITORS FOR HIGH FREQUENCY SWITCH MODE POWER SUPPLIES

TYPE DPM 907
R1/R2

STANDARD RATINGS

Capacitance		Dimensions (in inches)						TYPE DPM 907 R1 / R2									
μF	Code	Max. "L"	Max. "E"	Max. "H"	"X" +/- 0.02	"e ₁ " +/- 0.02	"a" +/- 0.002	63 V (l. rms)	100 V (l. rms)	160 V (l. rms)	250 V (l. rms)	400 V (l. rms)	500 V (l. rms)	630 V (l. rms)	800 V (l. rms)	1,000 V (l. rms)	1,250 V (l. rms)
0.22	224	0.807	0.807	0.256	0.394	0.591	0.1	0.8	0.8	0.8	0.8	0.8	0.8	0.8	0.9	-	-
0.27	274	0.807	0.807	0.256	0.394	0.591	0.1	0.9	0.9	0.9	0.9	0.9	0.9	0.9	-	-	-
0.33	334	0.807	0.807	0.256	0.394	0.591	0.1	1.1	1.1	1.1	1.1	1.1	1.1	1.1	-	-	-
0.39	394	0.807	0.807	0.256	0.394	0.591	0.1	1.1	1.1	1.1	1.1	1.1	1.1	1.3	-	-	-
0.47	474	0.807	0.807	0.256	0.394	0.591	0.1	1.3	1.3	1.3	1.3	1.3	1.3	-	-	-	-
0.56	564	0.807	0.807	0.256	0.394	0.591	0.1	1.5	1.5	1.5	1.5	1.5	1.5	-	-	-	-
0.68	684	0.807	0.807	0.256	0.394	0.591	0.1	1.9	1.9	1.9	1.9	1.9	1.9	-	-	-	-
0.82	824	0.807	0.807	0.256	0.394	0.591	0.1	2.5	2.5	2.5	2.5	2.5	-	-	-	-	-
1	105	0.807	0.807	0.256	0.394	0.591	0.1	3.1	3.1	3.1	3.1	3.1	-	-	-	-	-
1.5	155	0.807	0.807	0.256	0.394	0.591	0.1	1.5	1.5	1.5	1.5	-	-	-	-	-	-
2.2	225	0.807	0.807	0.256	0.394	0.591	0.1	2.2	2.2	2.2	2.2	-	-	-	-	-	-
2.7	275	0.807	0.807	0.256	0.394	0.591	0.1	2.4	2.4	2.4	2.4	-	-	-	-	-	-
3.3	335	0.807	0.807	0.256	0.394	0.591	0.1	2	2	2	-	-	-	-	-	-	-
3.9	395	0.807	0.807	0.256	0.394	0.591	0.1	2.5	2.5	2.5	-	-	-	-	-	-	-
4.7	475	0.807	0.807	0.256	0.394	0.591	0.1	2.5	2.5	3.1	-	-	-	-	-	-	-
5.6	565	0.807	0.807	0.256	0.394	0.591	0.1	3.2	3.2	-	-	-	-	-	-	-	-
6.8	685	0.807	0.807	0.256	0.394	0.591	0.1	4.3	4.3	-	-	-	-	-	-	-	-
8.2	825	0.807	0.807	0.256	0.394	0.591	0.1	3.2	5.2	-	-	-	-	-	-	-	-
10	106	0.807	0.807	0.256	0.394	0.591	0.1	4	-	-	-	-	-	-	-	-	-
12	126	0.807	0.807	0.256	0.394	0.591	0.1	5	-	-	-	-	-	-	-	-	-
0.082	823	0.807	0.807	0.315	0.394	0.591	0.1	0.5	0.5	0.5	0.5	0.5	0.5	0.5	0.5	0.5	0.5
0.1	104	0.807	0.807	0.315	0.394	0.591	0.1	0.7	0.7	0.7	0.7	0.7	0.7	0.7	0.7	0.7	0.7
0.15	154	0.807	0.807	0.315	0.394	0.591	0.1	0.8	0.8	0.8	0.8	0.8	0.8	0.8	0.8	0.8	-
0.22	224	0.807	0.807	0.315	0.394	0.591	0.1	1.1	1.1	1.1	1.1	1.1	1.1	1.1	1.1	1.1	-
0.27	274	0.807	0.807	0.315	0.394	0.591	0.1	1.1	1.1	1.1	1.1	1.1	1.1	1.1	1.1	-	-
0.33	334	0.807	0.807	0.315	0.394	0.591	0.1	1.4	1.4	1.4	1.4	1.4	1.4	1.4	1.4	-	-
0.47	474	0.807	0.807	0.315	0.394	0.591	0.1	1.6	1.6	1.6	1.6	1.6	1.6	1.6	-	-	-
0.56	564	0.807	0.807	0.315	0.394	0.591	0.1	2	2	2	2	2	2	2	-	-	-
0.82	824	0.807	0.807	0.315	0.394	0.591	0.1	2.3	2.3	2.3	2.3	2.3	2.3	-	-	-	-
1	105	0.807	0.807	0.315	0.394	0.591	0.1	2.8	2.8	2.8	2.8	2.8	2.8	-	-	-	-
1.2	125	0.807	0.807	0.315	0.394	0.591	0.1	3.2	3.2	3.2	3.2	3.2	-	-	-	-	-
1.5	155	0.807	0.807	0.315	0.394	0.591	0.1	4	4	4	4	4	-	-	-	-	-
3.3	335	0.807	0.807	0.315	0.394	0.591	0.1	2.6	2.6	2.6	2.6	-	-	-	-	-	-
5.6	565	0.807	0.807	0.315	0.394	0.591	0.1	4	4	4	-	-	-	-	-	-	-
6.8	685	0.807	0.807	0.315	0.394	0.591	0.1	5	5	5	-	-	-	-	-	-	-
10	106	0.807	0.807	0.315	0.394	0.591	0.1	6.4	6.4	-	-	-	-	-	-	-	-
15	156	0.807	0.807	0.315	0.394	0.591	0.1	6.3	-	-	-	-	-	-	-	-	-

RMS current rated at 300kHz up to 105°C.

CAPACITORS FOR HIGH FREQUENCY SWITCH MODE POWER SUPPLIES

STANDARD RATINGS

Capacitance		Dimensions (in inches)						TYPE DPM 907 R1 / R2									
µF	Code	Max. "L"	Max. "E"	Max. "H"	"X" +/- 0.02	"e," +/- 0.02	"a" +/- 0.002	63 V (l. rms)	100 V (l. rms)	160 V (l. rms)	250 V (l. rms)	400 V (l. rms)	500 V (l. rms)	630 V (l. rms)	800 V (l. rms)	1,000 V (l. rms)	1,250 V (l. rms)
0.12	124	0.807	0.807	0.492	0.394	0.591	0.1	0.8	0.8	0.8	0.8	0.8	0.8	0.8	0.8	0.8	0.8
0.15	154	0.807	0.807	0.492	0.394	0.591	0.1	1	1	1	1	1	1	1	1	1	1
0.18	184	0.807	0.807	0.492	0.394	0.591	0.1	1.2	1.2	1.2	1.2	1.2	1.2	1.2	1.2	1.2	1.2
0.22	224	0.807	0.807	0.492	0.394	0.591	0.1	1.5	1.5	1.5	1.5	1.5	1.5	1.5	1.5	1.5	1.5
0.27	274	0.807	0.807	0.492	0.394	0.591	0.1	1.4	1.4	1.4	1.4	1.4	1.4	1.4	1.4	1.4	-
0.33	334	0.807	0.807	0.492	0.394	0.591	0.1	1.7	1.7	1.7	1.7	1.7	1.7	1.7	1.7	1.7	-
0.39	394	0.807	0.807	0.492	0.394	0.591	0.1	1.6	1.6	1.6	1.6	1.6	1.6	1.6	1.6	2	-
0.47	474	0.807	0.807	0.492	0.394	0.591	0.1	1.9	1.9	1.9	1.9	1.9	1.9	1.9	1.9	-	-
0.56	564	0.807	0.807	0.492	0.394	0.591	0.1	2.3	2.3	2.3	2.3	2.3	2.3	2.3	2.3	-	-
0.68	684	0.807	0.807	0.492	0.394	0.591	0.1	2.5	2.5	2.5	2.5	2.5	2.5	2.5	2.8	-	-
0.82	824	0.807	0.807	0.492	0.394	0.591	0.1	3	3	3	3	3	3	3	-	-	-
1	105	0.807	0.807	0.492	0.394	0.591	0.1	3.2	3.2	3.2	3.2	3.2	3.2	3.2	-	-	-
1.2	125	0.807	0.807	0.492	0.394	0.591	0.1	3.3	3.3	3.3	3.3	3.3	3.3	-	-	-	-
1.5	155	0.807	0.807	0.492	0.394	0.591	0.1	4.2	4.2	4.2	4.2	4.2	4.2	-	-	-	-
1.8	185	0.807	0.807	0.492	0.394	0.591	0.1	4	4	4	4	4	-	-	-	-	-
2.2	225	0.807	0.807	0.492	0.394	0.591	0.1	4.5	4.5	4.5	4.5	4.5	-	-	-	-	-
2.7	275	0.807	0.807	0.492	0.394	0.591	0.1	5	5	5	5	5	-	-	-	-	-
3.9	395	0.807	0.807	0.492	0.394	0.591	0.1	3.1	3.1	3.1	3.1	-	-	-	-	-	-
4.7	475	0.807	0.807	0.492	0.394	0.591	0.1	3.7	3.7	3.7	3.7	-	-	-	-	-	-
5.6	565	0.807	0.807	0.492	0.394	0.591	0.1	4.4	4.4	4.4	4.4	-	-	-	-	-	-
8.2	825	0.807	0.807	0.492	0.394	0.591	0.1	6	6	6	-	-	-	-	-	-	-
10	106	0.807	0.807	0.492	0.394	0.591	0.1	7.3	7.3	7.3	-	-	-	-	-	-	-
12	126	0.807	0.807	0.492	0.394	0.591	0.1	6.4	6.4	-	-	-	-	-	-	-	-
15	156	0.807	0.807	0.492	0.394	0.591	0.1	8	8	-	-	-	-	-	-	-	-
18	186	0.807	0.807	0.492	0.394	0.591	0.1	7.6	8	-	-	-	-	-	-	-	-
22	226	0.807	0.807	0.492	0.394	0.591	0.1	8	8	-	-	-	-	-	-	-	-
0.27	274	0.807	0.807	0.788	0.394	0.591	0.1	1.8	1.8	1.8	1.8	1.8	1.8	1.8	1.8	1.8	1.8
0.33	334	0.807	0.807	0.788	0.394	0.591	0.1	2.2	2.2	2.2	2.2	2.2	2.2	2.2	2.2	2.2	2.2
0.39	394	0.807	0.807	0.788	0.394	0.591	0.1	2.6	2.6	2.6	2.6	2.6	2.6	2.6	2.6	2.6	2.6
0.47	474	0.807	0.807	0.788	0.394	0.591	0.1	2.5	2.5	2.5	2.5	2.5	2.5	2.5	2.5	2.5	-
0.56	564	0.807	0.807	0.788	0.394	0.591	0.1	2.9	2.9	2.9	2.9	2.9	2.9	2.9	2.9	2.9	-
0.68	684	0.807	0.807	0.788	0.394	0.591	0.1	3.4	3.4	3.4	3.4	3.4	3.4	3.4	3.4	3.4	-
0.82	824	0.807	0.807	0.788	0.394	0.591	0.1	3.4	3.4	3.4	3.4	3.4	3.4	3.4	3.4	-	-
1	105	0.807	0.807	0.788	0.394	0.591	0.1	4.1	4.1	4.1	4.1	4.1	4.1	4.1	4.1	-	-
1.2	125	0.807	0.807	0.788	0.394	0.591	0.1	3.9	3.9	3.9	3.9	3.9	3.9	3.9	-	-	-
1.5	155	0.807	0.807	0.788	0.394	0.591	0.1	5	5	5	5	5	5	5	-	-	-
1.8	185	0.807	0.807	0.788	0.394	0.591	0.1	5	5	5	5	5	5	5.8	-	-	-
2.2	225	0.807	0.807	0.788	0.394	0.591	0.1	6.3	6.3	6.3	6.3	6.3	6.3	-	-	-	-
2.7	275	0.807	0.807	0.788	0.394	0.591	0.1	6.3	6.3	6.3	6.3	6.3	6.3	-	-	-	-
3.3	335	0.807	0.807	0.788	0.394	0.591	0.1	5	5	5	5	5	-	-	-	-	-
3.9	395	0.807	0.807	0.788	0.394	0.591	0.1	5.9	5.9	5.9	5.9	5.9	-	-	-	-	-
4.7	475	0.807	0.807	0.788	0.394	0.591	0.1	7.1	7.1	7.1	7.1	7.1	-	-	-	-	-
6.8	685	0.807	0.807	0.788	0.394	0.591	0.1	5.4	5.4	5.4	5.4	-	-	-	-	-	-
8.2	825	0.807	0.807	0.788	0.394	0.591	0.1	6.5	6.5	6.5	6.5	-	-	-	-	-	-
10	106	0.807	0.807	0.788	0.394	0.591	0.1	7.9	7.9	7.9	7.9	-	-	-	-	-	-
12	126	0.807	0.807	0.788	0.394	0.591	0.1	8	8	8	-	-	-	-	-	-	-
15	156	0.807	0.807	0.788	0.394	0.591	0.1	10	10	10	-	-	-	-	-	-	-
18	186	0.807	0.807	0.788	0.394	0.591	0.1	10	10	10	-	-	-	-	-	-	-
27	276	0.807	0.807	0.788	0.394	0.591	0.1	10	10	-	-	-	-	-	-	-	-
33	336	0.807	0.807	0.788	0.394	0.591	0.1	33	10	-	-	-	-	-	-	-	-
39	396	0.807	0.807	0.788	0.394	0.591	0.1	11.8	-	-	-	-	-	-	-	-	-

RMS current rated at 300kHz up to 105°C.

CAPACITORS FOR HIGH FREQUENCY SWITCH MODE POWER SUPPLIES

TYPE DPM 907
R1/R2

STANDARD RATINGS

Capacitance		Dimensions (in inches)						TYPE DPM 907 R1 / R2									
μF	Code	Max. "L"	Max. "E"	Max. "H"	"X" +/- 0.02	"e ₁ " +/- 0.02	"a" +/- 0.002	63 V (l. rms)	100 V (l. rms)	160 V (l. rms)	250 V (l. rms)	400 V (l. rms)	500 V (l. rms)	630 V (l. rms)	800 V (l. rms)	1,000 V (l. rms)	1,250 V (l. rms)
0.47	474	0.807	0.807	1.181	0.394	0.591	0.1	3.1	3.1	3.1	3.1	3.1	3.1	3.1	3.1	3.1	3.1
0.56	564	0.807	0.807	1.181	0.394	0.591	0.1	3.7	3.7	3.7	3.7	3.7	3.7	3.7	3.7	3.7	3.7
0.82	824	0.807	0.807	1.181	0.394	0.591	0.1	4.3	4.3	4.3	4.3	4.3	4.3	4.3	4.3	4.3	-
1	105	0.807	0.807	1.181	0.394	0.591	0.1	5.2	5.2	5.2	5.2	5.2	5.2	5.2	5.2	5.2	-
1.2	125	0.807	0.807	1.181	0.394	0.591	0.1	5	5	5	5	5	5	5	5	-	-
1.5	155	0.807	0.807	1.181	0.394	0.591	0.1	6.2	6.2	6.2	6.2	6.2	6.2	6.2	6.2	-	-
2.2	225	0.807	0.807	1.181	0.394	0.591	0.1	7.2	7.2	7.2	7.2	7.2	7.2	7.2	-	-	-
2.7	275	0.807	0.807	1.181	0.394	0.591	0.1	8.8	8.8	8.8	8.8	8.8	8.8	8.8	-	-	-
3.3	335	0.807	0.807	1.181	0.394	0.591	0.1	6.3	6.3	6.3	6.3	6.3	6.3	10.8	-	-	-
3.9	395	0.807	0.807	1.181	0.394	0.591	0.1	8	8	8	8	8	8	-	-	-	-
4.7	455	0.807	0.807	1.181	0.394	0.591	0.1	8	8	8	8	8	8	-	-	-	-
5.6	565	0.807	0.807	1.181	0.394	0.591	0.1	7.9	7.9	7.9	7.9	7.9	-	-	-	-	-
6.8	685	0.807	0.807	1.181	0.394	0.591	0.1	9.6	9.6	9.6	9.6	9.6	-	-	-	-	-
8.2	825	0.807	0.807	1.181	0.394	0.591	0.1	11.5	11.5	11.5	11.5	11.5	-	-	-	-	-
12	126	0.807	0.807	1.181	0.394	0.591	0.1	9.5	9.5	9.5	9.5	-	-	-	-	-	-
15	156	0.807	0.807	1.181	0.394	0.591	0.1	11.9	11.9	11.9	11.9	-	-	-	-	-	-
18	186	0.807	0.807	1.181	0.394	0.591	0.1	12.5	12.5	12.5	12.5	-	-	-	-	-	-
22	226	0.807	0.807	1.181	0.394	0.591	0.1	10	10	10	-	-	-	-	-	-	-
27	276	0.807	0.807	1.181	0.394	0.591	0.1	12.5	12.5	12.5	-	-	-	-	-	-	-
33	336	0.807	0.807	1.181	0.394	0.591	0.1	12.5	12.5	12.5	-	-	-	-	-	-	-
39	396	0.807	0.807	1.181	0.394	0.591	0.1	12.5	12.5	-	-	-	-	-	-	-	-
47	476	0.807	0.807	1.181	0.394	0.591	0.1	12.5	12.5	-	-	-	-	-	-	-	-
56	566	0.807	0.807	1.181	0.394	0.591	0.1	12.5	-	-	-	-	-	-	-	-	-
0.68	684	1.24	1.28	0.866	0.945	0.945	0.158	2.4	2.4	2.4	2.4	2.4	2.4	2.4	2.4	2.4	2.4
1	105	1.24	1.28	0.866	0.945	0.945	0.158	3.6	3.6	3.6	3.6	3.6	3.6	3.6	3.6	3.6	3.6
1.2	12	1.24	1.28	0.866	0.945	0.945	0.158	3.4	3.4	3.4	3.4	3.4	3.4	3.4	3.4	3.4	4.3
1.5	155	1.24	1.28	0.866	0.945	0.945	0.158	4.3	4.3	4.3	4.3	4.3	4.3	4.3	4.3	4.3	5.4
1.8	185	1.24	1.28	0.866	0.945	0.945	0.158	4.3	4.3	4.3	4.3	4.3	4.3	4.3	4.3	5.1	-
2.2	225	1.24	1.28	0.866	0.945	0.945	0.158	5.2	5.2	5.2	5.2	5.2	5.2	5.2	5.2	2.2	-
2.7	275	1.24	1.28	0.866	0.945	0.945	0.158	6.4	6.4	6.4	6.4	6.4	6.4	6.4	6.4	-	-
3.3	335	1.24	1.28	0.866	0.945	0.945	0.158	7.8	7.8	7.8	7.8	7.8	7.8	7.8	7.8	-	-
3.9	395	1.24	1.28	0.866	0.945	0.945	0.158	7	7	7	7	7	7	7	-	-	-
4.7	475	1.24	1.28	0.866	0.945	0.945	0.158	8.5	8.5	8.5	8.5	8.5	8.5	8.5	-	-	-
5.6	565	1.24	1.28	0.866	0.945	0.945	0.158	7.9	7.9	7.9	7.9	7.9	7.9	10.1	-	-	-
6.8	685	1.24	1.28	0.866	0.945	0.945	0.158	9.6	9.6	9.6	9.6	9.6	9.6	-	-	-	-
8.2	825	1.24	1.28	0.866	0.945	0.945	0.158	11.5	11.5	11.5	11.5	11.5	11.5	-	-	-	-
10	106	1.24	1.28	0.866	0.945	0.945	0.158	11.2	11.2	11.2	11.2	11.2	14	-	-	-	-
12	126	1.24	1.28	0.866	0.945	0.945	0.158	13.4	13.4	13.4	13.4	13.4	-	-	-	-	-
15	156	1.24	1.28	0.866	0.945	0.945	0.158	15	15	15	15	15	-	-	-	-	-
22	226	1.24	1.28	0.866	0.945	0.945	0.158	9.9	9.9	9.9	9.9	-	-	-	-	-	-
27	276	1.24	1.28	0.866	0.945	0.945	0.158	12.1	12.1	12.1	12.1	-	-	-	-	-	-
33	336	1.24	1.28	0.866	0.945	0.945	0.158	14.9	14.9	14.9	14.9	-	-	-	-	-	-
39	396	1.24	1.28	0.866	0.945	0.945	0.158	15	15	15	-	-	-	-	-	-	-
47	476	1.24	1.28	0.866	0.945	0.945	0.158	15	15	15	-	-	-	-	-	-	-
56	566	1.24	1.28	0.866	0.945	0.945	0.158	15	15	15	-	-	-	-	-	-	-
68	686	1.24	1.28	0.866	0.945	0.945	0.158	15	15	-	-	-	-	-	-	-	-
82	826	1.24	1.28	0.866	0.945	0.945	0.158	15	15	-	-	-	-	-	-	-	-
100	107	1.24	1.28	0.866	0.945	0.945	0.158	15	15	-	-	-	-	-	-	-	-
120	127	1.24	1.28	0.866	0.945	0.945	0.158	15	-	-	-	-	-	-	-	-	-

RMS current rated at 300kHz up to 105°C.

CAPACITORS FOR HIGH FREQUENCY SWITCH MODE POWER SUPPLIES

STANDARD RATINGS

Capacitance		Dimensions (in inches)						TYPE DPM 907 R1 / R2									
µF	Code	Max. "L"	Max. "E"	Max. "H"	"X" +/- 0.02	"e." +/- 0.02	"a" +/- 0.002	63 V (l. rms)	100 V (l. rms)	160 V (l. rms)	250 V (l. rms)	400 V (l. rms)	500 V (l. rms)	630 V (l. rms)	800 V (l. rms)	1,000 V (l. rms)	1,250 V (l. rms)
1.8	185	1.24	1.28	1.26	0.945	0.945	0.158	6.5	6.5	6.5	6.5	6.5	6.5	6.5	6.5	6.5	6.5
2.2	225	1.24	1.28	1.26	0.945	0.945	0.158	7.9	7.9	7.9	7.9	7.9	7.9	7.9	7.9	7.9	7.9
2.7	275	1.24	1.28	1.26	0.945	0.945	0.158	7.7	7.7	7.7	7.7	7.7	7.7	7.7	7.7	7.7	-
3.3	335	1.24	1.28	1.26	0.945	0.945	0.158	9.4	9.4	9.4	9.4	9.4	9.4	9.4	9.4	9.4	-
3.9	395	1.24	1.28	1.26	0.945	0.945	0.158	7.7	7.7	7.7	7.7	7.7	7.7	7.7	7.7	11	-
4.7	475	1.24	1.28	1.26	0.945	0.945	0.158	9.4	9.4	9.4	9.4	9.4	9.4	9.4	9.4	-	-
5.6	565	1.24	1.28	1.26	0.945	0.945	0.158	12.5	12.5	12.5	12.5	12.5	12.5	12.5	12.5	-	-
6.8	685	1.24	1.28	1.26	0.945	0.945	0.158	12.3	12.3	12.3	12.3	12.3	12.3	12.3	-	-	-
8.2	825	1.24	1.28	1.26	0.945	0.945	0.158	14.7	14.7	14.7	14.7	14.7	14.7	14.7	-	-	-
10	106	1.24	1.28	1.26	0.945	0.945	0.158	15	15	15	15	15	15	15	-	-	-
12	126	1.24	1.28	1.26	0.945	0.945	0.158	15	15	15	15	15	15	-	-	-	-
15	156	1.24	1.28	1.26	0.945	0.945	0.158	15	15	15	15	15	15	-	-	-	-
18	186	1.24	1.28	1.26	0.945	0.945	0.158	15	15	15	15	15	-	-	-	-	-
22	226	1.24	1.28	1.26	0.945	0.945	0.158	15	15	15	15	15	-	-	-	-	-
39	396	1.24	1.28	1.26	0.945	0.945	0.158	15	15	15	15	-	-	-	-	-	-
47	476	1.24	1.28	1.26	0.945	0.945	0.158	15	15	15	15	-	-	-	-	-	-
56	566	1.24	1.28	1.26	0.945	0.945	0.158	15	15	15	15	-	-	-	-	-	-
68	686	1.24	1.28	1.26	0.945	0.945	0.158	15	15	15	-	-	-	-	-	-	-
82	826	1.24	1.28	1.26	0.945	0.945	0.158	15	15	15	-	-	-	-	-	-	-
100	107	1.24	1.28	1.26	0.945	0.945	0.158	15	15	15	-	-	-	-	-	-	-
120	127	1.24	1.28	1.26	0.945	0.945	0.158	15	15	-	-	-	-	-	-	-	-
150	157	1.24	1.28	1.26	0.945	0.945	0.158	15	15	-	-	-	-	-	-	-	-
180	187	1.24	1.28	1.26	0.945	0.945	0.158	15	-	-	-	-	-	-	-	-	-

RMS current rated at 300kHz up to 105°C.

CAPACITORS FOR HIGH FREQUENCY SWITCH MODE POWER SUPPLIES

TYPE DPM 907 N



PHYSICAL CHARACTERISTICS

CONSTRUCTION:

Dielectric: Metalized polyethylene terephthalate. Self healing, low inductance.

CASE:

Thermoplastic case. Epoxy resin molded.

LEAD MATERIAL:

DPM 907 N - Termination are "DIL leads".

MARKING:

Dearborn trademark, type or catalog number, capacitance, tolerance and voltage.

ELECTRICAL SPECIFICATIONS

OPERATING TEMPERATURE RANGE:

-55°C to +125°C

DISSIPATION FACTOR:

Maximum 1% @ 1kHz

INSULATION RESISTANCE:

$\geq 7,500 \text{ M}\Omega$ for $C_n \leq 0.33 \mu\text{F}$

$\geq 2,500 \text{ M}\Omega \cdot \mu\text{F}$ for $C_n > 0.33 \mu\text{F}$

DIELECTRIC WITHSTANDING VOLTAGE (DWV):

1.6 x rated voltage

INSULATION BETWEEN LEADS & CASE:

50,000 $\text{M}\Omega$

PERMISSIBLE CURRENT:

@ 300kHz up to 105°C = I_{rms}

@ 300kHz at 125°C = $0.1 I_{\text{rms}}$

AVAILABLE CAPACITANCE TOLERANCES:

$\pm 20\%$ & $\pm 10\%$

DIMENSIONS (in inches)

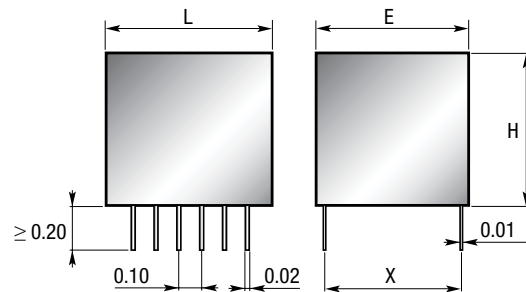

CAPACITORS FOR HIGH FREQUENCY SWITCH MODE POWER SUPPLIES

STANDARD RATINGS

							TYPE DPM 907 N										
Capacitance		Dimensions (in inches)					Nb con± 0.5% / +10% -0.05	63 V (l. rms)	100 V (l. rms)	160 V (l. rms)	250 V (l. rms)	400 V (l. rms)	500 V (l. rms)	630 V (l. rms)	800 V (l. rms)	1,000 V (l. rms)	1,250 V (l. rms)
µF	Code	Max. "L"	Max. "E"	Max. "H"	"X" + /- 0.02												
0.22	224	0.807	0.807	0.256	0.701	0.28 x 0.08	0.8	0.8	0.8	0.8	0.8	0.8	0.8	0.9	-	-	
0.27	274	0.807	0.807	0.256	0.701	0.28 x 0.08	0.9	0.9	0.9	0.9	0.9	0.9	0.9	-	-	-	
0.33	334	0.807	0.807	0.256	0.701	0.28 x 0.08	1.1	1.1	1.1	1.1	1.1	1.1	1.1	-	-	-	
0.39	394	0.807	0.807	0.256	0.701	0.28 x 0.08	1.1	1.1	1.1	1.1	1.1	1.1	1.3	-	-	-	
0.47	474	0.807	0.807	0.256	0.701	0.28 x 0.08	1.3	1.3	1.3	1.3	1.3	1.3	-	-	-	-	
0.56	564	0.807	0.807	0.256	0.701	0.28 x 0.08	1.5	1.5	1.5	1.5	1.5	1.5	-	-	-	-	
0.68	684	0.807	0.807	0.256	0.701	0.28 x 0.08	1.9	1.9	1.9	1.9	1.9	1.9	-	-	-	-	
0.82	824	0.807	0.807	0.256	0.701	0.28 x 0.08	2.5	2.5	2.5	2.5	2.5	-	-	-	-	-	
1	105	0.807	0.807	0.256	0.701	0.28 x 0.08	3.1	3.1	3.1	3.1	3.1	-	-	-	-	-	
1.5	155	0.807	0.807	0.256	0.701	0.28 x 0.08	1.5	1.5	1.5	1.5	-	-	-	-	-	-	
2.2	225	0.807	0.807	0.256	0.701	0.28 x 0.08	2.2	2.2	2.2	2.2	-	-	-	-	-	-	
2.7	275	0.807	0.807	0.256	0.701	0.28 x 0.08	2.4	2.4	2.4	2.4	-	-	-	-	-	-	
3.3	335	0.807	0.807	0.256	0.701	0.28 x 0.08	2	2	2	-	-	-	-	-	-	-	
3.9	395	0.807	0.807	0.256	0.701	0.28 x 0.08	2.5	2.5	2.5	-	-	-	-	-	-	-	
4.7	475	0.807	0.807	0.256	0.701	0.28 x 0.08	2.5	2.5	3.1	-	-	-	-	-	-	-	
5.6	565	0.807	0.807	0.256	0.701	0.28 x 0.08	3.2	3.2	-	-	-	-	-	-	-	-	
6.8	685	0.807	0.807	0.256	0.701	0.28 x 0.08	4.3	4.3	-	-	-	-	-	-	-	-	
8.2	825	0.807	0.807	0.256	0.701	0.28 x 0.08	3.2	5.2	-	-	-	-	-	-	-	-	
10	106	0.807	0.807	0.256	0.701	0.28 x 0.08	4	-	-	-	-	-	-	-	-	-	
12	126	0.807	0.807	0.256	0.701	0.28 x 0.08	5	-	-	-	-	-	-	-	-	-	
0.082	823	0.807	0.807	0.315	0.701	0.28 x 0.08	0.5	0.5	0.5	0.5	0.5	0.5	0.5	0.5	0.5	0.5	
0.1	104	0.807	0.807	0.315	0.701	0.28 x 0.08	0.7	0.7	0.7	0.7	0.7	0.7	0.7	0.7	0.7	0.7	
0.15	154	0.807	0.807	0.315	0.701	0.28 x 0.08	0.8	0.8	0.8	0.8	0.8	0.8	0.8	0.8	0.8	-	
0.22	224	0.807	0.807	0.315	0.701	0.28 x 0.08	1.1	1.1	1.1	1.1	1.1	1.1	1.1	1.1	1.1	-	
0.27	274	0.807	0.807	0.315	0.701	0.28 x 0.08	1.1	1.1	1.1	1.1	1.1	1.1	1.1	1.1	-	-	
0.33	334	0.807	0.807	0.315	0.701	0.28 x 0.08	1.4	1.4	1.4	1.4	1.4	1.4	1.4	1.4	-	-	
0.47	474	0.807	0.807	0.315	0.701	0.28 x 0.08	1.6	1.6	1.6	1.6	1.6	1.6	1.6	-	-	-	
0.56	564	0.807	0.807	0.315	0.701	0.28 x 0.08	2	2	2	2	2	2	2	-	-	-	
0.82	824	0.807	0.807	0.315	0.701	0.28 x 0.08	2.3	2.3	2.3	2.3	2.3	2.3	-	-	-	-	
1	105	0.807	0.807	0.315	0.701	0.28 x 0.08	2.8	2.8	2.8	2.8	2.8	2.8	-	-	-	-	
1.2	125	0.807	0.807	0.315	0.701	0.28 x 0.08	3.2	3.2	3.2	3.2	3.2	-	-	-	-	-	
1.5	155	0.807	0.807	0.315	0.701	0.28 x 0.08	4	4	4	4	4	-	-	-	-	-	
3.3	335	0.807	0.807	0.315	0.701	0.28 x 0.08	2.6	2.6	2.6	2.6	-	-	-	-	-	-	
5.6	565	0.807	0.807	0.315	0.701	0.28 x 0.08	4	4	4	-	-	-	-	-	-	-	
6.8	685	0.807	0.807	0.315	0.701	0.28 x 0.08	5	5	5	-	-	-	-	-	-	-	
10	106	0.807	0.807	0.315	0.701	0.28 x 0.08	6.4	6.4	-	-	-	-	-	-	-	-	
15	156	0.807	0.807	0.315	0.701	0.28 x 0.08	6.3	-	-	-	-	-	-	-	-	-	

RMS current rated at 300kHz up to 105°C.

CAPACITORS FOR HIGH FREQUENCY SWITCH MODE POWER SUPPLIES

TYPE DPM 907 N

STANDARD RATINGS

Capacitance		Dimensions (in inches)					TYPE DPM 907 N									
µF	Code	Max. "L"	Max. "E"	Max. "H"	"X" + /- 0.02	Nb con± 0.5% / +10% -0.05	63 V (l. rms)	100 V (l. rms)	160 V (l. rms)	250 V (l. rms)	400 V (l. rms)	500 V (l. rms)	630 V (l. rms)	800 V (l. rms)	1,000 V (l. rms)	1,250 V (l. rms)
0.12	124	0.807	0.807	0.492	0.701	0.28 x 0.08	0.8	0.8	0.8	0.8	0.8	0.8	0.8	0.8	0.8	0.8
0.15	154	0.807	0.807	0.492	0.701	0.28 x 0.08	1	1	1	1	1	1	1	1	1	1
0.18	184	0.807	0.807	0.492	0.701	0.28 x 0.08	1.2	1.2	1.2	1.2	1.2	1.2	1.2	1.2	1.2	1.2
0.22	224	0.807	0.807	0.492	0.701	0.28 x 0.08	1.5	1.5	1.5	1.5	1.5	1.5	1.5	1.5	1.5	1.5
0.27	274	0.807	0.807	0.492	0.701	0.28 x 0.08	1.4	1.4	1.4	1.4	1.4	1.4	1.4	1.4	1.4	-
0.33	334	0.807	0.807	0.492	0.701	0.28 x 0.08	1.7	1.7	1.7	1.7	1.7	1.7	1.7	1.7	1.7	-
0.39	394	0.807	0.807	0.492	0.701	0.28 x 0.08	1.6	1.6	1.6	1.6	1.6	1.6	1.6	1.6	2	-
0.47	474	0.807	0.807	0.492	0.701	0.28 x 0.08	1.9	1.9	1.9	1.9	1.9	1.9	1.9	1.9	-	-
0.56	564	0.807	0.807	0.492	0.701	0.28 x 0.08	2.3	2.3	2.3	2.3	2.3	2.3	2.3	2.3	-	-
0.68	684	0.807	0.807	0.492	0.701	0.28 x 0.08	2.5	2.5	2.5	2.5	2.5	2.5	2.5	2.8	-	-
0.82	824	0.807	0.807	0.492	0.701	0.28 x 0.08	3	3	3	3	3	3	3	-	-	-
1	105	0.807	0.807	0.492	0.701	0.28 x 0.08	3.2	3.2	3.2	3.2	3.2	3.2	3.2	-	-	-
1.2	125	0.807	0.807	0.492	0.701	0.28 x 0.08	3.3	3.3	3.3	3.3	3.3	3.3	-	-	-	-
1.5	155	0.807	0.807	0.492	0.701	0.28 x 0.08	4.7	4.7	4.7	4.7	4.7	4.7	-	-	-	-
1.8	185	0.807	0.807	0.492	0.701	0.28 x 0.08	4	4	4	4	4	-	-	-	-	-
2.2	225	0.807	0.807	0.492	0.701	0.28 x 0.08	4.5	4.5	4.5	4.5	4.5	-	-	-	-	-
2.7	275	0.807	0.807	0.492	0.701	0.28 x 0.08	5	5	5	5	5	-	-	-	-	-
3.9	395	0.807	0.807	0.492	0.701	0.28 x 0.08	3.1	3.1	3.1	3.1	-	-	-	-	-	-
4.7	475	0.807	0.807	0.492	0.701	0.28 x 0.08	3.7	3.7	3.7	3.7	-	-	-	-	-	-
5.6	565	0.807	0.807	0.492	0.701	0.28 x 0.08	4.4	4.4	4.4	4.4	-	-	-	-	-	-
8.2	825	0.807	0.807	0.492	0.701	0.28 x 0.08	6	6	6	-	-	-	-	-	-	-
10	106	0.807	0.807	0.492	0.701	0.28 x 0.08	7.3	7.3	7.3	-	-	-	-	-	-	-
12	126	0.807	0.807	0.492	0.701	0.28 x 0.08	6.4	6.4	-	-	-	-	-	-	-	-
15	156	0.807	0.807	0.492	0.701	0.28 x 0.08	8	8	-	-	-	-	-	-	-	-
18	186	0.807	0.807	0.492	0.701	0.28 x 0.08	7.6	8	-	-	-	-	-	-	-	-
22	226	0.807	0.807	0.492	0.701	0.28 x 0.08	8	8	-	-	-	-	-	-	-	-
0.27	274	0.807	0.807	0.788	0.701	0.28 x 0.08	1.8	1.8	1.8	1.8	1.8	1.8	1.8	1.8	1.8	1.8
0.33	334	0.807	0.807	0.788	0.701	0.28 x 0.08	2.2	2.2	2.2	2.2	2.2	2.2	2.2	2.2	2.2	2.2
0.39	394	0.807	0.807	0.788	0.701	0.28 x 0.08	2.6	2.6	2.6	2.6	2.6	2.6	2.6	2.6	2.6	2.6
0.47	474	0.807	0.807	0.788	0.701	0.28 x 0.08	2.5	2.5	2.5	2.5	2.5	2.5	2.5	2.5	2.5	-
0.56	564	0.807	0.807	0.788	0.701	0.28 x 0.08	2.9	2.9	2.9	2.9	2.9	2.9	2.9	2.9	2.9	-
0.68	684	0.807	0.807	0.788	0.701	0.28 x 0.08	3.4	3.4	3.4	3.4	3.4	3.4	3.4	3.4	3.4	-
0.82	82	0.807	0.807	0.788	0.701	0.28 x 0.08	3.4	3.4	3.4	3.4	3.4	3.4	3.4	3.4	-	-
1	105	0.807	0.807	0.788	0.701	0.28 x 0.08	4.1	4.1	4.1	4.1	4.1	4.1	4.1	4.1	-	-
1.2	125	0.807	0.807	0.788	0.701	0.28 x 0.08	3.9	3.9	3.9	3.9	3.9	3.9	3.9	-	-	-
1.5	155	0.807	0.807	0.788	0.701	0.28 x 0.08	5	5	5	5	5	5	5	-	-	-
1.8	185	0.807	0.807	0.788	0.701	0.28 x 0.08	5	5	5	5	5	5	5.8	-	-	-
2.2	225	0.807	0.807	0.788	0.701	0.28 x 0.08	6.3	6.3	6.3	6.3	6.3	6.3	-	-	-	-
2.7	275	0.807	0.807	0.788	0.701	0.28 x 0.08	6.3	6.3	6.3	6.3	6.3	6.3	-	-	-	-
3.3	335	0.807	0.807	0.788	0.701	0.28 x 0.08	5	5	5	5	5	-	-	-	-	-
3.9	395	0.807	0.807	0.788	0.701	0.28 x 0.08	5.9	5.9	5.9	5.9	5.9	-	-	-	-	-
4.7	475	0.807	0.807	0.788	0.701	0.28 x 0.08	7.1	7.1	7.1	7.1	7.1	-	-	-	-	-
6.8	685	0.807	0.807	0.788	0.701	0.28 x 0.08	5.4	5.4	5.4	5.4	-	-	-	-	-	-
8.2	825	0.807	0.807	0.788	0.701	0.28 x 0.08	6.5	6.5	6.5	6.5	-	-	-	-	-	-
10	106	0.807	0.807	0.788	0.701	0.28 x 0.08	7.9	7.9	7.9	7.9	-	-	-	-	-	-
12	126	0.807	0.807	0.788	0.701	0.28 x 0.08	8	8	8	-	-	-	-	-	-	-
15	156	0.807	0.807	0.788	0.701	0.28 x 0.08	10	10	10	-	-	-	-	-	-	-
18	186	0.807	0.807	0.788	0.701	0.28 x 0.08	10	10	10	-	-	-	-	-	-	-
27	276	0.807	0.807	0.788	0.701	0.28 x 0.08	10	10	-	-	-	-	-	-	-	-
33	336	0.807	0.807	0.788	0.701	0.28 x 0.08	10	10	-	-	-	-	-	-	-	-
39	396	0.807	0.807	0.788	0.701	0.28 x 0.08	11.8	-	-	-	-	-	-	-	-	-

RMS current rated at 300kHz up to 105°C.

CAPACITORS FOR HIGH FREQUENCY SWITCH MODE POWER SUPPLIES

STANDARD RATINGS

							TYPE DPM 907 N										
Capacitance		Dimensions (in inches)					Nb con± 0.5% / +10% -0.05	63 V (l. rms)	100 V (l. rms)	160 V (l. rms)	250 V (l. rms)	400 V (l. rms)	500 V (l. rms)	630 V (l. rms)	800 V (l. rms)	1,000 V (l. rms)	1,250 V (l. rms)
µF	Code	Max. "L"	Max. "E"	Max. "H"	"X" + / - 0.02												
0.47	474	0.807	0.807	1.181	0.701	0.28 x 0.08	3.1	3.1	3.1	3.1	3.1	3.1	3.1	3.1	3.1	3.1	3.1
0.56	564	0.807	0.807	1.181	0.701	0.28 x 0.08	3.7	3.7	3.7	3.7	3.7	3.7	3.7	3.7	3.7	3.7	3.7
0.82	824	0.807	0.807	1.181	0.701	0.28 x 0.08	4.3	4.3	4.3	4.3	4.3	4.3	4.3	4.3	4.3	4.3	-
1	105	0.807	0.807	1.181	0.701	0.28 x 0.08	5.2	5.2	5.2	5.2	5.2	5.2	5.2	5.2	5.2	5.2	-
1.2	125	0.807	0.807	1.181	0.701	0.28 x 0.08	5	5	5	5	5	5	5	5	5	-	-
1.5	155	0.807	0.807	1.181	0.701	0.28 x 0.08	6.2	6.2	6.2	6.2	6.2	6.2	6.2	6.2	6.2	-	-
2.2	225	0.807	0.807	1.181	0.701	0.28 x 0.08	7.2	7.2	7.2	7.2	7.2	7.2	7.2	-	-	-	-
2.7	275	0.807	0.807	1.181	0.701	0.28 x 0.08	8.8	8.8	8.8	8.8	8.8	8.8	8.8	-	-	-	-
3.3	335	0.807	0.807	1.181	0.701	0.28 x 0.08	6.3	6.3	6.3	6.3	6.3	6.3	10.8	-	-	-	-
3.9	395	0.807	0.807	1.181	0.701	0.28 x 0.08	8	8	8	8	8	8	-	-	-	-	-
4.7	475	0.807	0.807	1.181	0.701	0.28 x 0.08	8	8	8	8	8	8	-	-	-	-	-
5.6	565	0.807	0.807	1.181	0.701	0.28 x 0.08	7.9	7.9	7.9	7.9	7.9	-	-	-	-	-	-
6.8	685	0.807	0.807	1.181	0.701	0.28 x 0.08	9.6	9.6	9.6	9.6	9.6	-	-	-	-	-	-
8.2	825	0.807	0.807	1.181	0.701	0.28 x 0.08	11.5	11.5	11.5	11.5	11.5	-	-	-	-	-	-
12	126	0.807	0.807	1.181	0.701	0.28 x 0.08	9.5	9.5	9.5	9.5	-	-	-	-	-	-	-
15	156	0.807	0.807	1.181	0.701	0.28 x 0.08	11.9	11.9	11.9	11.9	-	-	-	-	-	-	-
18	186	0.807	0.807	1.181	0.701	0.28 x 0.08	12.5	12.5	12.5	12.5	-	-	-	-	-	-	-
22	226	0.807	0.807	1.181	0.701	0.28 x 0.08	10	10	10	-	-	-	-	-	-	-	-
27	276	0.807	0.807	1.181	0.701	0.28 x 0.08	12.5	12.5	12.5	-	-	-	-	-	-	-	-
33	336	0.807	0.807	1.181	0.701	0.28 x 0.08	12.5	12.5	12.5	-	-	-	-	-	-	-	-
39	396	0.807	0.807	1.181	0.701	0.28 x 0.08	12.5	12.5	-	-	-	-	-	-	-	-	-
47	476	0.807	0.807	1.181	0.701	0.28 x 0.08	12.5	12.5	-	-	-	-	-	-	-	-	-
56	566	0.807	0.807	1.181	0.701	0.28 x 0.08	12.5	-	-	-	-	-	-	-	-	-	-
0.68	684	1.24	1.28	0.866	1.1	0.43 x 0.08	2.4	2.4	2.4	2.4	2.4	2.4	2.4	2.4	2.4	2.4	2.4
1	105	1.24	1.28	0.866	1.1	0.43 x 0.08	3.6	3.6	3.6	3.6	3.6	3.6	3.6	3.6	3.6	3.6	3.6
1.2	12	1.24	1.28	0.866	1.1	0.43 x 0.08	3.4	3.4	3.4	3.4	3.4	3.4	3.4	3.4	3.4	3.4	4.3
1.5	155	1.24	1.28	0.866	1.1	0.43 x 0.08	4.3	4.3	4.3	4.3	4.3	4.3	4.3	4.3	4.3	4.3	5.4
1.8	185	1.24	1.28	0.866	1.1	0.43 x 0.08	4.3	4.3	4.3	4.3	4.3	4.3	4.3	4.3	4.3	5.1	-
2.2	225	1.24	1.28	0.866	1.1	0.43 x 0.08	5.2	5.2	5.2	5.2	5.2	5.2	5.2	5.2	5.2	6.2	-
2.7	275	1.24	1.28	0.866	1.1	0.43 x 0.08	6.4	6.4	6.4	6.4	6.4	6.4	6.4	6.4	6.4	-	-
3.3	335	1.24	1.28	0.866	1.1	0.43 x 0.08	7.8	7.8	7.8	7.8	7.8	7.8	7.8	7.8	7.8	-	-
3.9	395	1.24	1.28	0.866	1.1	0.43 x 0.08	7	7	7	7	7	7	7	-	-	-	-
4.7	475	1.24	1.28	0.866	1.1	0.43 x 0.08	8.5	8.5	8.5	8.5	8.5	8.5	8.5	-	-	-	-
5.6	565	1.24	1.28	0.866	1.1	0.43 x 0.08	7.9	7.9	7.9	7.9	7.9	7.9	10.1	-	-	-	-
6.8	685	1.24	1.28	0.866	1.1	0.43 x 0.08	9.6	9.6	9.6	9.6	9.6	9.6	-	-	-	-	-
8.2	825	1.24	1.28	0.866	1.1	0.43 x 0.08	11.5	11.5	11.5	11.5	11.5	11.5	-	-	-	-	-
10	106	1.24	1.28	0.866	1.1	0.43 x 0.08	11.2	11.2	11.2	11.2	11.2	14	-	-	-	-	-
12	126	1.24	1.28	0.866	1.1	0.43 x 0.08	13.4	13.4	13.4	13.4	13.4	-	-	-	-	-	-
15	156	1.24	1.28	0.866	1.1	0.43 x 0.08	15	15	15	15	15	-	-	-	-	-	-
22	226	1.24	1.28	0.866	1.1	0.43 x 0.08	9.9	9.9	9.9	9.9	-	-	-	-	-	-	-
27	276	1.24	1.28	0.866	1.1	0.43 x 0.08	12.1	12.1	12.1	12.1	-	-	-	-	-	-	-
33	336	1.24	1.28	0.866	1.1	0.43 x 0.08	14.9	14.9	14.9	14.9	-	-	-	-	-	-	-
39	396	1.24	1.28	0.866	1.1	0.43 x 0.08	15	45	15	-	-	-	-	-	-	-	-
47	476	1.24	1.28	0.866	1.1	0.43 x 0.08	15	15	15	-	-	-	-	-	-	-	-
56	566	1.24	1.28	0.866	1.1	0.43 x 0.08	15	15	15	-	-	-	-	-	-	-	-
68	686	1.24	1.28	0.866	1.1	0.43 x 0.08	15	15	-	-	-	-	-	-	-	-	-
82	826	1.24	1.28	0.866	1.1	0.43 x 0.08	15	15	-	-	-	-	-	-	-	-	-
100	107	1.24	1.28	0.866	1.1	0.43 x 0.08	15	15	-	-	-	-	-	-	-	-	-
120	127	1.24	1.28	0.866	1.1	0.43 x 0.08	15	-	-	-	-	-	-	-	-	-	-

RMS current rated at 300kHz up to 105°C.

CAPACITORS FOR HIGH FREQUENCY SWITCH MODE POWER SUPPLIES

TYPE DPM 907 N

STANDARD RATINGS

Capacitance		Dimensions (in inches)					TYPE DPM 907 N										
μF	Code	Max. "L"	Max. "E"	Max. "H"	"X" + / - 0.02	Nb con± 0.5% / +10% -0.05	63 V	100 V	160 V	250 V	400 V	500 V	630 V	800 V	1,000 V	1,250 V	
							(l. rms)	(l. rms)	(l. rms)	(l. rms)	(l. rms)	(l. rms)	(l. rms)	(l. rms)	(l. rms)	(l. rms)	(l. rms)
1.8	185	1.24	1.28	1.26	1.1	0.43 x 0.08	6.5	6.5	6.5	6.5	6.5	6.5	6.5	6.5	6.5	6.5	
2.2	225	1.24	1.28	1.26	1.1	0.43 x 0.08	7.9	7.9	7.9	7.9	7.9	7.9	7.9	7.9	7.9	7.9	
2.7	275	1.24	1.28	1.26	1.1	0.43 x 0.08	7.7	7.7	7.7	7.7	7.7	7.7	7.7	7.7	7.7	-	
3.3	335	1.24	1.28	1.26	1.1	0.43 x 0.08	9.4	9.4	9.4	9.4	9.4	9.4	9.4	9.4	9.4	-	
3.9	395	1.24	1.28	1.26	1.1	0.43 x 0.08	9.2	9.2	9.2	9.2	9.2	9.2	9.2	9.2	11	-	
4.7	475	1.24	1.28	1.26	1.1	0.43 x 0.08	11	11	11	11	11	11	11	11	-	-	
5.6	565	1.24	1.28	1.26	1.1	0.43 x 0.08	12.5	12.5	12.5	12.5	12.5	12.5	12.5	12.5	-	-	
6.8	685	1.24	1.28	1.26	1.1	0.43 x 0.08	12.3	12.3	12.3	12.3	12.3	12.3	12.3	-	-	-	
8.2	825	1.24	1.28	1.26	1.1	0.43 x 0.08	14.7	14.7	14.7	14.7	14.7	14.7	14.7	-	-	-	
10	106	1.24	1.28	1.26	1.1	0.43 x 0.08	15	15	15	15	15	15	15	-	-	-	
12	126	1.24	1.28	1.26	1.1	0.43 x 0.08	15	15	15	15	15	15	-	-	-	-	
15	156	1.24	1.28	1.26	1.1	0.43 x 0.08	15	15	15	15	15	15	-	-	-	-	
18	186	1.24	1.28	1.26	1.1	0.43 x 0.08	15	15	15	15	15	-	-	-	-	-	
22	226	1.24	1.28	1.26	1.1	0.43 x 0.08	15	15	15	15	15	-	-	-	-	-	
39	396	1.24	1.28	1.26	1.1	0.43 x 0.08	15	15	15	15	-	-	-	-	-	-	
47	476	1.24	1.28	1.26	1.1	0.43 x 0.08	15	15	15	15	-	-	-	-	-	-	
56	566	1.24	1.28	1.26	1.1	0.43 x 0.08	15	15	15	15	-	-	-	-	-	-	
68	686	1.24	1.28	1.26	1.1	0.43 x 0.08	15	15	15	-	-	-	-	-	-	-	
82	826	1.24	1.28	1.26	1.1	0.43 x 0.08	15	15	15	-	-	-	-	-	-	-	
100	107	1.24	1.28	1.26	1.1	0.43 x 0.08	15	15	15	-	-	-	-	-	-	-	
120	127	1.24	1.28	1.26	1.1	0.43 x 0.08	15	15	-	-	-	-	-	-	-	-	
150	157	1.24	1.28	1.26	1.1	0.43 x 0.08	15	15	-	-	-	-	-	-	-	-	
180	187	1.24	1.28	1.26	1.1	0.43 x 0.08	15	-	-	-	-	-	-	-	-	-	

RMS current rated at 300kHz up to 105°C.

CAPACITORS FOR HIGH FREQUENCY SWITCH MODE POWER SUPPLIES



PHYSICAL CHARACTERISTICS

CONSTRUCTION:

Dielectric: Metalized Polyester (P.E.T.). Self healing, low inductance.

CASE:

Thermoplastic case. Epoxy resin molded.

LEAD MATERIAL:

DPM 90 R1 & R2 - Surface mount device.

MARKING:

Dearborn trademark, type or catalog number, capacitance, tolerance and voltage.

ELECTRICAL SPECIFICATIONS

OPERATING TEMPERATURE RANGE:

-55°C to +125°C

DISSIPATION FACTOR:

Maximum 1% @ 1kHz

INSULATION RESISTANCE:

$\geq 3,750 \text{ M}\Omega$ for $C_R \leq 0.33$ and $\leq 100 \text{ VDC}$

$\geq 7,500 \text{ M}\Omega$ for $C_R \leq 0.33$ and $> 100 \text{ VDC}$

$\geq 1,250 \text{ M}\Omega \cdot \mu\text{F}$ for $C_R > 0.33$ and $\leq 100 \text{ VDC}$

$\geq 2,500 \text{ M}\Omega \cdot \mu\text{F}$ for $C_R > 0.33$ and $> 100 \text{ VDC}$

DIELECTRIC WITHSTANDING VOLTAGE (DWW):

1.6 x rated voltage

INSULATION BETWEEN LEADS & CASE:

50,000 $\text{M}\Omega$

PERMISSIBLE CURRENT:

@ 300kHz up to 105°C = I_{rms}

@ 300kHz at 125°C = $0.1 I_{\text{rms}}$

AVAILABLE CAPACITANCE TOLERANCES:

$\pm 20\%$ & $\pm 10\%$

DIMENSIONS (in inches)

DPM 90 R1

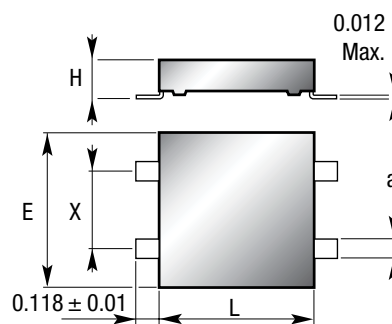

DPM 90 R2

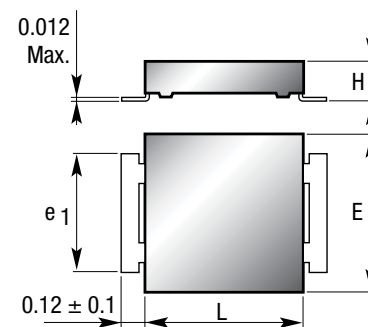

CAPACITORS FOR HIGH FREQUENCY SWITCH MODE POWER SUPPLIES

TYPE DPM 90 R1 / R2

STANDARD RATINGS

Capacitance		Dimensions (in inches)						TYPE DPM 90 M R1 / R2	TYPE DPM 90 R1 / R2					
μF	Code	Max. "L"	Max. "E"	Max. "H"	"e1" ± 0.02	"X" ± 0.02	"a" $+10\% -0.05$	50 V (l. rms)	50 V (l. rms)	100 V (l. rms)	200 V (l. rms)	250 V (l. rms)	400 V (l. rms)	630 V (l. rms)
0.22	224	0.807	0.807	0.295	0.591	0.394	0.1	-	0.9	0.9	0.9	0.9	0.9	0.9
0.27	274	0.807	0.807	0.295	0.591	0.394	0.1	-	1.1	1.1	1.1	1.1	1.1	1.1
0.39	394	0.807	0.807	0.295	0.591	0.394	0.1	-	1.25	1.25	1.25	1.25	1.25	-
0.47	474	0.807	0.807	0.295	0.591	0.394	0.1	-	1.6	1.6	1.6	1.6	1.6	-
0.56	564	0.807	0.807	0.295	0.591	0.394	0.1	-	2	2	2	2	2	-
0.68	684	0.807	0.807	0.295	0.591	0.394	0.1	-	2.5	2.5	2.5	2.5	2.5	-
0.82	824	0.807	0.807	0.295	0.591	0.394	0.1	-	3.15	3.15	3.15	3.15	3.15	-
1	105	0.807	0.807	0.295	0.591	0.394	0.1	-	1.25	1.25	1.25	1.25	-	-
1.2	125	0.807	0.807	0.295	0.591	0.394	0.1	-	1.6	1.6	1.6	1.6	-	-
1.5	155	0.807	0.807	0.295	0.591	0.394	0.1	-	1.5	1.5	1.5	2	-	-
1.8	185	0.807	0.807	0.295	0.591	0.394	0.1	-	2.5	2.5	2.5	2.5	-	-
2.2	225	0.807	0.807	0.295	0.591	0.394	0.1	-	2.2	2.2	2.2	3.15	-	-
2.7	275	0.807	0.807	0.295	0.591	0.394	0.1	-	4	4	4	4	-	-
3.3	335	0.807	0.807	0.295	0.591	0.394	0.1	-	2	2	2.6	-	-	-
3.9	395	0.807	0.807	0.295	0.591	0.394	0.1	-	2.5	2.5	-	-	-	-
4.7	475	0.807	0.807	0.295	0.591	0.394	0.1	-	3.15	3.15	-	-	-	-
5.6	565	0.807	0.807	0.295	0.591	0.394	0.1	-	4	4	-	-	-	-
6.8	685	0.807	0.807	0.295	0.591	0.394	0.1	-	5	5	-	-	-	-
8.2	825	0.807	0.807	0.295	0.591	0.394	0.1	-	4	-	-	-	-	-
10	106	0.807	0.807	0.295	0.591	0.394	0.1	-	5	-	-	-	-	-
12	126	0.807	0.807	0.295	0.591	0.394	0.1	-	6.3	-	-	-	-	-
15	156	0.807	0.807	0.295	0.591	0.394	0.1	5.2	-	-	-	-	-	-
0.33	334	0.807	0.807	0.355	0.591	0.394	0.1	-	1.4	1.4	1.4	1.4	1.4	1.4
0.39	394	0.807	0.807	0.355	0.591	0.394	0.1	-	1.6	1.6	1.6	1.6	1.6	1.6
1	105	0.807	0.807	0.355	0.591	0.394	0.1	-	4	4	4	4	4	-
1.2	125	0.807	0.807	0.355	0.591	0.394	0.1	-	4	4	4	4	4	-
3.3	335	0.807	0.807	0.355	0.591	0.394	0.1	-	5	5	5	5	-	-
3.9	395	0.807	0.807	0.355	0.591	0.394	0.1	-	3.1	3.1	3.1	5	-	-
4.7	475	0.807	0.807	0.355	0.591	0.394	0.1	-	3.7	3.7	3.7	-	-	-
8.2	825	0.807	0.807	0.355	0.591	0.394	0.1	-	6.5	6.5	-	-	-	-
15	156	0.807	0.807	0.355	0.591	0.394	0.1	-	8	-	-	-	-	-
18	186	0.807	0.807	0.355	0.591	0.394	0.1	6.2	-	-	-	-	-	-
22	226	0.807	0.807	0.355	0.591	0.394	0.1	7.6	-	-	-	-	-	-
0.47	474	0.807	0.807	0.532	0.591	0.394	0.1	-	1.9	1.9	1.9	1.9	1.9	1.9
0.68	684	0.807	0.807	0.532	0.591	0.394	0.1	-	2.8	2.8	2.8	2.8	2.8	2.8
1.5	155	0.807	0.807	0.532	0.591	0.394	0.1	-	5	5	5	5	5	-
1.8	185	0.807	0.807	0.532	0.591	0.394	0.1	-	5	5	5	5	5	-
4.7	475	0.807	0.807	0.532	0.591	0.394	0.1	-	6.3	6.3	6.3	6.3	-	-
5.6	565	0.807	0.807	0.532	0.591	0.394	0.1	-	4.4	4.4	4.4	6.3	-	-
6.8	685	0.807	0.807	0.532	0.591	0.394	0.1	-	5.4	5.4	5.4	-	-	-
10	106	0.807	0.807	0.532	0.591	0.394	0.1	-	8	8	-	-	-	-
12	126	0.807	0.807	0.532	0.591	0.394	0.1	-	8	8	-	-	-	-
18	186	0.807	0.807	0.532	0.591	0.394	0.1	-	10	-	-	-	-	-
22	226	0.807	0.807	0.532	0.591	0.394	0.1	-	10	-	-	-	-	-
27	276	0.807	0.807	0.532	0.591	0.394	0.1	-	9.4	-	-	-	-	-
33	336	0.807	0.807	0.532	0.591	0.394	0.1	11.5	-	-	-	-	-	-

RMS current rated at 300kHz up to 105°C.

CAPACITORS FOR HIGH FREQUENCY SWITCH MODE POWER SUPPLIES

STANDARD RATINGS

Capacitance		Dimensions (in inches)						TYPE DPM 90 M R1 / R2	TYPE DPM 90 R1 / R2					
µF	Code	Max. "L"	Max. "E"	Max. "H"	"e1" ± 0.02	"X" ± 0.02	"a" +10%-0.05	50 V (l. rms)	50 V (l. rms)	100 V (l. rms)	200 V (l. rms)	250 V (l. rms)	400 V (l. rms)	630 V (l. rms)
0.82	824	0.807	0.807	0.827	0.591	0.394	0.1	-	3.4	3.4	3.4	3.4	3.4	3.4
1	105	0.807	0.807	0.827	0.591	0.394	0.1	-	4.1	4.1	4.1	4.1	4.1	4.1
2.2	225	0.807	0.807	0.827	0.591	0.394	0.1	-	6.3	6.3	6.3	6.3	6.3	-
2.7	275	0.807	0.807	0.827	0.591	0.394	0.1	-	6.3	6.3	6.3	6.3	6.3	-
3.3	335	0.807	0.807	0.827	0.591	0.394	0.1	-	6.3	6.3	6.3	6.3	6.3	-
6.8	685	0.807	0.807	0.827	0.591	0.394	0.1	-	8	8	8	8	-	-
8.2	825	0.807	0.807	0.827	0.591	0.394	0.1	-	6.5	6.5	6.5	8	-	-
10	106	0.807	0.807	0.827	0.591	0.394	0.1	-	7.9	7.9	7.9	8	-	-
12	126	0.807	0.807	0.827	0.591	0.394	0.1	-	9.5	9.5	9.5	-	-	-
15	156	0.807	0.807	0.827	0.591	0.394	0.1	-	10	10	-	-	-	-
18	186	0.807	0.807	0.827	0.591	0.394	0.1	-	10	10	-	-	-	-
22	226	0.807	0.807	0.827	0.591	0.394	0.1	-	10	10	-	-	-	-
27	276	0.807	0.807	0.827	0.591	0.394	0.1	-	12.5	-	-	-	-	-
33	336	0.807	0.807	0.827	0.591	0.394	0.1	-	12.5	-	-	-	-	-
39	396	0.807	0.807	0.827	0.591	0.394	0.1	-	12.5	-	-	-	-	-
47	476	0.807	0.807	0.827	0.591	0.394	0.1	12.5	-	-	-	-	-	-
56	566	0.807	0.807	0.827	0.591	0.394	0.1	12.5	-	-	-	-	-	-
68	686	0.807	0.807	0.827	0.591	0.394	0.1	12.5	-	-	-	-	-	-
1.2	125	0.807	0.807	1.221	0.591	0.394	0.1	-	5	5	5	5	5	5
1.5	155	0.807	0.807	1.221	0.591	0.394	0.1	-	6.2	6.2	6.2	6.2	6.2	6.2
1.8	185	0.807	0.807	1.221	0.591	0.394	0.1	-	7.4	7.4	7.4	7.4	7.4	7.4
3.9	395	0.807	0.807	1.221	0.591	0.394	0.1	-	8	8	8	8	8	-
4.7	475	0.807	0.807	1.221	0.591	0.394	0.1	-	8	8	8	8	8	-
12	126	0.807	0.807	1.221	0.591	0.394	0.1	-	10	10	10	10	-	-
15	156	0.807	0.807	1.221	0.591	0.394	0.1	-	11.9	11.9	11.9	10	-	-
18	186	0.807	0.807	1.221	0.591	0.394	0.1	-	12.5	12.5	12.5	-	-	-
27	276	0.807	0.807	1.221	0.591	0.394	0.1	-	12.5	12.5	-	-	-	-
33	336	0.807	0.807	1.221	0.591	0.394	0.1	-	12.5	12.5	-	-	-	-
47	476	0.807	0.807	1.221	0.591	0.394	0.1	-	12.5	-	-	-	-	-
56	566	0.807	0.807	1.221	0.591	0.394	0.1	-	12.5	-	-	-	-	-
82	826	0.807	0.807	1.221	0.591	0.394	0.1	12.5	-	-	-	-	-	-
100	107	0.807	0.807	1.221	0.591	0.394	0.1	12.5	-	-	-	-	-	-
2.2	225	1.24	1.28	0.906	0.945	0.591	0.158	-	5.2	5.2	5.2	5.2	5.2	5.2
2.7	275	1.24	1.28	0.906	0.945	0.591	0.158	-	6.4	6.4	6.4	6.4	6.4	6.4
3.3	335	1.24	1.28	0.906	0.945	0.591	0.158	-	7.8	7.8	7.8	7.8	7.8	7.8
3.9	395	1.24	1.28	0.906	0.945	0.591	0.158	-	9.2	9.2	9.2	9.2	9.2	9.2
5.6	565	1.24	1.28	0.906	0.945	0.591	0.158	-	7.9	7.9	7.9	7.9	7.9	-
6.8	685	1.24	1.28	0.906	0.945	0.591	0.158	-	9.6	9.6	9.6	9.6	9.6	-
8.2	825	1.24	1.28	0.906	0.945	0.591	0.158	-	11.5	11.5	11.5	11.5	11.5	-
10	106	1.24	1.28	0.906	0.945	0.591	0.158	-	14	14	14	14	14	-
18	186	1.24	1.28	0.906	0.945	0.591	0.158	-	15	15	15	15	-	-
22	226	1.24	1.28	0.906	0.945	0.591	0.158	-	9.9	9.9	9.9	15	-	-
27	276	1.24	1.28	0.906	0.945	0.591	0.158	-	15	15	15	15	-	-
33	336	1.24	1.28	0.906	0.945	0.591	0.158	-	14.9	14.9	14.9	-	-	-
39	396	1.24	1.28	0.906	0.945	0.591	0.158	-	15	15	-	-	-	-
47	476	1.24	1.28	0.906	0.945	0.591	0.158	-	15	15	-	-	-	-
56	566	1.24	1.28	0.906	0.945	0.591	0.158	-	15	15	-	-	-	-
68	686	1.24	1.28	0.906	0.945	0.591	0.158	-	15	-	-	-	-	-
82	826	1.24	1.28	0.906	0.945	0.591	0.158	-	15	-	-	-	-	-
100	107	1.24	1.28	0.906	0.945	0.591	0.158	-	15	-	-	-	-	-

RMS current rated at 300kHz up to 105°C.

CAPACITORS FOR HIGH FREQUENCY SWITCH MODE POWER SUPPLIES

TYPE DPM 90 R1 / R2

STANDARD RATINGS

Capacitance		Dimensions (in inches)						TYPE DPM 90 M R1 / R2	TYPE DPM 90 R1 / R2					
μF	Code	Max. "L"	Max. "E"	Max. "H"	"e1" ± 0.02	"X" ± 0.02	"a" $+10\% -0.05$	50 V (l. rms)	50 V (l. rms)	100 V (l. rms)	200 V (l. rms)	250 V (l. rms)	400 V (l. rms)	630 V (l. rms)
4.7	475	1.24	1.28	1.3	0.945	0.591	0.158	-	11	11	11	11	11	11
5.6	565	1.24	1.28	1.3	0.945	0.591	0.158	-	12.5	12.5	12.5	12.5	12.5	12.5
12	126	1.24	1.28	1.3	0.945	0.591	0.158	-	15	15	15	15	15	-
15	156	1.24	1.28	1.3	0.945	0.591	0.158	-	15	15	15	15	15	-
33	336	1.24	1.28	1.3	0.945	0.591	0.158	-	15	15	15	15	-	-
39	396	1.24	1.28	1.3	0.945	0.591	0.158	-	15	15	15	15	-	-
47	476	1.24	1.28	1.3	0.945	0.591	0.158	-	15	15	15	-	-	-
56	566	1.24	1.28	1.3	0.945	0.591	0.158	-	15	15	15	-	-	-
68	686	1.24	1.28	1.3	0.945	0.591	0.158	-	15	15	-	-	-	-
82	826	1.24	1.28	1.3	0.945	0.591	0.158	-	15	15	-	-	-	-
100	107	1.24	1.28	1.3	0.945	0.591	0.158	-	15	15	-	-	-	-
120	127	1.24	1.28	1.3	0.945	0.591	0.158	-	15	-	-	-	-	-
150	157	1.24	1.28	1.3	0.945	0.591	0.158	-	15	-	-	-	-	-

RMS current rated at 300kHz up to 105°C.

CAPACITORS FOR HIGH FREQUENCY SWITCH MODE POWER SUPPLIES



PHYSICAL CHARACTERISTICS

CONSTRUCTION:

Dielectric: Metalized Polyester (P.E.T.). Self healing, low inductance.

CASE:

Thermoplastic case. Epoxy resin molded.

LEAD MATERIAL:

DPM 94 - Surface mount device.
DPM 94 N - Termination are "DIL" leads.

MARKING:

Dearborn trademark, type or catalog number, capacitance, tolerance and voltage.

ELECTRICAL SPECIFICATIONS

OPERATING TEMPERATURE RANGE:

-55°C to +125°C

DISSIPATION FACTOR:

Maximum 1% @ 1kHz

INSULATION RESISTANCE:

$\geq 3,750 \text{ M}\Omega$ for $C_R \leq 0.33$ and $\leq 100 \text{ VDC}$
 $\geq 7,500 \text{ M}\Omega$ for $C_R \leq 0.33$ and $> 100 \text{ VDC}$
 $\geq 1,250 \text{ M}\Omega \cdot \mu\text{F}$ for $C_R > 0.33$ and $\leq 100 \text{ VDC}$
 $\geq 2,500 \text{ M}\Omega \cdot \mu\text{F}$ or $C_R > 0.33$ and $> 100 \text{ VDC}$

DIELECTRIC WITHSTANDING VOLTAGE (DWV):

1.6 x rated voltage

INSULATION BETWEEN LEADS & CASE:

50,000 M Ω

PERMISSIBLE CURRENT:

@ 300kHz up to 105°C = I_{rms}
 @ 300kHz at 125°C = $0.1 I_{\text{rms}}$

AVAILABLE CAPACITANCE TOLERANCES:

$\pm 20\%$ & $\pm 10\%$

TOLERANCES FOR SMD LEADS ONLY

Model	R + / - 0.008	S + / - 0.008
DPM94-0	0.157	0.0394
DPM94-1	0.197	0.0591
DPM94-2	0.197	0.0591
DPM94-3	0.276	0.0787
DPM94-4	0.276	0.0787

TOLERANCES FOR DIL OUTPUTS ("N" MODELS ONLY)

Model	X + / - 0.016	NB Connections
DPM94-N-0	0.200	0.30 x 0.08
DPM94-N-1	0.325	0.16 x 0.08
DPM94-N-2	0.551	0.16 x 0.08
DPM94-N-3	0.551	0.20 x 0.08
DPM94-N-4	0.600	0.24 x 0.08

DIMENSIONS (in inches)

TYPE DPM 94

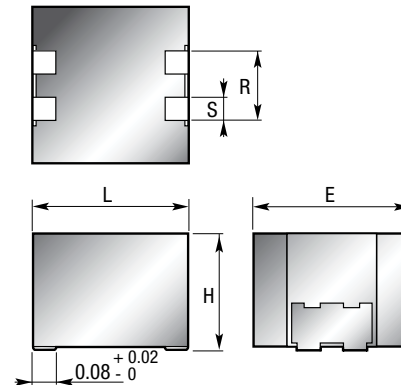

TYPE DPM 94 N

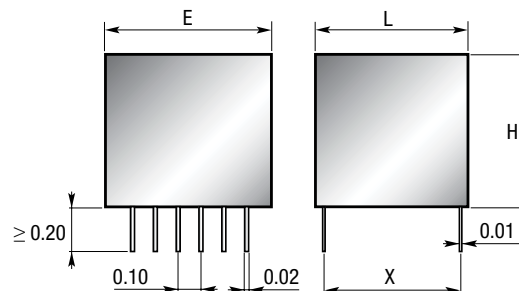

CAPACITORS FOR HIGH FREQUENCY SWITCH MODE POWER SUPPLIES

TYPE DPM 94 / DPM 94N

STANDARD RATINGS

TYPE DPM 94-0 / DPM 94-N-0										
Capacitance		Dimensions (in inches)			50 V	63 V	100 V	200 V	250 V	400 V
μF	Code	Max. "L"	Max. "E"	Max. "H"	(l. rms)	(l. rms)	(l. rms)	(l. rms)	(l. rms)	(l. rms)
0.0082	822	0.315	0.295	0.177	0.1	0.1	0.1	0.1	0.1	0.1
0.01	103	0.315	0.295	0.177	0.1	0.1	0.1	0.1	0.1	0.1
0.012	123	0.315	0.295	0.177	0.2	0.2	0.2	0.2	0.2	0.2
0.015	153	0.315	0.295	0.177	0.2	0.2	0.2	0.2	0.2	0.2
0.018	183	0.315	0.295	0.177	0.3	0.3	0.3	0.3	0.3	0.3
0.027	273	0.315	0.295	0.177	0.1	0.1	0.1	0.1	0.1	-
0.033	333	0.315	0.295	0.177	0.2	0.2	0.2	0.2	0.2	-
0.039	393	0.315	0.295	0.177	0.2	0.2	0.2	0.2	0.2	-
0.047	473	0.315	0.295	0.177	0.2	0.2	0.2	0.2	0.2	-
0.056	563	0.315	0.295	0.177	0.2	0.2	0.2	0.2	0.3	-
0.068	683	0.315	0.295	0.177	0.3	0.3	0.3	0.3	-	-
0.082	823	0.315	0.295	0.177	0.2	0.2	0.2	0.3	-	-
0.1	104	0.315	0.295	0.177	0.3	0.3	0.3	0.3	-	-
0.12	124	0.315	0.295	0.177	0.4	0.4	0.4	-	-	-
0.15	154	0.315	0.295	0.177	0.4	0.4	0.4	-	-	-
0.18	184	0.315	0.295	0.177	0.4	0.4	0.4	-	-	-
0.22	224	0.315	0.295	0.177	0.5	0.5	-	-	-	-
0.27	274	0.315	0.295	0.177	0.6	0.6	-	-	-	-
0.33	334	0.315	0.295	0.177	0.4	0.5	-	-	-	-
0.39	394	0.315	0.295	0.177	0.4	-	-	-	-	-
0.47	474	0.315	0.295	0.177	0.5	-	-	-	-	-
0.56	564	0.315	0.295	0.177	0.6	-	-	-	-	-
0.68	684	0.315	0.295	0.177	0.8	-	-	-	-	-
0.022	223	0.315	0.335	0.295	0.3	0.3	0.3	0.3	0.3	0.3
0.027	273	0.315	0.335	0.295	0.4	0.4	0.4	0.4	0.4	0.4
0.033	333	0.315	0.335	0.295	0.5	0.5	0.5	0.5	0.5	0.5
0.039	393	0.315	0.335	0.295	0.6	0.6	0.6	0.6	0.6	0.6
0.047	473	0.315	0.335	0.295	0.7	0.7	0.7	0.7	0.6	0.7
0.056	563	0.315	0.335	0.295	0.8	0.8	0.8	0.8	0.8	0.8
0.068	683	0.315	0.335	0.295	0.3	0.3	0.3	0.3	0.3	-
0.082	823	0.315	0.335	0.295	0.4	0.4	0.4	0.3	0.4	-
0.1	104	0.315	0.335	0.295	0.5	0.5	0.5	0.5	0.5	-
0.12	124	0.315	0.335	0.295	0.6	0.6	0.6	0.6	0.6	-
0.15	154	0.315	0.335	0.295	0.7	0.7	0.7	0.7	0.7	-
0.18	184	0.315	0.335	0.295	0.8	0.8	0.8	0.8	0.8	-
0.22	224	0.315	0.335	0.295	0.7	0.7	0.7	0.7	-	-
0.27	274	0.315	0.335	0.295	0.8	0.8	0.8	0.8	-	-
0.33	334	0.315	0.335	0.295	0.9	0.9	0.9	-	-	-
0.39	394	0.315	0.335	0.295	0.8	0.8	1	-	-	-
0.47	574	0.315	0.335	0.295	1	1	1.1	-	-	-
0.56	564	0.315	0.335	0.295	1.2	1.2	1.3	-	-	-
0.68	684	0.315	0.335	0.295	1.4	1.4	-	-	-	-
0.82	824	0.315	0.335	0.295	0.9	1.1	-	-	-	-
1	105	0.315	0.335	0.295	1.1	1.4	-	-	-	-
1.2	125	0.315	0.335	0.295	1.4	-	-	-	-	-
1.5	155	0.315	0.335	0.295	1.7	-	-	-	-	-
1.8	185	0.315	0.335	0.295	2	-	-	-	-	-

RMS current rated at 300kHz up to 105°C.

CAPACITORS FOR HIGH FREQUENCY SWITCH MODE POWER SUPPLIES

STANDARD RATINGS

TYPE DPM 94-1 / DPM 94-N-1											
Capacitance		Dimensions (in inches)			50 V	63 V	100 V	200 V	250 V	400 V	
µF	Code	Max. "L"	Max. "E"	Max. "H"	(l. rms)	(l. rms)	(l. rms)	(l. rms)	(l. rms)	(l. rms)	(l. rms)
0.1	104	0.421	0.421	0.236	0.8	0.8	0.8	0.8	0.8	0.8	0.8
0.22	224	0.421	0.421	0.236	0.8	0.8	0.8	0.8	0.8	0.8	-
0.27	274	0.421	0.421	0.236	1	1	1	1	1	1	-
0.33*	334	0.421	0.421	0.236	0.6	0.6	0.6	0.6	1.2	-	-
0.39	394	0.421	0.421	0.236	0.8	0.8	0.8	0.8	-	-	-
0.47	474	0.421	0.421	0.236	1	1	1	1	-	-	-
0.56	564	0.421	0.421	0.236	0.8	0.8	0.8	-	-	-	-
0.68	684	0.421	0.421	0.236	1	1	1	-	-	-	-
0.82	824	0.421	0.421	0.236	1.1	1.1	1.1	-	-	-	-
1	105	0.421	0.421	0.236	1.8	1.8	1.8	-	-	-	-
1.5	155	0.421	0.421	0.236	1.7	1.7	-	-	-	-	-
1.8	185	0.421	0.421	0.236	2.1	2.1	-	-	-	-	-
2.2	225	0.421	0.421	0.236	1.3	-	-	-	-	-	-
2.7	275	0.421	0.421	0.236	1.6	-	-	-	-	-	-
3.3	335	0.421	0.421	0.236	1.9	-	-	-	-	-	-
0.15	154	0.421	0.421	0.315	1.2	1.2	1.2	1.2	1.2	1.2	1.2
0.39	394	0.421	0.421	0.315	1.4	1.4	1.4	1.4	1.4	1.4	-
0.47	474	0.421	0.421	0.315	1.7	1.7	1.7	1.7	1.7	1.7	-
0.56	564	0.421	0.421	0.315	1.1	1.1	1.1	1.1	-	-	-
0.68	684	0.421	0.421	0.315	1.4	1.4	1.4	1.4	-	-	-
1.2	125	0.421	0.421	0.315	1.8	1.8	1.8	-	-	-	-
1.5	155	0.421	0.421	0.315	2.2	2.2	2.2	-	-	-	-
2.2	225	0.421	0.421	0.315	2.5	2.5	-	-	-	-	-
3.9	395	0.421	0.421	0.315	2.3	-	-	-	-	-	-
4.7	475	0.421	0.421	0.315	2.8	-	-	-	-	-	-
0.22	224	0.421	0.421	0.394	1.7	1.7	1.7	1.7	1.7	1.7	1.7
0.56	564	0.421	0.421	0.394	2	2	2	2	2	2	-
0.82	824	0.421	0.421	0.394	1.7	1.7	1.7	1.7	-	-	-
1.8	185	0.421	0.421	0.394	2.7	2.7	2.7	-	-	-	-
2.7	275	0.421	0.421	0.394	3.1	3.1	-	-	-	-	-
3.3	335	0.421	0.421	0.394	3.8	3.8	-	-	-	-	-
5.6	565	0.421	0.421	0.394	3.3	-	-	-	-	-	-
6.8	685	0.421	0.421	0.394	4.1	-	-	-	-	-	-
0.68	684	0.421	0.421	0.473	2.4	2.4	2.4	2.4	2.4	2.4	-
1	105	0.421	0.421	0.473	2.1	2.1	2.1	2.1	-	-	-
2.2	225	0.421	0.421	0.473	2.1	2.1	3.5	-	-	-	-
3.9	395	0.421	0.421	0.473	4.9	4.9	-	-	-	-	-
4.7	475	0.421	0.421	0.473	6	6	-	-	-	-	-
8.2	825	0.315	0.421	0.473	4.9	-	-	-	-	-	-
10	1005	0.315	0.421	0.473	6	-	-	-	-	-	-

RMS current rated at 300kHz up to 105°C.

CAPACITORS FOR HIGH FREQUENCY SWITCH MODE POWER SUPPLIES

STANDARD RATINGS

TYPE DPM 94-2 / DPM 94-N-2										
Capacitance		Dimensions (in inches)			50 V	63 V	100 V	200 V	250 V	400 V
μF	Code	Max. "L"	Max. "E"	Max. "H"	(l. rms)	(l. rms)	(l. rms)	(l. rms)	(l. rms)	(l. rms)
0.22	224	0.61	0.453	0.236	0.8	0.8	0.8	0.8	0.8	0.8
0.27	274	0.61	0.453	0.236	1	1	1	1	1	1
0.47	474	0.61	0.453	0.236	0.8	0.8	0.8	0.8	0.8	-
0.56	564	0.61	0.453	0.236	0.9	0.9	0.9	0.9	0.9	-
0.68	684	0.61	0.453	0.236	1.1	1.1	1.1	1.1	1.1	-
0.82	824	0.61	0.453	0.236	0.8	0.8	0.8	0.8	-	-
1	105	0.61	0.453	0.236	1	1	1	1	-	-
1.5	155	0.61	0.453	0.236	1.1	1.1	1.1	-	-	-
1.8	185	0.61	0.453	0.236	1.4	1.4	1.4	-	-	-
2.2	225	0.61	0.453	0.236	1.7	1.7	1.7	-	-	-
3.3	335	0.61	0.453	0.236	1.9	1.9	-	-	-	-
3.9	395	0.61	0.453	0.236	2.3	2.3	-	-	-	-
4.7	475	0.61	0.453	0.236	1.4	-	-	-	-	-
5.6	565	0.61	0.453	0.236	1.7	-	-	-	-	-
6.8	685	0.61	0.453	0.236	2.1	-	-	-	-	-
0.33	334	0.61	0.453	0.315	1.2	1.2	1.2	1.2	1.2	1.2
0.39	394	0.61	0.453	0.315	1.4	1.4	1.4	1.4	1.4	1.4
0.82	824	0.61	0.453	0.315	1.3	1.3	1.3	1.3	1.3	-
1	105	0.61	0.453	0.315	1.6	1.6	1.6	1.6	1.6	-
1.2	125	0.61	0.453	0.315	1.2	1.2	1.2	1.2	-	-
1.5	155	0.61	0.453	0.315	1.5	1.5	1.5	1.5	-	-
2.7	275	0.61	0.453	0.315	2.1	2.1	2.1	-	-	-
4.7	475	0.61	0.453	0.315	2.8	2.8	-	-	-	-
8.2	825	0.61	0.453	0.315	2.5	-	-	-	-	-
10	106	0.61	0.453	0.315	3.1	-	-	-	-	-
12	126	0.61	0.453	0.315	3.7	-	-	-	-	-
0.47	224	0.61	0.453	0.394	1.7	1.7	1.7	1.7	1.7	1.7
1.2	125	0.61	0.453	0.394	2	2	2	2	2	-
1.5	1.5	0.61	0.453	0.394	2.5	2.5	2.5	2.5	2.5	-
1.8	185	0.61	0.453	0.394	1.8	1.8	1.8	1.8	-	-
3.3	335	0.61	0.453	0.394	2.5	2.5	2.5	-	-	-
5.6	565	0.61	0.453	0.394	3.3	3.3	-	-	-	-
15	156	0.61	0.453	0.394	4.6	-	-	-	-	-

RMS current rated at 300kHz up to 105°C.

CAPACITORS FOR HIGH FREQUENCY SWITCH MODE POWER SUPPLIES

STANDARD RATINGS

TYPE DPM 94-3 / DPM 94-N-3										
Capacitance		Dimensions (in inches)			50 V	63 V	100 V	200 V	250 V	400 V
µF	Code	Max. "L"	Max. "E"	Max. "H"	(l. rms)	(l. rms)	(l. rms)	(l. rms)	(l. rms)	(l. rms)
0.47	474	0.65	0.61	0.236	1.6	1.6	1.6	1.6	1.6	1.6
1	105	0.65	0.61	0.236	1.5	1.5	1.5	1.5	1.5	-
1.2	125	0.65	0.61	0.236	1.1	1.1	1.1	1.1	-	-
1.5	155	0.65	0.61	0.236	1.5	1.5	1.5	1.4	-	-
2.2	225	0.65	0.61	0.236	1.6	1.6	1.6	-	-	-
2.7	275	0.65	0.61	0.236	1.9	1.9	1.9	-	-	-
3.3	335	0.65	0.61	0.236	2.4	2.4	2.4	-	--	-
4.7	475	0.65	0.61	0.236	2.6	2.6	-	-	-	-
5.6	565	0.65	0.61	0.236	3.1	3.1	-	-	-	-
6.8	685	0.65	0.61	0.236	1.9	-	-	-	-	-
8.2	825	0.65	0.61	0.236	2.3	-	-	-	-	-
10	106	0.65	0.61	0.236	2.9	-	-	-	-	-
12	126	0.65	0.61	0.236	3.4	-	-	-	-	-
0.56	564	0.65	0.61	0.315	1.9	1.9	1.9	1.9	1.9	1.9
0.68	684	0.65	0.61	0.315	2.3	2.3	2.3	2.3	2.3	2.3
1.2	125	0.65	0.61	0.315	1.8	1.8	1.8	1.8	1.8	-
1.5	155	0.65	0.61	0.315	2.3	2.3	2.3	2.3	2.3	-
1.8	185	0.65	0.61	0.315	1.7	1.7	1.7	1.7	-	-
2.2	225	0.65	0.61	0.315	2.1	2.1	2.1	2.1	-	-
3.9	395	0.65	0.61	0.315	2.8	2.8	2.8	-	-	-
4.7	475	0.65	0.61	0.315	3.4	3.4	3.4	-	-	-
6.8	685	0.65	0.61	0.315	3.7	3.7	-	-	-	-
8.2	825	0.65	0.61	0.315	4.5	4.5	-	-	-	-
15	156	0.65	0.61	0.315	4.3	-	-	-	-	-
18	186	0.65	0.61	0.315	5.2	-	-	-	-	-
0.82	824	0.65	0.61	0.394	2.8	2.8	2.8	2.8	2.8	2.8
1.8	185	0.65	0.61	0.394	2.7	2.7	2.7	2.7	2.7	-
2.2	225	0.65	0.61	0.394	3.4	3.4	3.4	3.4	3.4	-
2.7	275	0.65	0.61	0.394	2.6	2.6	2.6	2.6	-	-
3.3	335	0.65	0.61	0.394	3.2	3.2	3.2	3.2	-	-
5.6	565	0.65	0.61	0.394	4	4	4	-	-	-
10	106	0.65	0.61	0.394	5.5	5.5	-	-	-	-
22	226	0.65	0.61	0.394	6.3	-	-	-	-	-
1	105	0.65	0.61	0.473	3.4	3.4	3.4	3.4	3.4	3.4
2.7	275	0.65	0.61	0.473	4.1	4.1	4.1	4.1	4.1	-
3.9	395	0.65	0.61	0.473	3.8	3.8	3.8	3.8	-	-
1	105	0.65	0.61	0.473	3.4	3.4	3.4	3.4	3.4	3.4
2.7	275	0.65	0.61	0.473	4.1	4.1	4.1	4.1	4.1	-
3.9	395	0.65	0.61	0.473	3.8	3.8	3.8	3.8	-	-
6.8	685	0.65	0.61	0.473	4.9	4.9	4.9	-	-	-
27	276	0.65	0.61	0.473	7.8	-	-	-	-	-
1.2	125	0.65	0.61	0.551	4	4	4	4	4	4
3.3	335	0.65	0.61	0.551	3.3	3.3	3.3	3.3	5	-
4.7	475	0.65	0.61	0.551	4.6	4.6	4.6	4.6	-	-
8.2	825	0.65	0.61	0.551	5.9	5.9	5.9	-	-	-
15	156	0.65	0.61	0.551	8.3	8.3	-	-	-	-
33	336	0.65	0.61	0.551	9.5	-	-	-	-	-
10	106	0.65	0.61	0.67	7.2	7.2	7.2	-	-	-

RMS current rated at 300kHz up to 105°C.

CAPACITORS FOR HIGH FREQUENCY SWITCH MODE POWER SUPPLIES

TYPE DPM 94 / DPM 94N

STANDARD RATINGS

TYPE DPM 94-4 / DPM 94-N-4										
Capacitance		Dimensions (in inches)			50 V	63 V	100 V	200 V	250 V	400 V
µF	Code	Max. "L"	Max. "E"	Max. "H"	(l. rms)	(l. rms)	(l. rms)	(l. rms)	(l. rms)	(l. rms)
0.47	474	0.728	0.67	0.236	1.3	1.3	1.3	1.3	1.3	1.3
0.56	564	0.728	0.67	0.236	1.6	1.6	1.6	1.6	1.6	1.6
0.68	684	0.728	0.67	0.236	2	2	2	2	2	2
1	105	0.728	0.67	0.236	1.3	1.3	1.3	1.3	1.3	-
1.2	125	0.728	0.67	0.236	1.6	1.6	1.6	1.6	1.6	-
1.5	155	0.728	0.67	0.236	2	2	2	2	2	-
1.8	185	0.728	0.67	0.236	1.6	1.6	1.6	1.6	--	-
2.2	225	0.728	0.67	0.236	2	2	2	2	-	-
3.3	335	0.728	0.67	0.236	2.1	2.1	2.1	-	-	-
3.9	395	0.728	0.67	0.236	2.5	2.5	2.5	-	-	-
6.8	685	0.728	0.67	0.236	3.4	3.4	-	-	-	-
10	106	0.728	0.67	0.236	2.6	-	-	-	-	-
12	126	0.728	0.67	0.236	3.1	-	-	-	-	-
15	156	0.728	0.67	0.236	3.9	-	-	-	-	-
0.82	824	0.728	0.67	0.315	2.5	2.5	2.5	2.5	2.5	2.5
1.8	185	0.728	0.67	0.315	2.4	2.4	2.4	2.4	2.4	-
2.2	225	0.728	0.67	0.315	3	3	3	3	3	-
2.7	275	0.728	0.67	0.315	2.4	2.4	2.4	2.4	-	-
4.7	475	0.728	0.67	0.315	3	3	3	-	-	-
5.6	565	0.728	0.67	0.315	3.6	3.6	3.6	-	-	-
8.2	825	0.728	0.67	0.315	4	4	-	-	-	-
10	106	0.728	0.67	0.315	4.9	4.9	-	-	-	-
18	186	0.728	0.67	0.315	4.6	-	-	-	-	-
22	226	0.728	0.67	0.315	5.7	-	-	-	-	-
1	104	0.728	0.67	0.394	3	3	3	3	3	3
1.2	125	0.728	0.67	0.394	3.6	3.6	3.6	3.6	3.6	3.6
2.7	275	0.728	0.67	0.394	3.6	3.6	3.6	3.6	3.6	-
3.3	335	0.728	0.67	0.394	3	3	3	3	4.4	-
3.9	395	0.728	0.67	0.394	3.5	3.5	3.5	3.5	-	-
6.8	685	0.728	0.67	0.394	4.3	4.3	4.3	-	-	-
8.2	825	0.728	0.67	0.394	5.2	5.2	5.2	-	-	-
12	126	0.728	0.67	0.394	5.9	5.9	-	-	-	-
27	276	0.728	0.67	0.394	7	-	-	-	-	-
1.5	155	0.728	0.67	0.473	4.5	4.5	4.5	4.5	4.5	4.5
3.9	395	0.728	0.67	0.473	5.3	5.3	5.3	5.3	5.3	-
4.7	475	0.728	0.67	0.473	4.3	4.3	4.3	4.3	-	-
10	106	0.728	0.67	0.473	6.4	6.4	6.4	-	-	-
15	156	0.728	0.67	0.473	7.4	7.4	-	-	-	-
33	336	0.728	0.67	0.473	8.5	-	-	-	-	-
1.8	185	0.728	0.67	0.591	5.4	5.4	5.4	5.4	5.4	5.4
4.7	475	0.728	0.67	0.591	6.3	6.3	6.3	6.3	6.3	-
5.6	565	0.728	0.67	0.591	5.1	5.1	5.1	5.1	-	-
12	126	0.728	0.67	0.591	7.7	7.7	7.7	-	-	-
18	186	0.728	0.67	0.591	8.9	8.9	-	-	-	-
22	226	0.728	0.67	0.591	10	10	-	-	-	-
39	396	0.728	0.67	0.591	10	-	-	-	-	-
47	476	0.728	0.67	0.591	10	-	-	-	-	-
6.8	685	0.728	0.67	0.67	-	-	-	6.2	-	-

RMS current rated at 300kHz up to 105°C.

CAPACITORS FOR HIGH FREQUENCY SWITCH MODE POWER SUPPLIES



PHYSICAL CHARACTERISTICS

CONSTRUCTION:

Dielectric: metallized polyethylene terephthalate. Self healing, low inductance.

CASE:

Thermoplastic case. Epoxy resin molded.

LEAD MATERIAL:

DPM 948 - Surface mount device.

MARKING:

Dearborn trademark, type or catalog number, capacitance, tolerance and voltage.

ELECTRICAL SPECIFICATIONS

OPERATING TEMPERATURE RANGE:

-55°C to +105°C

DISSIPATION FACTOR:

$\leq 0.8\%$ @ 1kHz $C_R \leq 1 \mu\text{F}$

$\leq 1.0\%$ @ 1kHz $C_R > 1 \mu\text{F}$

INSULATION RESISTANCE:

$\geq 3,750 \text{ M}\Omega$ for $C_R \leq 0.33$ and $\leq 100 \text{ V}$

$\geq 7,500 \text{ M}\Omega$ for $C_R \leq 0.33$ and $\leq 100 \text{ V}$

DIELECTRIC WITHSTANDING VOLTAGE (DWW):

1.6 x rated voltage

PERMISSIBLE CURRENT:

@ 300kHz up to 105°C = I_{rms}

@ 300kHz to 125°C = $0.1 I_{\text{rms}}$

AVAILABLE CAPACITANCE TOLERANCES:

$\pm 20\%$ & $\pm 10\%$

VOLTAGE GRADIENTS (dV / dT in V / s)

Model	63 V	100 V	160 V	250 V	400 V	500 V	630 V
DPM 948-1	70	80	130	150	230	370	440
DPM 948-2	40	40	60	70	100	130	170
DPM 948-3	30	40	50	70	100	130	160
DPM 948-4	30	30	50	60	90	120	140

DIMENSIONS (in inches)

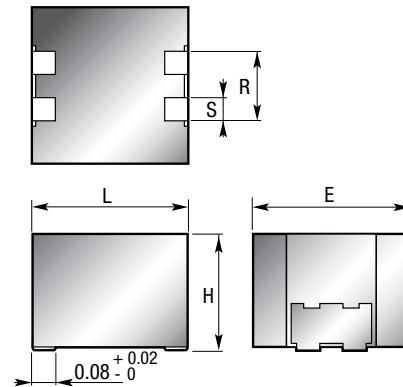

CAPACITORS FOR HIGH FREQUENCY SWITCH MODE POWER SUPPLIES

TYPE DPM 948

STANDARD RATINGS

Capacitance		Dimensions (in inches)					TYPE DPM 948-1						
μF	Code	Max. "L"	Max. "E"	Max. "H"	R ± 0.008	S ± 0.008	63 V (l. rms)	100 V (l. rms)	160 V (l. rms)	250 V (l. rms)	400 V (l. rms)	500 V (l. rms)	630 V (l. rms)
0.022	223	0.421	0.421	0.236	0.197	0.06	0.2	0.2	0.2	0.2	0.2	0.2	0.2
0.027	273	0.421	0.421	0.236	0.197	0.06	0.2	0.2	0.2	0.2	0.2	0.2	0.2
0.033	333	0.421	0.421	0.236	0.197	0.06	0.2	0.2	0.2	0.2	0.2	0.2	0.3
0.039	393	0.421	0.421	0.236	0.197	0.06	0.3	0.3	0.3	0.3	0.3	0.3	0.4
0.047	473	0.421	0.421	0.236	0.197	0.06	0.4	0.4	0.4	0.4	0.4	0.4	-
0.056	563	0.421	0.421	0.236	0.197	0.06	0.4	0.4	0.4	0.4	0.4	0.4	-
0.068	683	0.421	0.421	0.236	0.197	0.06	0.4	0.4	0.4	0.4	0.4	0.5	-
0.082	823	0.421	0.421	0.236	0.197	0.06	0.5	0.5	0.5	0.5	0.5	-	-
0.1	104	0.421	0.421	0.236	0.197	0.06	0.6	0.6	0.6	0.6	0.6	-	-
0.12	124	0.421	0.421	0.236	0.197	0.06	0.7	0.7	0.7	0.7	0.7	-	-
0.15	154	0.421	0.421	0.236	0.197	0.06	0.9	0.9	0.9	0.9	0.9	-	-
0.18	184	0.421	0.421	0.236	0.197	0.06	0.3	0.3	0.3	0.3	-	-	-
0.22	224	0.421	0.421	0.236	0.197	0.06	0.4	0.4	0.4	0.4	-	-	-
0.27	274	0.421	0.421	0.236	0.197	0.06	0.5	0.5	0.5	0.5	-	-	-
0.33	334	0.421	0.421	0.236	0.197	0.06	0.5	0.5	0.5	0.6	-	-	-
0.39	394	0.421	0.421	0.236	0.197	0.06	0.6	0.6	0.6	-	-	-	-
0.47	474	0.421	0.421	0.236	0.197	0.06	0.7	0.7	0.7	-	-	-	-
0.56	564	0.421	0.421	0.236	0.197	0.06	0.7	0.7	0.8	-	-	-	-
0.68	684	0.421	0.421	0.236	0.197	0.06	0.8	0.8	-	-	-	-	-
0.82	824	0.421	0.421	0.236	0.197	0.06	0.9	0.9	-	-	-	-	-
1	105	0.421	0.421	0.236	0.197	0.06	1.1	1.2	-	-	-	-	-
1.2	125	0.421	0.421	0.236	0.197	0.06	1.3	-	-	-	-	-	-
1.5	155	0.421	0.421	0.236	0.197	0.06	1.7	-	-	-	-	-	-
1.8	185	0.421	0.421	0.236	0.197	0.06	2.1	-	-	-	-	-	-
0.047	473	0.421	0.421	0.315	0.197	0.06	0.5	0.5	0.5	0.5	0.5	0.5	0.5
0.056	563	0.421	0.421	0.315	0.197	0.06	0.6	0.6	0.6	0.6	0.6	0.6	0.6
0.082	823	0.421	0.421	0.315	0.197	0.06	0.7	0.7	0.7	0.7	0.7	0.7	-
0.1	104	0.421	0.421	0.315	0.197	0.06	0.8	0.8	0.8	0.8	0.8	0.8	-
0.18	184	0.421	0.421	0.315	0.197	0.06	1	1	1	1	1	-	-
0.22	224	0.421	0.421	0.315	0.197	0.06	1.3	1.3	1.3	1.3	1.3	-	-
0.39	394	0.421	0.421	0.315	0.197	0.06	0.8	0.8	0.8	0.8	-	-	-
0.47	474	0.421	0.421	0.315	0.197	0.06	1	1	1	1	-	-	-
0.68	684	0.421	0.421	0.315	0.197	0.06	1	1	1	-	-	-	-
0.82	824	0.421	0.421	0.315	0.197	0.06	1.1	1.1	1.1	-	-	-	-
1.2	125	0.421	0.421	0.394	0.197	0.06	1.4	1.4	-	-	-	-	-
1.5	155	0.421	0.421	0.394	0.197	0.06	1.8	1.8	-	-	-	-	-
1.8	185	0.421	0.421	0.394	0.197	0.06	2.1	2.1	-	-	-	-	-
2.2	225	0.421	0.421	0.394	0.197	0.06	2.5	-	-	-	-	-	-
2.7	275	0.421	0.421	0.394	0.197	0.06	3.1	-	-	-	-	-	-

RMS current rated at 300kHz up to 105°C.

CAPACITORS FOR HIGH FREQUENCY SWITCH MODE POWER SUPPLIES

STANDARD RATINGS

Capacitance		Dimensions (in inches)					TYPE DPM 948-1							
μF	Code	Max. "L"	Max. "E"	Max. "H"	R ± 0.008	S ± 0.008	63 V (l. rms)	100 V (l. rms)	160 V (l. rms)	250 V (l. rms)	400 V (l. rms)	500 V (l. rms)	630 V (l. rms)	
0.068	683	0.421	0.421	0.394	0.197	0.06	0.7	0.7	0.7	0.7	0.7	0.7	0.7	
0.082	823	0.421	0.421	0.394	0.197	0.06	1	1	1	1	1	1	1	
0.1	104	0.421	0.421	0.394	0.197	0.06	1.1	1.1	1.1	1.1	1.1	1.1	1.1	
0.12	124	0.421	0.421	0.394	0.197	0.06	1	1	1	1	1	1	-	
0.15	154	0.421	0.421	0.394	0.197	0.06	1.2	1.2	1.2	1.2	1.2	1.2	-	
0.27	274	0.421	0.421	0.394	0.197	0.06	1.6	1.6	1.6	1.6	1.6	-	-	
0.56	564	0.421	0.421	0.394	0.197	0.06	1.1	1.1	1.1	1.1	-	-	-	
0.68	684	0.421	0.421	0.394	0.197	0.06	1.4	1.4	1.4	1.4	-	-	-	
1	105	0.421	0.421	0.394	0.197	0.06	1.4	1.4	1.4	-	-	-	-	
1.2	125	0.421	0.421	0.394	0.197	0.06	1.8	1.8	1.8	-	-	-	-	
2.2	225	0.421	0.421	0.394	0.197	0.06	2.6	2.6	-	-	-	-	-	
2.7	275	0.421	0.421	0.394	0.197	0.06	3.2	3.2	-	-	-	-	-	
3.3	335	0.421	0.421	0.394	0.197	0.06	3.8	-	-	-	-	-	-	
3.9	395	0.421	0.421	0.394	0.197	0.06	4.69	-	-	-	-	-	-	
0.12	124	0.421	0.421	0.475	0.197	0.06	1.3	1.3	1.3	1.3	1.3	1.3	1.3	
0.18	184	0.421	0.421	0.475	0.197	0.06	1.4	1.4	1.4	1.4	1.4	1.4	-	
0.33	334	0.421	0.421	0.475	0.197	0.06	2	2	2	2	2	-	-	
0.39	394	0.421	0.421	0.475	0.197	0.06	2.3	2.3	2.3	2.3	2.3	-	-	
0.82	824	0.421	0.421	0.475	0.197	0.06	1.7	1.7	1.7	1.7	-	-	-	
1	105	0.421	0.421	0.475	0.197	0.06	2.1	2.1	2.1	2.1	-	-	-	
1.5	155	0.421	0.421	0.475	0.197	0.06	2.1	2.1	2.1	-	-	-	-	
1.8	185	0.421	0.421	0.475	0.197	0.06	2.6	2.6	2.6	-	-	-	-	
3.3	335	0.421	0.421	0.475	0.197	0.06	3.9	3.9	-	-	-	-	-	
4.7	475	0.421	0.421	0.475	0.197	0.06	6	-	-	-	-	-	-	
5.6	565	0.421	0.421	0.475	0.197	0.06	7.1	-	-	-	-	-	-	

RMS current rated at 300kHz up to 105°C.

CAPACITORS FOR HIGH FREQUENCY SWITCH MODE POWER SUPPLIES

TYPE DPM 948

STANDARD RATINGS

Capacitance		Dimensions (in inches)					TYPE DPM 948-2						
μF	Code	Max. "L"	Max. "E"	Max. "H"	R ± 0.008	S ± 0.008	63 V (l. rms)	100 V (l. rms)	160 V (l. rms)	250 V (l. rms)	400 V (l. rms)	500 V (l. rms)	630 V (l. rms)
0.068	683	0.61	0.453	0.236	0.197	0.06	0.3	0.3	0.3	0.3	0.3	0.3	0.3
0.082	823	0.61	0.453	0.236	0.197	0.06	0.3	0.3	0.3	0.3	0.3	0.3	0.3
0.1	104	0.61	0.453	0.236	0.197	0.06	0.4	0.4	0.4	0.4	0.4	0.4	0.4
0.12	124	0.61	0.453	0.236	0.197	0.06	0.4	0.4	0.4	0.4	0.4	0.4	0.5
0.15	154	0.61	0.453	0.236	0.197	0.06	0.5	0.5	0.5	0.5	0.5	0.5	-
0.18	184	0.61	0.453	0.236	0.197	0.06	0.5	0.5	0.5	0.5	0.5	0.7	-
0.22	224	0.61	0.453	0.236	0.197	0.06	0.6	0.6	0.6	0.6	0.6	0.8	-
0.27	274	0.61	0.453	0.236	0.197	0.06	0.8	0.8	0.8	0.8	0.8	-	-
0.33	334	0.61	0.453	0.236	0.197	0.06	1	1	1	1	1	-	-
0.47	474	0.61	0.453	0.236	0.197	0.06	0.8	0.8	0.8	0.8	-	-	-
0.56	564	0.61	0.453	0.236	0.197	0.06	0.9	0.9	0.9	0.9	-	-	-
0.68	684	0.61	0.453	0.236	0.197	0.06	1.1	1.1	1.1	1.1	-	-	-
0.82	824	0.61	0.453	0.236	0.197	0.06	0.6	0.6	0.6	1.3	-	-	-
1	105	0.61	0.453	0.236	0.197	0.06	0.7	0.7	0.7	-	-	-	-
1.2	125	0.61	0.453	0.236	0.197	0.06	0.9	0.9	0.9	-	-	-	-
1.5	155	0.61	0.453	0.236	0.197	0.06	0.9	0.9	1.1	-	-	-	-
1.8	185	0.61	0.453	0.236	0.197	0.06	1.1	1.1	-	-	-	-	-
2.2	225	0.61	0.453	0.236	0.197	0.06	1.3	1.3	-	-	-	-	-
2.7	275	0.61	0.453	0.236	0.197	0.06	1.5	1.7	-	-	-	-	-
3.3	335	0.61	0.453	0.236	0.197	0.06	1.9	-	-	-	-	-	-
3.9	395	0.61	0.453	0.236	0.197	0.06	2.3	-	-	-	-	-	-
0.15	154	0.61	0.453	0.315	0.197	0.06	0.7	0.7	0.7	0.7	0.7	0.7	0.7
0.18	184	0.61	0.453	0.315	0.197	0.06	1	1	1	1	1	1	1
0.27	274	0.61	0.453	0.315	0.197	0.06	1	1	1	1	1	1	-
0.33	334	0.61	0.453	0.315	0.197	0.06	1.2	1.2	1.2	1.2	1.2	1.2	-
0.39	394	0.61	0.453	0.315	0.197	0.06	1.1	1.1	1.1	1.1	1.1	-	-
0.47	474	0.61	0.453	0.315	0.197	0.06	0.4	1.4	1.4	1.4	1.4	-	-
1	105	0.61	0.453	0.315	0.197	0.06	1.6	1.6	1.6	1.6	-	-	-
1.2	125	0.61	0.453	0.315	0.197	0.06	2	2	2	2	-	-	-
1.8	185	0.61	0.453	0.315	0.197	0.06	1.4	1.4	1.4	-	-	-	-
2.2	225	0.61	0.453	0.315	0.197	0.06	2.2	2.2	2.2	-	-	-	-
3.3	335	0.61	0.453	0.315	0.197	0.06	2	2	-	-	-	-	-
3.9	395	0.61	0.453	0.315	0.197	0.06	2.4	2.4	-	-	-	-	-
4.7	475	0.61	0.453	0.315	0.197	0.06	2.8	-	-	-	-	-	-
5.6	565	0.61	0.453	0.315	0.197	0.06	3.3	-	-	-	-	-	-
0.22	224	0.61	0.453	0.394	0.197	0.06	1.1	1.1	1.1	1.1	1.1	1.1	1.1
0.27	274	0.61	0.453	0.394	0.197	0.06	1.4	1.4	1.4	1.4	1.4	1.4	1.4
0.39	394	0.61	0.453	0.394	0.197	0.06	1.4	1.4	1.4	1.4	1.4	1.4	-
0.47	474	0.61	0.453	0.394	0.197	0.06	1.7	1.7	1.7	1.7	1.7	1.7	-
0.56	564	0.61	0.453	0.394	0.197	0.06	1.7	1.7	1.7	1.7	1.7	-	-
0.68	684	0.61	0.453	0.394	0.197	0.06	2	2	2	2	2	-	-
1.5	155	0.61	0.453	0.394	0.197	0.06	2.5	2.5	2.5	2.5	-	-	-
1.8	185	0.61	0.453	0.394	0.197	0.06	3	3	3	3	-	-	-
2.7	275	0.61	0.453	0.394	0.197	0.06	2.1	2.1	2.1	-	-	-	-
3.3	335	0.61	0.453	0.394	0.197	0.06	2.5	2.5	2.5	-	-	-	-
4.7	475	0.61	0.453	0.394	0.197	0.06	2.8	2.8	-	-	-	-	-
5.6	565	0.61	0.453	0.394	0.197	0.06	3.4	3.4	-	-	-	-	-
6.8	685	0.61	0.453	394	0.197	0.06	4	-	-	-	-	-	-
8.2	825	0.61	0.453	0.394	0.197	0.06	4.8	-	-	-	-	-	-

RMS current rated at 300kHz up to 105°C.

CAPACITORS FOR HIGH FREQUENCY SWITCH MODE POWER SUPPLIES

STANDARD RATINGS

Capacitance		Dimensions (in inches)					TYPE DPM 948-3						
μF	Code	Max. "L"	Max. "E"	Max. "H"	R ± 0.008	S ± 0.008	63 V (l. rms)	100 V (l. rms)	160 V (l. rms)	250 V (l. rms)	400 V (l. rms)	500 V (l. rms)	630 V (l. rms)
0.12	124	0.65	0.61	0.236	0.276	0.08	0.5	0.5	0.5	0.5	0.5	0.5	0.5
0.15	154	0.65	0.61	0.236	0.276	0.08	0.6	0.6	0.6	0.6	0.6	0.6	0.6
0.18	184	0.65	0.61	0.236	0.276	0.08	0.7	0.7	0.7	0.7	0.7	0.7	0.7
0.22	224	0.65	0.61	0.236	0.276	0.08	0.7	0.7	0.7	0.7	0.7	0.7	-
0.27	274	0.65	0.61	0.236	0.276	0.08	0.9	0.9	0.9	0.9	0.9	0.9	-
0.33	334	0.65	0.61	0.236	0.276	0.08	0.9	0.9	0.9	0.9	0.9	-	-
0.39	394	0.65	0.61	0.236	0.276	0.08	1	1	1	1	1	-	-
0.47	474	0.65	0.61	0.236	0.276	0.08	1.3	1.3	1.3	1.3	1.3	-	-
0.82	824	0.65	0.61	0.236	0.276	0.08	0.7	0.7	0.7	0.7	-	-	-
1	105	0.65	0.61	0.236	0.276	0.08	0.9	0.9	0.9	0.9	-	-	-
1.2	125	0.65	0.61	0.236	0.276	0.08	1.1	1.1	1.1	1.1	-	-	-
1.5	155	0.65	0.61	0.236	0.276	0.08	1	1	1	-	-	-	-
1.8	185	0.65	0.61	0.236	0.276	0.08	1.3	1.3	1.3	-	-	-	-
2.2	225	0.65	0.61	0.236	0.276	0.08	1.6	1.6	1.6	-	-	-	-
2.7	275	0.65	0.61	0.236	0.276	0.08	1.5	1.5	-	-	-	-	-
3.3	335	0.65	0.61	0.236	0.276	0.08	1.8	1.9	-	-	-	-	-
3.9	395	0.65	0.61	0.236	0.276	0.08	2.1	2.2	-	-	-	-	-
4.7	475	0.65	0.61	0.236	0.276	0.08	2.6	-	-	-	-	-	-
5.6	565	0.65	0.61	0.236	0.276	0.08	3.1	-	-	-	-	-	-
0.22	224	0.65	0.61	0.315	0.276	0.08	0.9	0.9	0.9	0.9	0.9	0.9	0.9
0.27	274	0.65	0.61	0.315	0.276	0.08	1.1	1.1	1.1	1.1	1.1	1.1	1.1
0.33	334	0.65	0.61	0.315	0.276	0.08	1.1	1.1	1.1	1.1	1.1	1.1	1.3
0.39	394	0.65	0.61	0.315	0.276	0.08	1.3	1.3	1.3	1.3	1.3	1.3	-
0.47	474	0.65	0.61	0.315	0.276	0.08	1.6	1.6	1.6	1.6	1.6	1.6	-
0.56	564	0.65	0.61	0.315	0.276	0.08	1.5	1.5	1.5	1.5	1.5	-	-
0.68	684	0.65	0.61	0.315	0.276	0.08	1.8	1.8	1.8	1.8	1.8	-	-
0.82	824	0.65	0.61	0.315	0.276	0.08	2.2	2.2	2.2	2.2	2.2	-	-
1.5	155	0.65	0.61	0.315	0.276	0.08	1.4	1.4	1.4	1.4	-	-	-
1.8	185	0.65	0.61	0.315	0.276	0.08	1.7	1.7	1.7	1.7	-	-	-
2.2	225	0.65	0.61	0.315	0.276	0.08	2.1	2.1	2.1	2.1	-	-	-
2.7	275	0.65	0.61	0.315	0.276	0.08	1.9	1.9	1.9	-	-	-	-
3.3	335	0.65	0.61	0.315	0.276	0.08	2.4	2.4	2.4	-	-	-	-
4.7	475	0.65	0.61	0.315	0.276	0.08	2.7	2.7	-	-	-	-	-
5.6	565	0.65	0.61	0.315	0.276	0.08	3.2	3.2	-	-	-	-	-
6.8	685	0.65	0.61	0.315	0.276	0.08	3.7	-	-	-	-	-	-
8.2	825	0.65	0.61	0.315	0.276	0.08	4.5	-	-	-	-	-	-
0.39	394	0.65	0.61	0.394	0.276	0.08	1.6	1.6	1.6	1.6	1.6	1.6	1.6
0.56	564	0.65	0.61	0.394	0.276	0.08	1.9	1.9	1.9	1.9	1.9	1.9	-
0.68	684	0.65	0.61	0.394	0.276	0.08	2.3	2.3	2.3	2.3	2.3	2.3	-
1	105	0.65	0.61	0.394	0.276	0.08	2.7	2.7	2.7	2.7	2.7	-	-
1.2	125	0.65	0.61	0.394	0.276	0.08	3.2	3.2	3.2	3.2	3.2	-	-
2.7	275	0.65	0.61	0.394	0.276	0.08	2.6	2.6	2.6	2.6	-	-	-
3.9	395	0.65	0.61	0.394	0.276	0.08	2.8	2.8	2.8	-	-	-	-
4.7	475	0.65	0.61	0.394	0.276	0.08	3.4	3.4	3.4	-	-	-	-
6.8	685	0.65	0.61	0.394	0.276	0.08	3.2	3.2	-	-	-	-	-
8.2	825	0.65	0.61	0.394	0.276	0.08	4.7	4.7	-	-	-	-	-
10	106	0.65	0.61	0.394	0.276	0.08	5.5	-	-	-	-	-	-
12	126	0.65	0.61	0.394	0.276	0.08	6.6	-	-	-	-	-	-

RMS current rated at 300kHz up to 105°C.

CAPACITORS FOR HIGH FREQUENCY SWITCH MODE POWER SUPPLIES

TYPE DPM 948

STANDARD RATINGS

Capacitance		Dimensions (in inches)					TYPE DPM 948-3						
μF	Code	Max. "L"	Max. "E"	Max. "H"	R ± 0.008	S ± 0.008	63 V (l. rms)	100 V (l. rms)	160 V (l. rms)	250 V (l. rms)	400 V (l. rms)	500 V (l. rms)	630 V (l. rms)
0.47	474	0.65	0.61	0.473	0.276	0.08	2	2	2	2	2	2	2
0.56	564	0.65	0.61	0.473	0.276	0.08	2.4	2.4	2.4	2.4	2.4	2.4	2.4
0.82	824	0.65	0.61	0.473	0.276	0.08	2.8	2.8	2.8	2.8	2.8	2.8	-
3.3	335	0.65	0.61	0.473	0.276	0.08	3.2	3.2	3.2	3.2	-	-	-
5.6	565	0.65	0.61	0.473	0.276	0.08	4	4	4	-	-	-	-
10	106	0.65	0.61	0.473	0.276	0.08	5.7	5.7	-	-	-	-	-
15	156	0.65	0.61	0.473	0.276	0.08	8.3	-	-	-	-	-	-
1	106	0.65	0.61	0.551	0.276	0.08	3.4	3.4	3.4	3.4	3.4	3.4	-
1.5	155	0.65	0.61	0.551	0.276	0.08	4	4	4	4	4	-	-
1.8	185	0.65	0.61	0.551	0.276	0.08	4.8	4.8	4.8	4.8	4.8	-	-
3.9	395	0.65	0.61	0.551	0.276	0.08	3.8	3.8	3.8	3.8	-	-	-
6.8	685	0.65	0.61	0.551	0.276	0.08	4.9	4.9	4.9	-	-	-	-
12	126	0.65	0.61	0.551	0.276	0.08	6.8	6.8	-	-	-	-	-
18	186	0.65	0.61	0.551	0.276	0.08	9.9	-	-	-	-	-	-
0.68	684	0.65	0.61	0.67	0.276	0.059	2.9	2.9	2.9	2.9	2.9	2.9	2.9
1.2	125	0.65	0.61	0.67	0.276	0.08	4	4	4	4	4	4	-
2.2	225	0.65	0.61	0.67	0.276	0.08	5.9	5.9	5.9	5.9	5.9	-	-
4.7	475	0.65	0.61	0.67	0.276	0.08	4.6	4.6	4.6	4.6	-	-	-
8.2	825	0.65	0.61	0.67	0.276	0.08	5.9	5.9	5.9	-	-	-	-
15	156	0.65	0.61	0.67	0.276	0.08	8.5	8.5	-	-	-	-	-
22	226	0.65	0.61	0.67	0.276	0.08	12.1	-	-	-	-	-	-

RMS current rated at 300kHz up to 105°C.

CAPACITORS FOR HIGH FREQUENCY SWITCH MODE POWER SUPPLIES

STANDARD RATINGS

Capacitance		Dimensions (in inches)					TYPE DPM 948-4						
μF	Code	Max. "L"	Max. "E"	Max. "H"	R ± 0.008	S ± 0.008	63 V (l. rms)	100 V (l. rms)	160 V (l. rms)	250 V (l. rms)	400 V (l. rms)	500 V (l. rms)	630 V (l. rms)
0.18	184	0.728	0.67	0.236	0.276	0.08	0.6	0.6	0.6	0.6	0.6	0.6	0.6
0.22	224	0.728	0.67	0.236	0.276	0.08	0.7	0.7	0.7	0.7	0.7	0.7	0.7
0.27	274	0.728	0.67	0.236	0.276	0.08	0.7	0.7	0.7	0.7	0.7	0.7	-
0.33	334	0.728	0.67	0.236	0.276	0.08	0.9	0.9	0.9	0.9	0.9	0.9	-
0.39	394	0.728	0.67	0.236	0.276	0.08	1.1	1.1	1.1	1.1	1.1	1.1	-
0.47	474	0.728	0.67	0.236	0.276	0.08	1	1	1	1	1	-	-
0.56	564	0.728	0.67	0.236	0.276	0.08	1.3	1.3	1.3	1.3	1.3	-	-
1.2	125	0.728	0.67	0.236	0.276	0.08	1	1	1	1	-	-	-
1.5	155	0.728	0.67	0.236	0.276	0.08	1.3	1.3	1.3	1.3	-	-	-
2.2	225	0.728	0.67	0.236	0.276	0.08	1.4	1.4	1.4	-	-	-	-
2.7	275	0.728	0.67	0.236	0.276	0.08	1.7	1.7	1.7	-	-	-	-
3.9	395	0.728	0.67	0.236	0.276	0.08	2	2	-	-	-	-	-
4.7	475	0.728	0.67	0.236	0.276	0.08	2.3	2.4	-	-	-	-	-
5.6	565	0.728	0.67	0.236	0.276	0.08	2.8	-	-	-	-	-	-
6.8	685	0.728	0.67	0.236	0.276	0.08	3.4	-	-	-	-	-	-
0.27	274	0.728	0.67	0.315	0.276	0.08	0.9	0.9	0.9	0.9	0.9	0.9	0.9
0.33	334	0.728	0.67	0.315	0.276	0.08	1.1	1.1	1.1	1.1	1.1	1.1	1.1
0.47	474	0.728	0.67	0.315	0.276	0.08	1.3	1.3	1.3	1.3	1.3	1.3	-
0.56	564	0.728	0.67	0.315	0.276	0.08	1.6	1.6	1.6	1.6	1.6	1.6	-
0.68	684	0.728	0.67	0.315	0.276	0.08	1.6	1.6	1.6	1.6	1.6	2	-
0.82	824	0.728	0.67	0.315	0.276	0.08	2	2	2	2	2	-	-
1.8	185	0.728	0.67	0.315	0.276	0.08	1.6	1.6	1.6	1.6	-	-	-
2.2	225	0.728	0.67	0.315	0.276	0.08	2	2	2	2	-	-	-
3.3	335	0.728	0.67	0.315	0.276	0.08	2.1	2.1	2.1	-	-	-	-
3.9	395	0.728	0.67	0.315	0.276	0.08	2.5	2.5	2.5	-	-	-	-
5.6	565	0.728	0.67	0.315	0.276	0.08	2.9	2.9	-	-	-	-	-
6.8	685	0.728	0.67	0.315	0.276	0.08	3.4	3.4	-	-	-	-	-
8.2	825	0.728	0.67	0.315	0.276	0.08	4	4.2	-	-	-	-	-
10	106	0.728	0.67	0.315	0.276	0.08	4.9	-	-	-	-	-	-
0.39	394	0.728	0.67	0.394	0.276	0.08	1.4	1.4	1.4	1.4	1.4	1.4	1.4
0.47	474	0.728	0.67	0.394	0.276	0.08	1.6	1.6	1.6	1.6	1.6	1.6	1.6
0.82	824	0.728	0.67	0.394	0.276	0.08	2.5	2.5	2.5	2.5	2.5	2.5	-
1	105	0.728	0.67	0.394	0.276	0.08	2.4	2.4	2.4	2.4	2.4	-	-
1.2	125	0.728	0.67	0.394	0.276	0.08	2.9	2.9	2.9	2.9	2.9	-	-
2.7	275	0.728	0.67	0.394	0.276	0.08	2.4	2.4	2.4	2.4	-	-	-
3.3	335	0.728	0.67	0.394	0.276	0.08	3	3	3	3	-	-	-
4.7	475	0.728	0.67	0.394	0.276	0.08	3	3	3	-	-	-	-
5.6	565	0.728	0.67	0.394	0.276	0.08	3.6	3.6	3.6	-	-	-	-
10	106	0.728	0.67	0.394	0.276	0.08	5.1	5.1	-	-	-	-	-
12	126	0.728	0.67	0.394	0.276	0.08	5.9	-	-	-	-	-	-
15	156	0.728	0.67	0.394	0.276	0.08	7.4	-	-	-	-	-	-

RMS current rated at 300kHz up to 105°C.

CAPACITORS FOR HIGH FREQUENCY SWITCH MODE POWER SUPPLIES

TYPE DPM 948

STANDARD RATINGS

Capacitance		Dimensions (in inches)					TYPE DPM 948-4						
μF	Code	Max. "L"	Max. "E"	Max. "H"	R ± 0.008	S ± 0.008	63 V (l. rms)	100 V (l. rms)	160 V (l. rms)	250 V (l. rms)	400 V (l. rms)	500 V (l. rms)	630 V (l. rms)
0.56	564	0.728	0.67	0.473	0.276	0.08	2	2	2	2	2	2	2
0.68	684	0.728	0.67	0.473	0.276	0.08	2.5	2.5	2.5	2.5	2.5	2.5	2.5
1	105	0.728	0.67	0.473	0.276	0.08	3	3	3	3	3	3	-
1.5	155	0.728	0.67	0.473	0.276	0.08	3.6	3.6	3.6	3.6	3.6	-	-
1.8	185	0.728	0.67	0.473	0.276	0.08	4.3	4.3	4.3	4.3	4.3	-	-
3.9	395	0.728	0.67	0.473	0.276	0.08	3.5	3.5	3.5	3.5	-	-	-
6.8	685	0.728	0.67	0.473	0.276	0.08	4.3	4.3	4.3	-	-	-	-
8.2	825	0.728	0.67	0.473	0.276	0.08	5.2	5.2	5.2	-	-	-	-
12	126	0.728	0.67	0.473	0.276	0.08	6.1	6.1	-	-	-	-	-
15	156	0.728	0.67	0.473	0.276	0.08	7.6	7.6	-	-	-	-	-
18	186	0.728	0.67	0.473	0.276	0.08	8.9	-	-	-	-	-	-
0.82	824	0.728	0.67	0.591	0.276	0.08	3.1	3.1	3.1	3.1	3.1	3.1	3.1
1	105	0.728	0.67	0.591	0.276	0.08	3.7	3.7	3.7	3.7	3.7	3.7	3.7
1.2	125	0.728	0.67	0.591	0.276	0.08	3.6	3.6	3.6	3.6	3.6	3.6	-
1.5	155	0.728	0.67	0.591	0.276	0.08	4.5	4.5	4.5	4.5	4.5	4.5	-
2.2	225	0.728	0.67	0.591	0.276	0.08	5.3	5.3	5.3	5.3	5.3	-	-
4.7	475	0.728	0.67	0.591	0.276	0.08	4.3	4.3	4.3	4.3	-	-	-
5.6	565	0.728	0.67	0.591	0.276	0.08	5.1	5.1	5.1	5.1	-	-	-
10	106	0.728	0.67	0.591	0.276	0.08	6.4	6.4	6.4	-	-	-	-
18	186	0.728	0.67	0.591	0.276	0.08	9.1	9.1	-	-	-	-	-
22	226	0.728	0.67	0.591	0.276	0.08	10	-	-	-	-	-	-
1.2	125	0.65	0.61	0.67	0.276	0.08	4.5	4.5	4.5	4.5	4.5	4.5	4.5
1.8	185	0.65	0.61	0.67	0.276	0.08	5.4	5.4	5.4	5.4	5.4	5.4	-
2.7	275	0.65	0.61	0.67	0.276	0.08	6.5	6.5	6.5	6.5	6.5	-	-
6.8	685	0.65	0.61	0.67	0.276	0.08	6.2	6.2	6.2	6.2	-	-	-
12	126	0.65	0.61	0.67	0.276	0.08	7.7	7.7	7.7	-	-	-	-
22	226	0.65	0.61	0.67	0.276	0.08	11.2	11.2	-	-	-	-	-
27	276	0.65	0.61	0.67	0.276	0.08	12.2	-	-	-	-	-	-

RMS current rated at 300kHz up to 105°C.

WRAP-AND-FILL POLYESTER DIELECTRIC FILM / FOIL CONSTRUCTION



FEATURES

- Extended Foil Construction
- Moisture Resistant

PHYSICAL CHARACTERISTICS

CONSTRUCTION:

Non-inductive wound polyester film and foil.

CASE: Flame retardant tape wrap and epoxy endfill.

LEAD MATERIAL: Solder coated solid wire.

LEAD WIRE SIZES:

Case Dia.	Lead AWG
≤ 0.437	0.025 (No. 22)
> 0.437	0.032 (No. 20)

LEAD STRENGTH:

Capable of withstanding a five pound pull force on lead axis.

MARKING:

Dearborn trademark, type or catalog number, capacitance, tolerance and voltage.

ELECTRICAL SPECIFICATIONS

CAPACITANCE RANGE: 0.001 μ F to 5.0 μ F

VOLTAGE RATING:

- 50 VDC to 600 VDC
- 32 VAC to 220 VAC

CAPACITANCE TOLERANCE: $\pm 20\%$, $\pm 10\%$, $\pm 5\%$

OPERATING TEMPERATURE: -55°C to $+125^{\circ}\text{C}$

DISSIPATION FACTOR: 1.0%, maximum

VOLTAGE DERATING:

- At $+105^{\circ}\text{C}$, 70% of the 85°C rating
- At $+125^{\circ}\text{C}$, 50% of the 85°C rating

VOLTAGE TEST: 200% of rated voltage for 1 minute

INSULATION RESISTANCE:

- At $+25^{\circ}\text{C}$, 50,000 Megaohm-Microfarads, need not exceed 100,000 Megaohms
- At $+85^{\circ}\text{C}$, 2,500 Megaohm-Microfarads, need not exceed 5,000 Megaohms
- At $+105^{\circ}\text{C}$, 1,000 Megaohm-Microfarads, need not exceed 2,000 Megaohms
- At $+125^{\circ}\text{C}$, 10 Megaohm-Microfarads, need not exceed 150 Megaohms

MAXIMUM PULSE RISE TIME

Capacitor Length (inch)	Rise Time dv / dt (V / μ s)				
	50 VDC	100 VDC	200 VDC	400 VDC	600 VDC
0.450	-	1000	-	-	-
0.531	735	-	-	-	-
0.594	540	-	-	-	-
0.656	360	-	-	-	-
0.718	288	288	413	875	1563
0.750	275	-	-	-	-
0.812	252	-	-	-	-
0.844	-	219	268	620	1050
0.875	-	-	-	-	1018
0.969	-	-	217	-	-
1.000	-	-	180	475	764
1.062	161	-	-	-	-
1.250	-	127	160	329	515
1.375	124	-	-	-	-
1.562	-	114	137	310	359
1.625	110	-	-	-	-
1.750	-	-	124	290	-
1.875	100	-	110	-	-
1.937	-	100	-	250	344
2.125	75	-	-	-	316
2.375	-	90	100	185	261
2.625	-	74	90	-	234
3.062	-	-	83	-	-

DIMENSIONS (in inches)

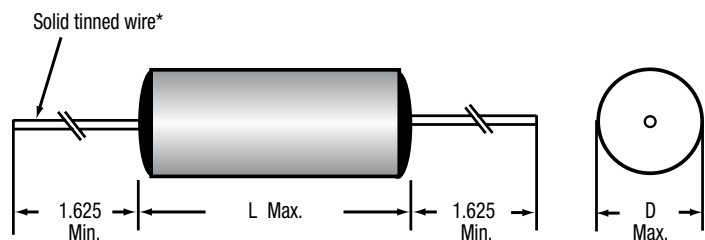

* Leads to be within $\pm 0.062''$ of center line at egress, but not less than 0.031" from edge.

WRAP-AND-FILL POLYESTER DIELECTRIC FILM / FOIL CONSTRUCTION

TYPE 410P

STANDARD RATINGS

Capacitance		Voltage Code 050 50 VDC / 32 VAC*		Voltage Code 100 100 VDC / 63 VAC*		Voltage Code 200 200 VDC / 126 VAC*		Voltage Code 400 400 VDC / 200 VAC*		Voltage Code 600 600 VDC / 220 VAC*	
μF	Code	D	L	D	L	D	L	D	L	D	L
0.0010	102	-	-	-	-	0.190	0.450	0.190	0.718	0.190	0.718
0.0015	152	-	-	-	-	0.190	0.450	0.190	0.718	0.190	0.718
0.0022	222	-	-	-	-	0.190	0.450	0.190	0.718	0.190	0.718
0.0033	332	-	-	-	-	0.190	0.450	0.190	0.718	0.205	0.718
0.0047	472	-	-	-	-	0.190	0.450	0.190	0.718	0.235	0.718
0.0068	682	-	-	0.190	0.450	0.190	0.718	0.190	0.718	0.240	0.844
0.010	103	-	-	0.190	0.450	0.190	0.718	0.200	0.844	0.270	0.844
0.015	153	0.190	0.531	0.190	0.718	0.190	0.718	0.230	0.844	0.315	0.875
0.022	223	0.200	0.594	0.190	0.718	0.190	0.718	0.265	0.844	0.375	0.875
0.033	333	0.210	0.656	0.190	0.718	0.190	0.844	0.315	0.875	0.395	1.000
0.047	413	0.215	0.718	0.215	0.718	0.210	0.844	0.325	1.000	0.400	1.250
0.068	683	0.250	0.718	0.215	0.844	0.240	0.844	0.340	1.250	0.455	1.250
0.10	104	0.290	0.750	0.245	0.844	0.275	0.969	0.400	1.250	0.470	1.562
0.15	154	0.312	0.812	0.285	0.844	0.345	1.000	0.405	1.562	0.545	1.562
0.22	224	0.315	1.062	0.290	1.250	0.355	1.250	0.480	1.562	0.590	1.937
0.33	334	0.375	1.062	0.325	1.250	0.425	1.250	0.650	1.750	0.800	1.937
0.47	474	0.430	1.062	0.380	1.250	0.440	1.562	0.725	1.937	0.890	2.125
0.68	689	0.450	1.375	0.455	1.562	0.610	1.750	0.750	2.375	0.980	2.375
1.00	105	0.500	1.375	0.535	1.562	0.710	1.875	0.900	2.375	-	-
1.50	155	0.640	1.625	0.645	1.937	0.730	2.375	-	-	-	-
2.00	205	0.730	1.625	0.715	1.937	0.800	2.375	-	-	-	-
2.50	255	0.750	1.875	0.715	2.375	0.834	2.625	-	-	-	-
3.00	305	0.830	1.875	0.770	2.375	0.905	2.625	-	-	-	-
4.00	405	0.850	2.125	0.830	2.625	0.945	3.062	-	-	-	-
5.00	505	0.940	2.125	0.915	2.625	-	-	-	-	-	-

Additional capacitance values, voltages, and tolerances are available upon request.

* AC voltage rating is at 60Hz 1.4 x VRMS + VDC should not exceed the rated VDC.

WRAP-AND-FILL HIGH CURRENT METALIZED POLYPROPYLENE FILM CAPACITORS



FEATURES

- AC voltage rating to 700 V
- DC voltage rating to 2,000 V
- High current
- High pulse operations

MAJOR APPLICATIONS:

Snubber and SCR commutating circuits, protection circuits, input and output filtering, blocking, timing and integrating circuits.

PHYSICAL CHARACTERISTICS

CONSTRUCTION:

Extended double-sided metalized polyester film, internal series connection (630 to 2,000 VDC), double-sided metalized polyester carrier film.

DIELECTRIC: Polypropylene film.

ELECTRODES: Vacuum deposited aluminum.

CASE: Flame retardant tape wrap and epoxy endfill.

LEAD MATERIAL: Solder coated copper wire.

LEAD WIRE SIZES:

Case Dia.	Lead AWG
< 0.300	No. 22
< 0.60	No. 20
0.650 and over	No. 18

LEAD PULL: 5 lbs (2.3 kg) for one minute. No physical damage.

LEAD BEND: After three complete consecutive bends. No damage.

MARKING:

Dearborn trademark, type or catalog number, capacitance, tolerance and voltage.

ELECTRICAL SPECIFICATIONS

CAPACITANCE RANGE: 0.001 μ F to 4.7 μ F

VOLTAGE RATING:

- 160 VDC to 2,000 VDC
- 100 VRMS to 700 VRMS

CAPACITANCE TOLERANCE: \pm 20%, \pm 10%, \pm 5%

OPERATING TEMPERATURE: -55°C to +105°C

VOLTAGE DERATING: At +105°C, 70% of the 85°C rating

DISSIPATION FACTOR: 0.03% maximum

DC VOLTAGE TEST: 160% of rated voltage for 10 sec.

INSULATION RESISTANCE:

Measure at 100 VDC after a 2 minute charge.

- At +25°C, 200,000 Megaohm-Microfarads, need not exceed 400,000 Megaohms

MAXIMUM PULSE RISE TIME

Capacitor Length (inch)	Rise Time dv / dt (V / μ s)						
	160 VDC	250 VDC	400 VDC	630 VDC	1,000 VDC	1,600 VDC	2,000 VDC
0.670	900	1140	1840	-	-	-	-
0.870	450	560	910	3430	-	-	-
1.140	260	320	520	2120	2800	3800	6200
1.340	202	240	400	1524	2000	2680	4200
1.750	140	170	280	980	1280	1690	2600

DIMENSIONS (in inches)

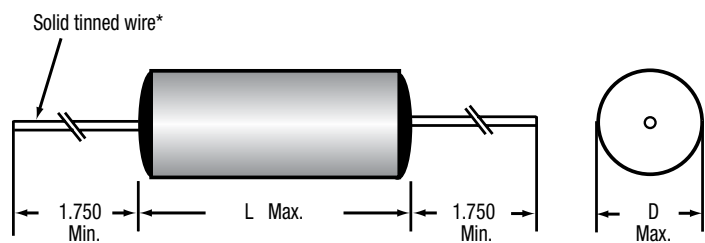

* Leads to be within \pm 0.062" of center line at egress, but not less than 0.031" from edge.

WRAP-AND-FILL HIGH CURRENT METALIZED POLYPROPYLENE FILM CAPACITORS

TYPE 709G

STANDARD RATINGS

Capacitance		Voltage Code 160 160 VDC / 100 VAC		Voltage Code 250 250 VDC / 160 VAC		Voltage Code 400 400 VDC / 200 VAC		Voltage Code 630 630 VDC / 400 VAC		Voltage Code 1K0 1,000 VDC / 600 VAC		Voltage Code 1K6 1,600 VDC / 650 VAC		Voltage Code 2K0 2,000 VDC / 700 VAC	
μF	Code	D	L	D	L	D	L	D	L	D	L	D	L	D	L
0.0010	102	-	-	-	-	-	-	-	-	-	-	-	-	0.256	1.142
0.0015	152	-	-	-	-	-	-	-	-	-	-	-	-	0.256	1.142
0.0022	222	-	-	-	-	-	-	-	-	-	-	-	-	0.256	1.142
0.0033	332	-	-	-	-	-	-	-	-	-	-	-	-	0.276	1.142
0.0047	472	-	-	-	-	-	-	-	-	-	-	-	-	0.315	1.142
0.0068	682	-	-	-	-	-	-	-	-	-	-	-	-	0.374	1.142
0.010	103	-	-	-	-	0.236	0.670	0.276	0.866	0.256	1.142	0.315	1.142	0.433	1.142
0.015	153	-	-	-	-	0.256	0.670	0.315	0.866	0.315	1.142	0.315	1.142	0.433	1.142
0.022	223	-	-	0.236	0.670	0.295	0.670	0.375	0.866	0.354	1.142	0.433	1.142	0.512	1.339
0.033	333	0.236	0.670	0.276	0.670	0.276	0.866	0.354	1.140	0.433	1.142	0.452	1.339	0.630	1.339
0.047	473	0.256	0.670	0.315	0.670	0.315	0.866	0.413	1.140	0.433	1.339	0.532	1.339	0.591	1.732
0.068	683	0.295	0.670	0.276	0.866	0.354	0.866	0.492	1.140	0.512	1.339	0.630	1.339	0.709	1.732
0.10	104	0.276	0.866	0.315	0.866	0.433	0.866	0.492	1.340	0.610	1.339	0.591	1.732	0.827	1.732
0.15	154	0.315	0.866	0.375	0.866	0.394	1.140	0.591	1.340	0.591	1.732	0.728	1.732	-	-
0.22	224	0.375	0.866	0.354	1.140	0.472	1.140	0.571	1.730	0.709	1.732	0.866	1.732	-	-
0.33	334	0.354	1.140	0.413	1.140	0.532	1.140	0.689	1.730	-	-	-	-	-	-
0.47	474	0.394	1.140	0.472	1.140	0.591	1.340	0.827	1.730	-	-	-	-	-	-
0.68	684	0.472	1.140	0.512	1.340	0.689	1.340	0.984	1.730	-	-	-	-	-	-
1.00	105	0.492	1.340	0.610	1.340	0.689	1.730	-	-	-	-	-	-	-	-
1.50	155	0.610	1.340	0.610	1.730	0.846	1.730	-	-	-	-	-	-	-	-
2.20	225	0.610	1.730	0.728	1.730	1.024	1.730	-	-	-	-	-	-	-	-
3.30	335	0.728	1.730	0.886	1.730	-	-	-	-	-	-	-	-	-	-
4.70	475	0.866	1.730	-	-	-	-	-	-	-	-	-	-	-	-

WRAP-AND-FILL HIGH CURRENT METALIZED POLYPROPYLENE FILM CAPACITORS

VOLTAGE VS. FREQUENCY TYPE 709G

160 VDC / 100 VAC

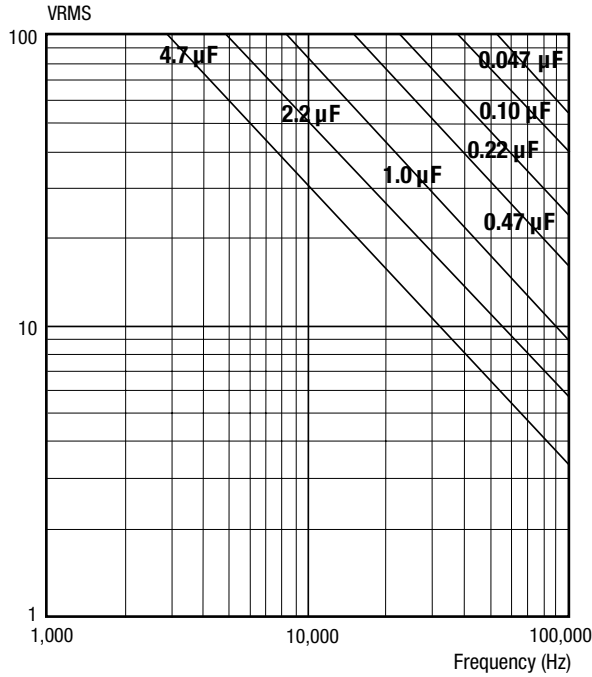

VOLTAGE VS. FREQUENCY TYPE 709G

250 VDC / 160 VAC

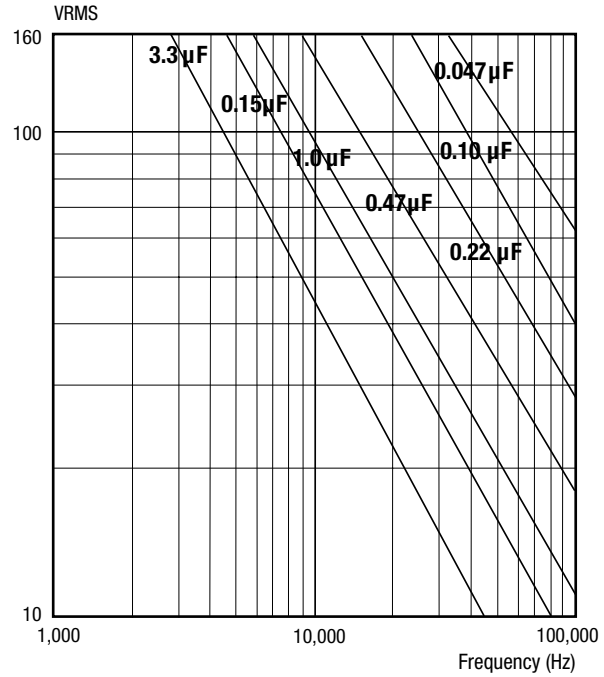

VOLTAGE VS. FREQUENCY TYPE 709G

400 VDC / 200 VAC

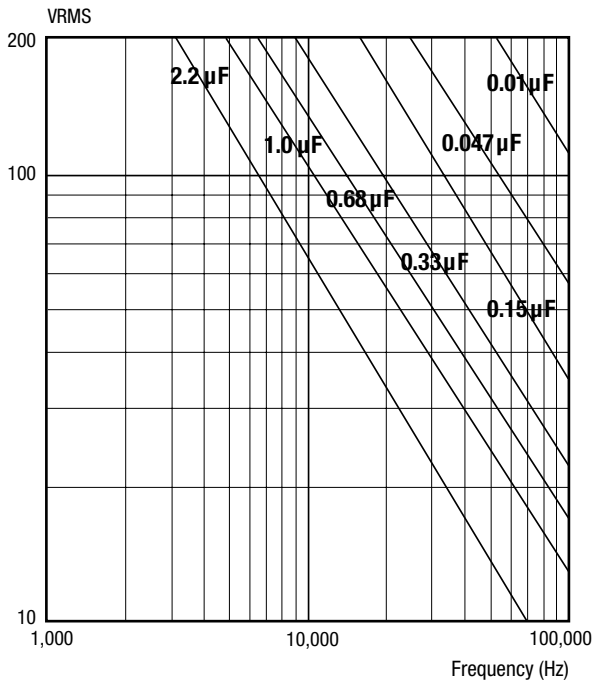

VOLTAGE VS. FREQUENCY TYPE 709G

630 VDC / 400 VAC

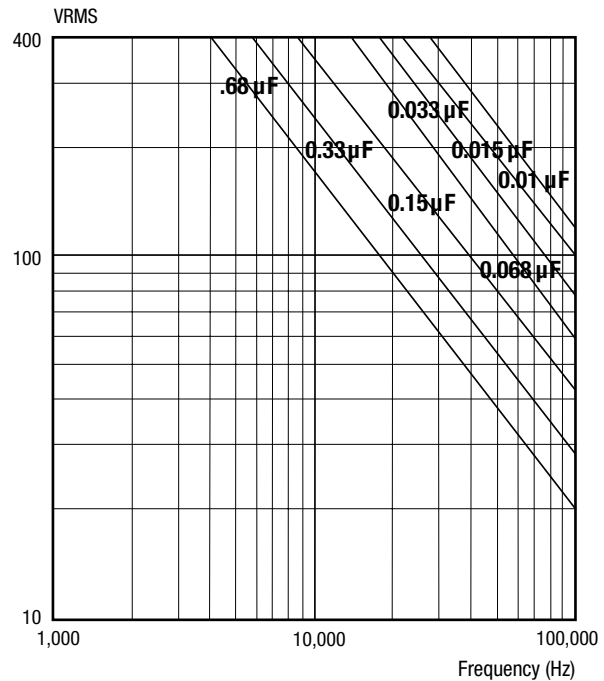

WRAP-AND-FILL HIGH CURRENT METALIZED POLYPROPYLENE FILM CAPACITORS

TYPE 709G

VOLTAGE VS. FREQUENCY TYPE 709G
1,000 VDC / 600 VAC

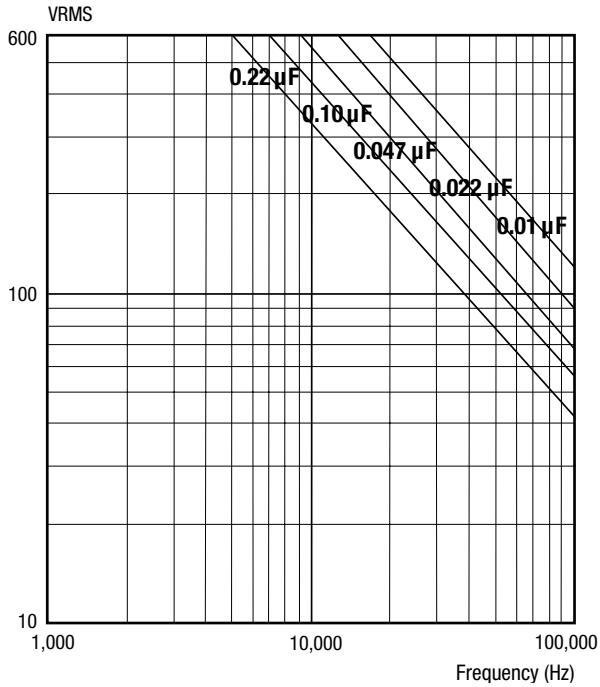

VOLTAGE VS. FREQUENCY TYPE 709G
1,600 VDC / 650 VAC

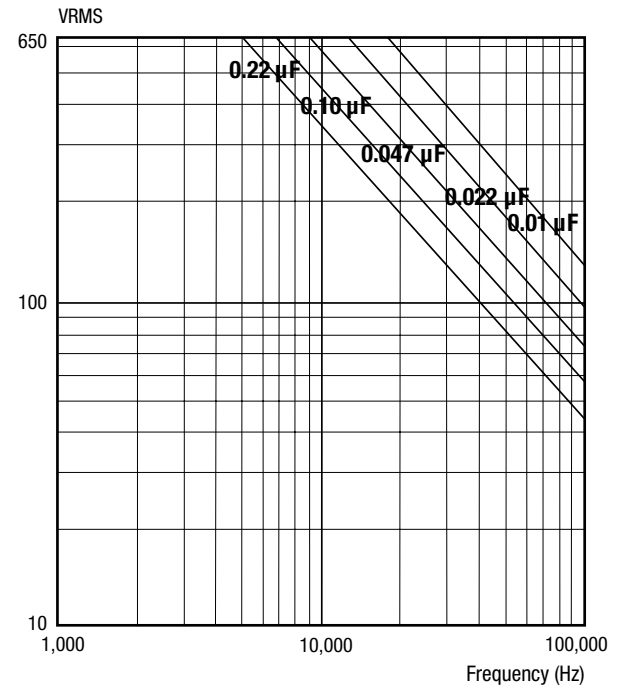

VOLTAGE VS. FREQUENCY TYPE 709G
2,000 VDC / 700 VAC

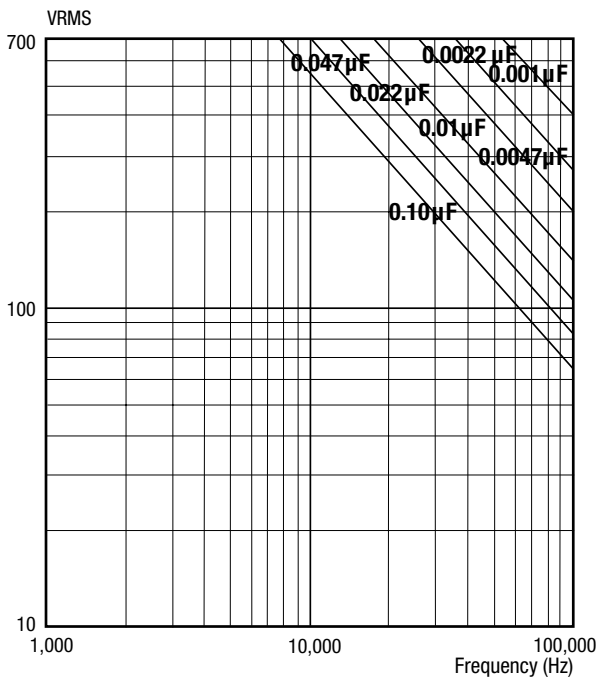

WRAP-AND-FILL HIGH-FREQUENCY METALIZED POLYPROPYLENE FILM CAPACITORS



FEATURES

- Excellent AC performance
- Low power dissipation
- Low dielectric absorption
- Close tolerance
- High stability
- Oval configuration affords economy of space

MAJOR APPLICATIONS:

Pulse operations, deflection-circuits, SMPS, high frequency coupling and decoupling, sample and hold circuits, timing, and other applications where low loss and high stability are important.

PHYSICAL CHARACTERISTICS

CONSTRUCTION: Non-inductive wound metalized polypropylene.

CASE: Flame retardant tape wrap and epoxy endfill.

LEAD MATERIAL: Solder coated copper wire.

LEAD WIRE SIZES:

Case Dia.	Lead AWG
< 0.350	No. 20
≥ 0.350	No. 18

LEAD STRENGTH: Capable of withstanding a five pound pull force on lead axis.

MARKING:

Dearborn trademark, type or catalog number, capacitance, tolerance and voltage.

ELECTRICAL SPECIFICATIONS

CAPACITANCE RANGE: 0.022 μ F to 10.0 μ F

VOLTAGE RATING:

- 160 VDC to 630 VDC
- 100 VRMS to 277 VRMS

CAPACITANCE TOLERANCE: $\pm 20\%$, $\pm 10\%$, $\pm 5\%$

OPERATING TEMPERATURE: -55°C to $+105^{\circ}\text{C}$

VOLTAGE DERATING: At $+105^{\circ}\text{C}$, 70% of the 85°C rating

DISSIPATION FACTOR: 0.07% maximum

EQUIVALENT SERIES RESISTANCE:

20kHz - 100kHz, see standard ratings tables

DC VOLTAGE TEST: 200% of rated voltage for 2 minutes

INSULATION RESISTANCE:

Measure at rated VDC after a 2 minute charge.

- At $+25^{\circ}\text{C}$, 200,000 Megaohm-Microfarads, need not exceed 400,000 Megaohms
- At $+85^{\circ}\text{C}$, 10,000 Megaohm-Microfarads, need not exceed 20,000 Megaohms
- At $+105^{\circ}\text{C}$, 1,000 Megaohm-Microfarads, need not exceed 2,000 Megaohms

MAXIMUM PULSE RISE TIME

Capacitor Length (inch)	Rise Time dv/dt (V / μ s)			
	160 VDC / 100 VAC	250 VDC / 175 VAC	400 VDC / 220 VAC	630 VDC / 277 VAC
0.75	48	72	94	171
1.00	28	40	55	88
1.25	22	30	45	62
1.75	12	18	23	38
2.25	-	13	-	-

DIMENSIONS (in inches)

TYPE 730P

0.032 nominal
Dia. (No. 20 AWG)
Solid tinned wire*

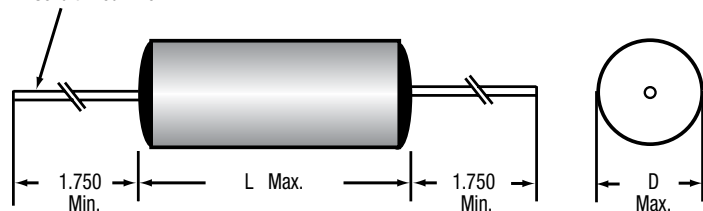

TYPE 731P

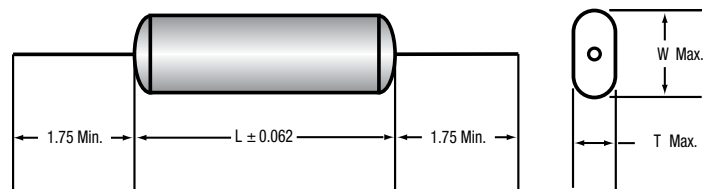

* Leads to be within ± 0.062 " of center line at egress, but not less than 0.031" from edge.

WRAP-AND-FILL HIGH-FREQUENCY METALIZED POLYPROPYLENE FILM CAPACITORS

TYPE 730P / 731P

STANDARD RATINGS

Capacitance		TYPE 730P		TYPE 731P			Typical ESR (Milliohms) 20kHz to 100kHz	Maximum Ripple Current (Amps) at 20-100kHz Case temperature						
μF	Code	D	L	T	W	L		+25°C	+35°C	+45°C	+55°C	+65°C	+75°C	+85°C
160 VDC / 100 VRMS* (VOLTAGE CODE 160)														
0.22	224	0.275	0.75	0.23	0.34	0.75	-	2.3	2.3	2.3	2.3	2.3	1.8	1.0
0.27	274	0.298	0.75	0.26	0.35	0.75	-	2.6	2.6	2.6	2.6	2.4	1.9	1.1
0.33	334	0.324	0.75	0.28	0.39	0.75	-	2.8	2.8	2.8	2.8	2.6	2.2	1.2
0.39	394	0.347	0.75	0.29	0.44	0.75	-	3.1	3.1	3.1	3.1	2.9	2.3	1.3
0.47	474	0.376	0.75	0.33	0.47	0.75	37	3.7	3.4	3.1	2.8	2.5	2.0	1.4
0.56	564	0.321	1.00	0.27	0.45	1.00	35	3.9	3.6	3.3	2.9	2.6	2.1	1.5
0.68	684	0.348	1.00	0.29	0.49	1.00	33	4.1	3.8	3.5	3.1	2.8	2.2	1.6
0.82	824	0.377	1.00	0.30	0.52	1.00	31	4.3	4.0	3.6	3.2	2.9	2.3	1.7
1.0	105	0.421	1.00	0.32	0.54	1.00	26	5.5	5.1	4.7	4.2	3.6	2.8	2.6
1.2	125	0.454	1.00	0.36	0.58	1.00	24	5.7	5.3	4.9	4.4	3.8	3.0	2.8
1.5	155	0.500	1.00	0.40	0.63	1.00	20	6.1	5.5	5.1	4.6	4.0	3.2	3.1
1.8	185	0.541	1.00	0.45	0.67	1.00	19	6.3	5.7	5.3	4.8	4.1	3.4	3.0
2.0	205	0.486	1.25	0.39	0.61	1.25	18	6.5	6.0	5.5	4.9	4.2	3.5	3.2
2.2	225	0.507	1.25	0.42	0.64	1.25	18	6.8	6.3	5.7	5.1	4.4	3.6	3.3
2.7	275	0.554	1.25	0.46	0.68	1.25	17	7.1	6.5	6.0	5.3	4.6	3.7	3.4
3.0	305	0.581	1.25	0.47	0.76	1.25	16	7.3	6.7	6.2	5.5	4.8	3.9	3.5
3.3	335	0.606	1.25	0.51	0.77	1.25	16	7.4	6.8	6.4	5.6	4.9	4.0	3.6
3.9	395	0.654	1.25	0.56	0.79	1.25	15	7.6	6.9	6.6	5.8	5.1	4.1	3.7
4.0	405	0.537	1.75	0.44	0.66	1.75	15	7.8	7.0	6.7	5.9	5.2	4.2	3.8
4.7	475	0.577	1.75	0.48	0.71	1.75	15	8.1	7.4	6.8	6.0	5.3	4.3	3.9
5.0	505	0.593	1.75	0.50	0.72	1.75	14	8.3	7.6	7.0	6.2	5.4	4.4	4.0
5.6	565	0.624	1.75	0.50	0.86	1.75	14	8.4	7.7	7.1	6.4	5.5	4.5	4.1
6.0	605	0.644	1.75	0.50	0.88	1.75	14	8.5	7.8	7.2	6.5	5.6	4.6	4.2
6.8	685	0.682	1.75	0.50	0.92	1.75	13	8.5	8.0	7.4	6.7	5.7	4.7	4.3
8.0	805	0.735	1.75	0.55	0.97	1.75	13	8.6	8.3	7.7	6.8	6.0	4.8	4.4
8.2	825	0.743	1.75	0.55	0.98	1.75	13	8.8	8.6	8.0	7.0	6.1	4.9	4.5
10.0	106	0.815	1.75	0.62	1.06	1.75	12	9.0	9.0	8.5	7.6	6.6	5.4	4.9
250 VDC / 175 VRMS* (VOLTAGE CODE 250)														
0.10	104	0.279	0.75	0.24	0.34	0.75	-	1.5	1.5	1.5	1.5	1.5	1.5	.09
0.12	124	0.300	0.75	0.26	0.37	0.75	-	1.9	1.9	1.9	1.9	1.9	1.7	1.0
0.15	154	0.327	0.75	0.27	0.42	0.75	-	2.3	2.3	2.3	2.3	2.3	1.9	1.1
0.18	184	0.353	0.75	0.28	0.48	0.75	-	2.7	2.7	2.7	2.7	2.5	2.0	1.2
0.22	224	0.306	1.00	0.25	0.39	1.00	-	1.9	1.9	1.9	1.9	1.9	1.9	1.3
0.27	274	0.333	1.00	0.28	0.42	1.00	-	2.4	2.4	2.4	2.4	2.4	2.2	1.4
0.33	334	0.362	1.00	0.31	0.45	1.00	-	2.9	2.9	2.9	2.9	2.9	2.3	1.5
0.39	394	0.389	1.00	0.33	0.48	1.00	-	3.4	3.4	3.4	3.2	2.9	2.3	1.6
0.47	474	0.422	1.00	0.34	0.55	1.00	35	3.8	3.7	3.6	3.4	2.9	2.4	1.7
0.56	564	0.464	1.00	0.37	0.58	1.00	33	3.9	3.8	3.7	3.5	3.1	2.5	1.8
0.68	684	0.425	1.25	0.34	0.55	1.25	32	4.0	3.9	3.8	3.7	3.2	2.6	1.9
0.82	824	0.471	1.25	0.37	0.59	1.25	31	4.2	4.1	4.0	3.9	3.4	2.8	2.0
1.0	105	0.513	1.25	0.38	0.69	1.25	28	4.4	4.4	4.4	4.4	4.3	3.5	3.2
1.2	125	0.554	1.25	0.41	0.73	1.25	27	4.7	4.6	4.5	5.0	4.5	3.7	3.3
1.5	155	0.613	1.25	0.43	0.85	1.25	26	5.1	5.0	4.9	5.4	4.7	3.9	3.5
1.8	185	0.667	1.25	0.48	0.90	1.25	25	5.9	5.8	5.7	5.7	5.0	4.1	3.7
2.0	205	0.700	1.25	0.49	0.99	1.25	21	7.2	7.2	6.8	6.0	5.2	4.3	3.9
2.2	225	0.610	1.75	0.41	0.82	1.75	20	8.4	7.5	7.0	6.3	5.4	4.5	4.1
2.7	275	0.669	1.75	0.46	0.88	1.75	19	8.6	7.8	7.3	6.6	5.7	4.7	4.3
3.0	305	0.703	1.75	0.49	0.91	1.75	18	9.0	8.3	7.6	6.8	5.9	4.8	4.4
3.3	335	0.734	1.75	0.50	1.00	1.75	18	9.0	8.4	7.8	7.0	6.0	4.9	4.5
3.9	395	0.794	1.75	0.53	1.06	1.75	17	9.0	8.5	8.0	7.2	6.2	5.0	4.6
4.0	405	0.803	1.75	0.54	1.07	1.75	16	9.0	8.6	8.2	7.4	6.3	5.1	4.7
4.7	475	0.866	1.75	0.60	1.13	1.75	16	9.0	8.8	8.5	7.7	6.6	5.3	4.9

Additional capacitance values, voltages, and tolerances are available upon request.

* AC voltage rating is at 400Hz 1.4 x VRMS + VDC should not exceed the rated VDC. * Graphs of AC voltage vs. frequency follow.

WRAP-AND-FILL HIGH-FREQUENCY METALIZED POLYPROPYLENE FILM CAPACITORS

STANDARD RATINGS

Capacitance		TYPE 730P		TYPE 731P			Typical ESR (Milliohms) 20kHz to 100kHz	Maximum Ripple Current (Amps) at 20-100kHz Case temperature						
µF	Code	Case Size (inches)		Case Size (inches)				+25°C	+35°C	+45°C	+55°C	+65°C	+75°C	+85°C
		D	L	T	W	L								
250 VDC (Cont.) (VOLTAGE CODE 250)														
2.0	205	0.700	1.25	0.49	0.99	1.25	21	6.5	6.5	6.5	6.5	6.0	4.9	3.5
2.2	225	0.610	1.75	0.41	0.82	1.75	20	7.8	7.8	7.8	7.8	7.2	5.9	4.2
2.7	275	0.669	1.75	0.46	0.88	1.75	19	8.0	8.0	8.0	8.0	7.4	6.0	4.3
3.0	305	0.703	1.75	0.49	0.91	1.75	18	8.4	8.4	8.4	8.4	7.8	6.4	4.5
3.6	335	0.734	1.75	0.50	1.00	1.75	18	7.8	7.8	7.8	7.8	7.3	5.9	4.2
3.9	395	0.794	1.75	0.53	1.06	1.75	17	7.9	7.9	7.9	7.9	7.3	5.9	4.2
4.0	405	0.803	1.75	0.54	1.07	1.75	16	8.2	8.2	8.2	8.2	7.6	6.2	4.4
4.7	475	0.866	1.75	0.60	1.13	1.75	16	7.9	7.9	7.9	7.9	7.3	6.0	4.2
5.0	505	0.892	1.75	0.62	1.15	1.75	15	9.0	9.0	8.8	7.9	6.8	5.6	5.1
5.6	565	0.941	1.75	0.67	1.20	1.75	15	9.0	9.0	8.9	8.0	7.0	5.8	5.3
6.0	605	0.972	1.75	0.70	1.23	1.75	15	9.0	9.0	9.0	8.2	7.2	5.9	5.5
6.8	685	0.882	2.25	0.66	1.09	2.25	15	9.0	9.0	9.0	8.4	7.4	6.0	5.6
8.0	805	0.953	2.25	0.73	1.17	2.25	14	9.0	9.0	9.0	8.7	7.8	6.3	5.8
8.2	825	0.964	2.25	0.74	1.23	2.25	14	9.0	9.0	9.0	8.8	7.9	6.4	5.9
10.0	106	1.060	2.25	0.78	1.32	2.25	13	9.0	9.0	9.0	9.0	8.3	6.8	6.2
400 VDC / 220 VRMS* (VOLTAGE CODE 400)														
0.047	473	0.258	0.75	0.22	0.32	0.75	-	1.0	1.0	1.0	1.0	1.0	1.0	0.9
0.056	563	0.275	0.75	0.24	0.34	0.75	-	1.1	1.1	1.1	1.1	1.1	1.1	0.9
0.068	683	0.297	0.75	0.25	0.39	0.75	-	1.4	1.4	1.4	1.4	1.4	1.4	1.0
0.082	823	0.320	0.75	0.27	0.4	0.75	-	1.7	1.7	1.7	1.7	1.7	1.6	1.1
0.10	104	0.348	0.75	0.27	0.48	0.75	-	2.0	2.0	2.0	2.0	2.0	1.9	1.3
0.12	124	0.299	1.00	0.25	0.39	1.00	-	1.4	1.4	1.4	1.4	1.4	1.4	1.4
0.15	154	0.328	1.00	0.28	0.42	1.00	-	1.7	1.7	1.7	1.7	1.7	1.7	1.6
0.18	184	0.353	1.00	0.29	0.48	1.00	-	2.1	2.1	2.1	2.1	2.1	2.1	1.7
0.22	224	0.385	1.00	0.30	0.52	1.00	-	2.6	2.6	2.6	2.6	2.6	2.5	1.8
0.27	274	0.421	1.00	0.30	0.61	1.00	-	3.1	3.1	3.1	3.1	3.1	2.7	1.9
0.33	334	0.469	1.00	0.33	0.65	1.00	-	3.8	3.8	3.8	3.8	3.5	2.9	2.0
0.39	394	0.503	1.00	0.37	0.69	1.00	-	4.1	4.1	4.1	4.1	3.7	3.1	2.1
0.47	474	0.545	1.00	0.41	0.73	1.00	32	5.7	5.5	5.0	4.4	3.8	3.2	2.2
0.56	564	0.506	1.25	0.37	0.69	1.25	31	5.7	5.7	5.3	4.4	4.1	3.3	2.3
0.68	684	0.551	1.25	0.38	0.79	1.25	30	5.7	5.7	5.5	4.8	4.3	3.5	2.4
0.82	824	0.599	1.25	0.42	0.84	1.25	28	5.7	5.7	5.6	5.3	4.5	3.7	2.6
1.0	105	0.655	1.25	0.47	0.90	1.25	27	5.7	5.7	5.7	5.7	5.7	4.7	4.3
1.2	125	0.712	1.25	0.53	0.95	1.25	26	6.3	6.2	6.0	5.9	5.8	4.9	4.5
1.5	155	0.658	1.75	0.45	0.88	1.75	25	7.0	6.9	6.7	6.6	6.5	5.2	4.7
1.8	185	0.716	1.75	0.51	0.93	1.75	23	8.0	7.9	7.8	7.7	6.8	5.5	5.0
2.0	205	0.752	1.75	0.54	0.97	1.75	21	9.0	9.0	9.0	8.0	7.0	5.7	5.2
2.2	225	0.786	1.75	0.55	1.06	1.75	20	9.0	9.0	9.0	8.3	7.4	5.9	5.4
2.7	275	0.865	1.75	0.60	1.13	1.75	19	9.0	9.0	9.0	8.6	7.6	6.0	5.6
3.0	305	0.909	1.75	0.64	1.17	1.75	17	9.0	9.0	9.0	9.0	7.9	6.4	5.9
3.3	335	0.951	1.75	0.68	1.22	1.75	16	9.0	9.0	9.0	9.0	8.1	6.6	6.3
3.9	395	1.031	1.75	0.75	1.29	1.75	15	9.0	9.0	9.0	9.0	8.3	6.8	6.5

Additional capacitance values, voltages, and tolerances are available upon request.

* AC voltage rating is at 400Hz 1.4 x VRMS + VDC should not exceed the rated VDC.

* Graphs of AC voltage vs. frequency follow.

WRAP-AND-FILL HIGH-FREQUENCY METALIZED POLYPROPYLENE FILM CAPACITORS

TYPE 730P / 731P

STANDARD RATINGS

Capacitance		TYPE 730P		TYPE 731P			Typical ESR (Milliohms) 20kHz to 100kHz	Maximum Ripple Current (Amps) at 20-100kHz Case temperature						
μF	Code	Case Size (inches)		Case Size (inches)				+25°C	+35°C	+45°C	+55°C	+65°C	+75°C	+85°C
630 VDC / 277 VRMS* (VOLTAGE CODE 630)														
0.022	223	0.283	0.75	0.25	0.35	0.75	-	0.8	0.8	0.8	0.8	0.8	0.8	0.8
0.027	273	0.307	0.75	0.26	0.40	0.75	-	1.0	1.0	1.0	1.0	1.0	1.0	0.9
0.033	333	0.334	0.75	0.27	0.43	0.75	-	1.2	1.2	1.2	1.2	1.2	1.2	1.0
0.039	393	0.358	0.75	0.28	0.49	0.75	-	1.4	1.4	1.4	1.4	1.4	1.4	1.0
0.047	473	0.388	0.75	0.29	0.58	0.75	-	1.7	1.7	1.7	1.7	1.7	1.6	1.1
0.056	563	0.418	0.75	0.30	0.61	0.75	-	2.1	2.1	2.1	2.1	2.1	1.7	1.2
0.068	683	0.346	1.00	0.27	0.48	1.00	-	1.3	1.3	1.3	1.3	1.3	1.3	1.3
0.082	823	0.374	1.00	0.29	0.51	1.00	-	1.6	1.6	1.6	1.6	1.6	1.6	1.4
0.10	104	0.408	1.00	0.31	0.56	1.00	-	1.9	1.9	1.9	1.9	1.9	1.9	1.6
0.12	124	0.443	1.00	0.32	0.63	1.00	-	2.3	2.3	2.3	2.3	2.3	2.3	1.8
0.15	154	0.496	1.00	0.36	0.68	1.00	-	2.9	2.9	2.9	2.9	2.9	2.6	1.9
0.18	184	0.538	1.00	0.40	0.72	1.00	-	3.5	3.5	3.5	3.5	3.5	2.7	1.9
0.22	224	0.496	1.25	0.36	0.68	1.25	-	2.8	2.8	2.8	2.8	2.8	2.8	2.3
0.27	274	0.542	1.25	0.40	0.72	1.25	-	3.5	3.5	3.5	3.5	3.5	3.3	2.3
0.33	334	0.593	1.25	0.41	0.83	1.25	-	4.3	4.3	4.3	4.3	4.3	3.5	2.4
0.39	394	0.639	1.25	0.46	0.88	1.25	-	5.0	5.0	5.0	5.0	4.6	3.7	2.5
0.47	474	0.696	1.25	0.51	0.93	1.25	28	6.8	6.3	5.8	5.2	4.5	3.6	2.6
0.56	564	0.608	1.75	0.42	0.84	1.75	26	7.4	6.9	6.3	5.6	4.8	4.0	2.8
0.68	684	0.664	1.75	0.47	0.89	1.75	25	7.8	7.2	6.6	5.9	5.1	4.2	2.9
0.82	824	0.724	1.75	0.53	0.95	1.75	22	8.1	7.5	6.9	6.2	5.3	4.3	3.1
1.0	105	0.794	1.75	0.57	1.02	1.75	18	8.6	7.9	7.3	6.5	5.6	4.6	3.6

Additional capacitance values, voltages, and tolerances are available upon request.

* AC voltage rating is at 400Hz 1.4 x VRMS + VDC should not exceed the rated VDC.

* Graphs of AC voltage vs. frequency follow.

WRAP-AND-FILL HIGH-FREQUENCY METALIZED POLYPROPYLENE FILM CAPACITORS

VOLTAGE VS. FREQUENCY TYPE 730P / 731P
160 VDC / 100 VAC

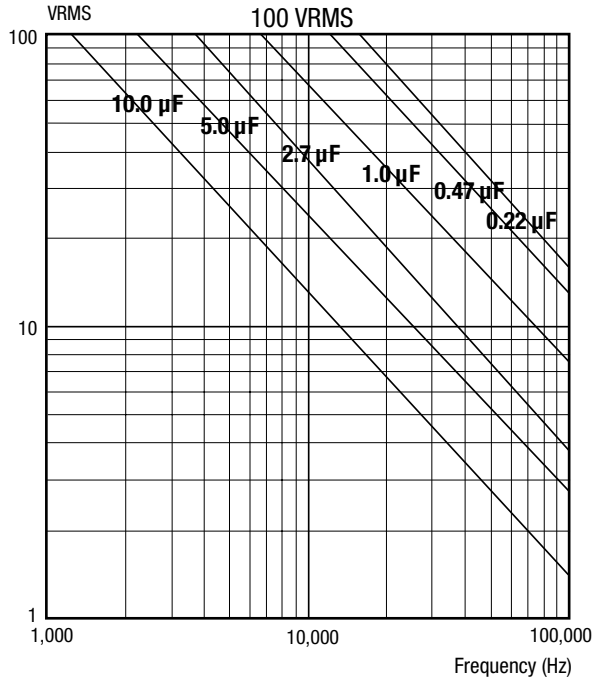

VOLTAGE VS. FREQUENCY TYPE 730P / 731P
250 VDC / 175 VAC

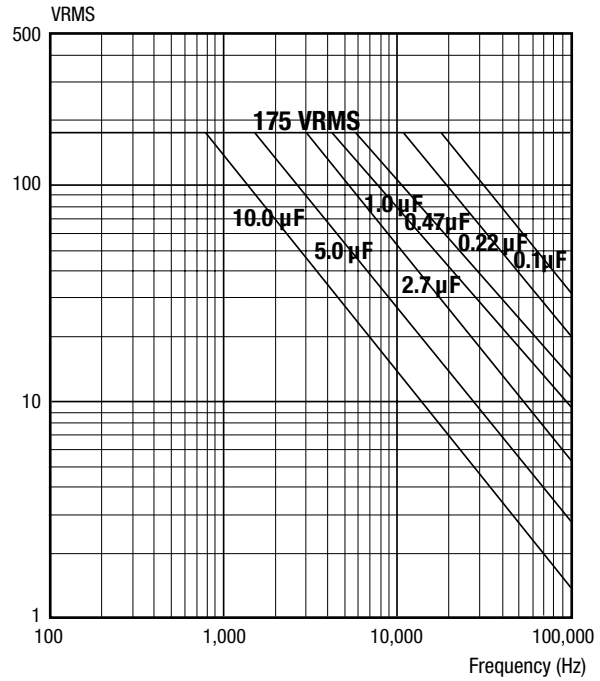

VOLTAGE VS. FREQUENCY TYPE 730P / 731P
400 VDC / 220 VAC

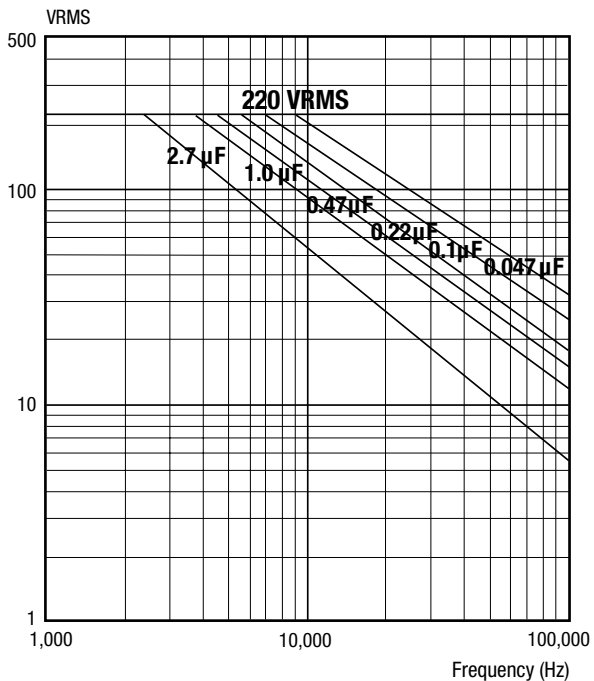

VOLTAGE VS. FREQUENCY TYPE 730P / 731P
630 VDC / 277 VAC

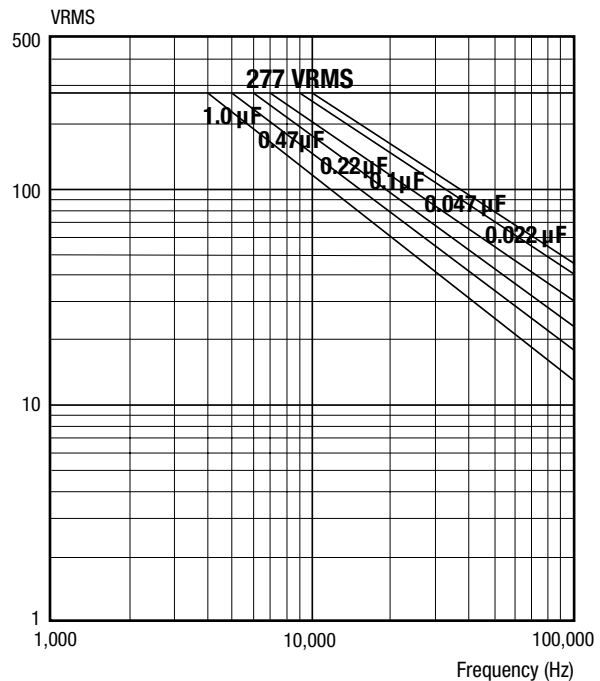

WRAP-AND-FILL HIGH VOLTAGE METALIZED POLYPROPYLENE FILM CAPACITORS

TYPE 730G



FEATURES

- AC voltage rating to 750 V
- Low power dissipation
- Close tolerance
- High stability
- High DC current

MAJOR APPLICATIONS:

Snubber, industrial controls, AC drives and inverters, UPS, charging systems, and other high voltage electronic applications.

PHYSICAL CHARACTERISTICS

CONSTRUCTION:

Non-inductive wound metalized polypropylene internal series connection.

CASE:

Flame retardant tape wrap and epoxy endfill.

LEAD MATERIAL:

Solder coated copper wire.

LEAD STRENGTH:

Capable of withstanding a five pound pull force on lead axis.

MARKING:

Dearborn trademark, type or catalog number, capacitance, tolerance and voltage.

ELECTRICAL SPECIFICATIONS

CAPACITANCE RANGE: 0.01 μ F to 2.5 μ F

VOLTAGE RATING:

- 850 VDC to 3,000 VDC
- 450 VRMS to 750 VRMS

CAPACITANCE TOLERANCE: \pm 20%, \pm 10%, \pm 5%

OPERATING TEMPERATURE: -55°C to +70°C

DISSIPATION FACTOR: 0.05% maximum

EQUIVALENT SERIES RESISTANCE: 20kHz - 100kHz, see standard ratings tables

DC VOLTAGE TEST:

130% of rated voltage for 1 minute

INSULATION RESISTANCE:

Measure at 500 VDC after a 2 minute charge.

- At +25°C, 200,000 Megaohm-Microfarads, need not exceed 400,000 Megaohms

MAXIMUM PULSE RISE TIME

Capacitor Length (inch)	Rise Time dv / dt (V / μ s)			
	850 VDC / 450 VAC	1,200 VDC / 500 VAC	2,000 VDC / 630 VAC	3,000 VDC / 750 VAC
1.250	305	1400	1750	3000
1.650	200	650	1000	1700
2.170	-	400	650	-

DIMENSIONS (in inches)

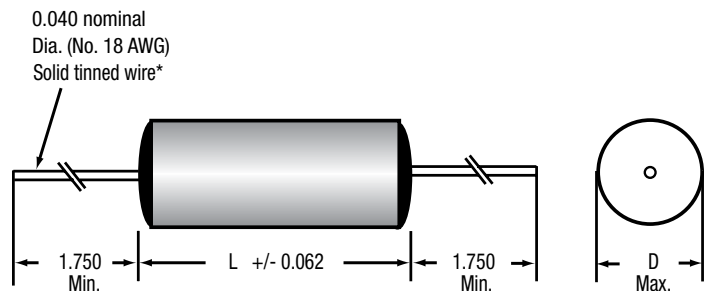

* Leads to be within \pm 0.062" of center line at egress, but not less than 0.031" from edge.

WRAP-AND-FILL HIGH VOLTAGE METALIZED POLYPROPYLENE FILM CAPACITORS

STANDARD RATINGS

Capacitance		Case Size (inches)		ESR Typical @ 100kHz MΩ	I. rms @ 100kHz-@ 70°C
μF	Code	D	L		
850 VDC / 450 VAC* (VOLTAGE CODE 850)					
0.15	154	0.400	1.250	10	5
0.22	224	0.475	1.250	7	7
0.33	334	0.570	1.250	5	9
0.47	474	0.669	1.250	4	9
0.68	684	0.800	1.250	3	9
1.00	105	0.800	1.650	3	9
1.50	155	0.965	1.650	3	11
2.00	205	1.125	1.650	2	11
2.50	255	1.240	1.650	2	11
1,200 VDC / 500 VAC* (VOLTAGE CODE 1K2)					
0.10	104	0.552	1.250	9	7
0.15	154	0.669	1.250	7	9
0.22	224	0.807	1.250	5	9
0.33	334	0.768	1.650	5	9
0.47	474	0.906	1.650	4	9
0.68	684	1.08	1.650	3	11
1.00	105	1.32	1.650	3	11
1.20	125	1.142	2.170	3	11
2,000 VDC / 630 VAC* (VOLTAGE CODE 2K0)					
0.022	223	0.413	1.250	32	3
0.033	333	0.492	1.250	22	4
0.047	473	0.571	1.250	16	5
0.068	683	0.669	1.250	11	7
0.10	104	0.807	1.250	8	9
0.15	154	0.768	1.650	8	9
0.22	224	0.925	1.650	6	9
0.33	334	1.122	1.650	4	11
0.47	474	1.320	1.650	4	11
0.56	564	1.142	2.170	4	11
3,000 VDC / 750 VAC* (VOLTAGE CODE 3K0)					
0.010	103	.0472	1.250	62	2
0.015	153	0.551	1.250	42	3
0.022	223	0.650	1.250	29	4
0.033	333	0.787	1.250	20	5
0.047	473	0.728	1.650	18	6
0.068	683	0.866	1.650	13	8
0.10	104	1.043	1.650	9	11
0.15	154	1.260	1.650	7	11

Additional capacitance values, voltages, and tolerances are available upon request.

* AC voltage rating is at 400Hz 1.4 x VRMS + VDC should not exceed the rated VDC.

* Graphs of AC voltage vs. frequency follow.

WRAP-AND-FILL HIGH VOLTAGE METALIZED POLYPROPYLENE FILM CAPACITORS

TYPE 730G

VOLTAGE VS. FREQUENCY TYPE 730G
850 VDC / 450 VAC

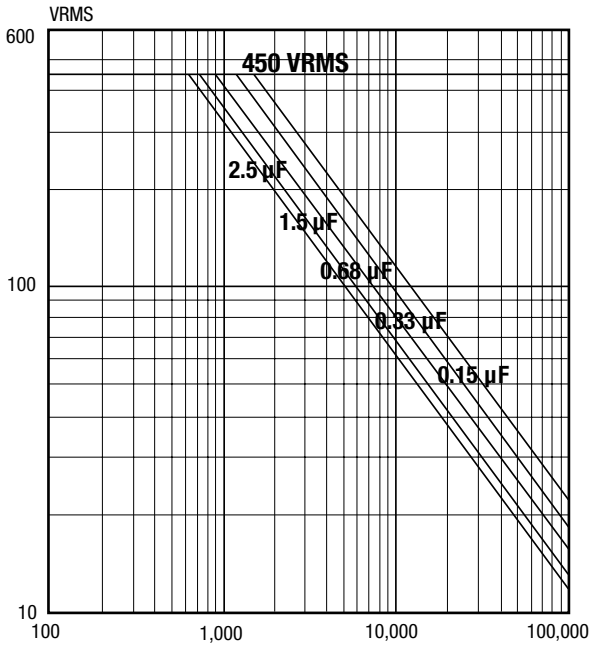

VOLTAGE VS. FREQUENCY TYPE 730G
1,200 VDC / 500 VAC

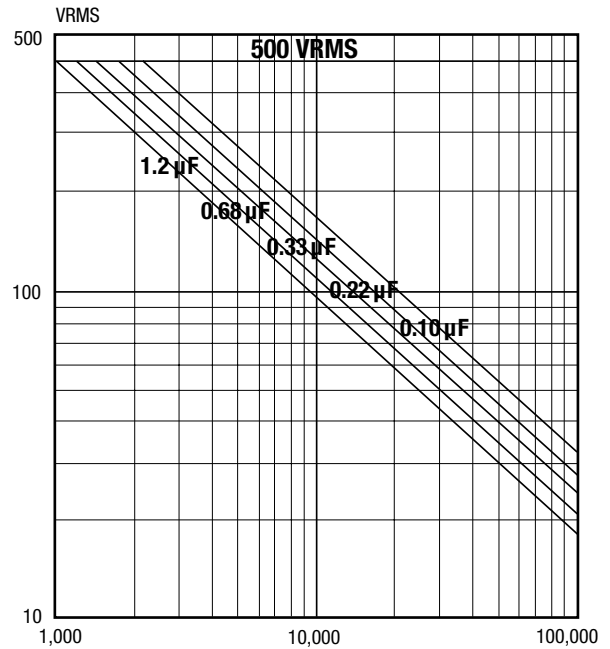

VOLTAGE VS. FREQUENCY TYPE 730G
2,000 VDC / 630 VAC

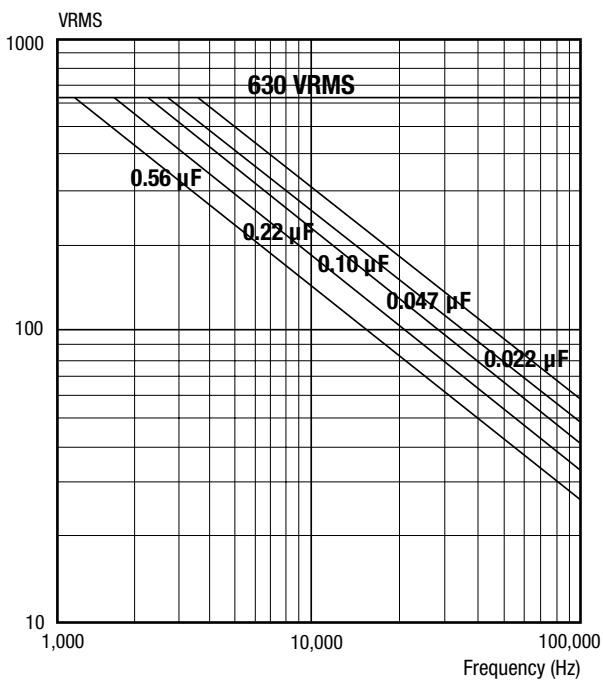

VOLTAGE VS. FREQUENCY TYPE 730G
3,000 VDC / 750 VAC

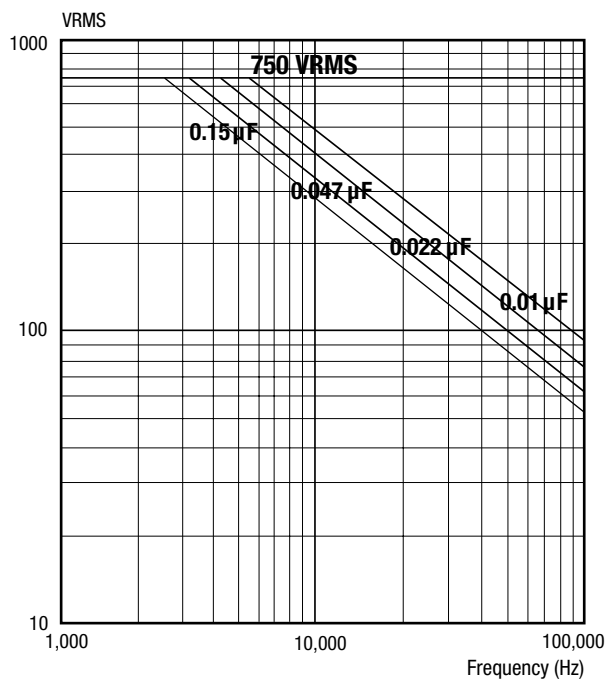

WRAP-AND-FILL OVAL CONFIGURATION METALIZED POLYPROPYLENE FILM CAPACITORS

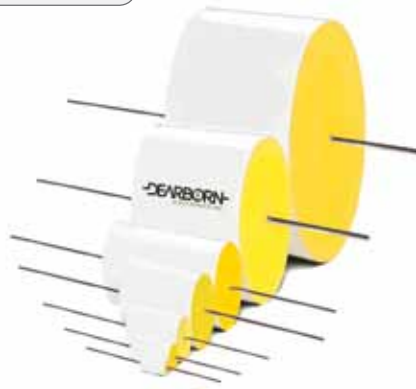

FEATURES

- New smaller size
- High stability
- High current
- Low ESR
- Low inductance
- Excellent AC performance
- Oval configuration affords economy of space

MAJOR APPLICATIONS:

High current and pulse operations, snubber circuits, oscillator circuits, SMPS applications, deflection circuits, and other applications where high capacitance, high current and small size are important.

PHYSICAL CHARACTERISTICS

CONSTRUCTION:

Non-inductive wound metalized polypropylene.

CASE:

Flame retardant tape wrap and epoxy endfill.

LEAD MATERIAL:

Solder coated copper wire.

LEAD STRENGTH:

Capable of withstanding a five pound pull force on lead axis.

MARKING:

Dearborn trademark, type or catalog number, capacitance, tolerance and voltage.

ELECTRICAL SPECIFICATIONS

CAPACITANCE RANGE: 0.47 μ F to 10.0 μ F

VOLTAGE RATING:

- 400 VDC to 600 VDC
- 220 VRMS to 277 VRMS

CAPACITANCE TOLERANCE: \pm 20%, \pm 10%, \pm 5%

OPERATING TEMPERATURE: -55°C to +105°C

VOLTAGE DERATING: At +105°C, 70% of the 85°C rating

DISSIPATION FACTOR: 0.07% maximum

EQUIVALENT SERIES RESISTANCE: 20kHz - 100kHz, see standard rating table

DC VOLTAGE TEST: 200% of rated voltage for 2 minutes

INSULATION RESISTANCE:

Measure at 100 VDC after a 2 minute charge.

- At +25°C, 200,000 Megaohm-Microfarads, need not exceed 400,000 Megaohms
- At +85°C, 10,000 Megaohm-Microfarads, need not exceed 20,000 Megaohms
- At +105°C, 1,000 Megaohm-Microfarads, need not exceed 2,000 Megaohms

MAXIMUM PULSE RISE TIME

Capacitor Length (inch)	Rise Time dv / dt (V / μ s)	
	400 VDC	600 VDC
1.25	35	50
1.50	-	38
1.75	19	-
2.25	14	22

DIMENSIONS (in inches)

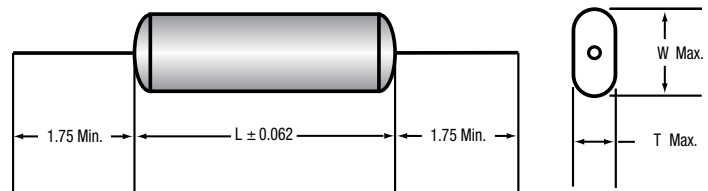

WRAP-AND-FILL OVAL CONFIGURATION METALIZED POLYPROPYLENE FILM CAPACITORS

TYPE 734G

STANDARD RATINGS

Capacitance μF	Catalog Number	Case Size (inches)			Lead Size AWG	Typical ESR (MΩ)	Current (A)
		T	W	L			
400 VDC / 220 VAC*							
0.47	734G474X0400	0.28	0.53	1.25	20	21	4
0.68	734G684X0400	0.30	0.59	1.25	20	13	6
1.00	734G105X0400	0.39	0.65	1.25	20	11	9
1.50	734G155X0400	0.48	0.75	1.25	20	9	10
2.20	734G225X0400	0.56	0.89	1.25	20	8	11
3.30	734G335X0400	0.69	0.99	1.25	20	7	15
4.70	734G475X0400	0.64	0.95	1.75	18	7	17
6.80	734G685X0400	0.67	0.96	2.25	18	7	17
10.00	734G106X0400	0.75	1.25	2.25	18	7	18
600 VDC / 277 VAC*							
0.47	734G474X0600	0.46	0.75	1.25	20	13	4
0.68	734G684X0600	0.55	0.85	1.25	20	10	6
1.00	734G105X0600	0.67	0.97	1.25	20	8	9
1.50	734G155X0600	0.73	1.03	1.50	20	7	11
2.20	734G225X0600	0.64	0.94	2.25	18	10	13
3.30	734G335X0600	0.70	1.05	2.25	18	9	16
4.70	734G475X0600	0.80	1.30	2.25	18	8	17
5.00	734G505X0600	0.95	1.25	2.25	18	7	18
6.80	734G685X0600	1.00	1.50	2.25	18	7	18
10.00	734G106X0600	1.20	1.80	2.25	18	7	18

Additional capacitance values, voltages, and tolerances are available upon request.

* AC voltage rating is at 400Hz 1.4 x VRMS + VDC should not exceed the rated VDC.

* Graphs of AC voltage vs. frequency follow.

WRAP-AND-FILL HIGH-CURRENT METALIZED POLYPROPYLENE FILM CAPACITOR



FEATURES

- Wire or lug terminals
- High stability
- High ripple to 30 A
- Low inductance
- Low ESR
- Approved to MIL-PRF-55514/9

MAJOR APPLICATIONS:

Specifically designed for SMPS applications, pulse operations, deflection-circuits, high frequency coupling and decoupling, sampling and hold circuits, and other applications where high capacitance, high current, and low ESR are important.

PHYSICAL CHARACTERISTICS

CONSTRUCTION:

Non-inductive wound metalized polypropylene.

CASE:

Flame retardant tape wrap and epoxy endfill.

LEAD MATERIAL:

Solder coated copper wire.

LEAD WIRE SIZES:

TERMINAL STYLE L	
Case Dia.	Lead AWG
< 0.700	0.032 (No. 20)
≥ 0.700	0.040 (No. 18)

LEAD STRENGTH:

Capable of withstanding a five pound pull force on lead axis; lugs will withstand a ten pound pull force on lug axis.

MARKING:

Dearborn trademark, type or catalog number, capacitance, tolerance and voltage.

ELECTRICAL SPECIFICATIONS

Capacitance Range: 1.0 μ F to 30.0 μ F

Voltage Rating:

- 100 VDC to 400 VDC
- 70 VRMS to 220 VRMS

Capacitance Tolerance: \pm 20%, \pm 10%, \pm 5%

Operating Temperature: -55°C to +105°C

VOLTAGE DERATING:

- There is no derating for DC operation
- For AC operation derate 70% for applications above 85°C

DISSIPATION FACTOR: 0.07% maximum

EQUIVALENT SERIES RESISTANCE: 20kHz - 100kHz, see standard ratings tables

DC VOLTAGE TEST: 200% of rated voltage for 2 minutes

INSULATION RESISTANCE:

Measure at rated VDC after a 2 minute charge.

- At +25°C, 200,000 Megaohm-Microfarads, need not exceed 400,000 Megaohms
- At +105°C, 1,000 Megaohm-Microfarads, need not exceed 2,000 Megaohms

MAXIMUM PULSE RISE TIME

Capacitor Length (inch)	Rise Time dv / dt (V / μ s)		
	100 VDC / 70 VAC	200 VDC / 140 VAC	400 VDC / 220 VAC
0.750 / 0.875	55	-	-
0.938 / 1.062	33	-	-
1.250 / 1.375	22	33	-
1.500 / 1.625	17	28	44
1.750 / 1.875	-	27	33
2.250 / 2.375	9	20	24

DIMENSIONS (in inches)

TERMINAL STYLE L

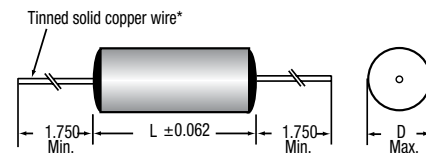

TERMINAL STYLE H

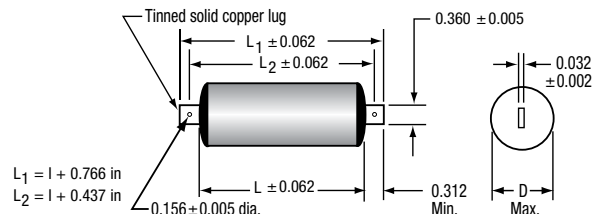

WRAP-AND-FILL HIGH-CURRENT METALIZED POLYPROPYLENE FILM CAPACITOR

TYPE 735P

STANDARD RATINGS

Capacitance		Case Size (inches)		ESR Limit MΩ 20-100kHz	Maximum Ripple Current (Amps) at 20-100kHz Case temperature						
μF	Code	D	L		+25°C	+35°C	+45°C	+55°C	+65°C	+75°C	+85°C
TERMINAL STYLE L - UNIT WITH WIRE LEADS											
100 VDC / 70 VAC* (VOLTAGE CODE 100)											
1	105	0.531	0.750	15	9.2	8.5	7.8	7.0	6.0	4.9	4.5
2	205	0.596	0.938	12	10.8	10.0	9.1	8.2	7.0	5.8	5.3
3	305	0.717	0.938	11	12.1	11.2	10.3	9.2	8.0	6.5	5.9
5	505	0.733	1.250	10	13.8	12.7	11.6	10.4	9.0	7.4	6.7
10	106	0.898	1.500	10	15.0	15.0	14.2	12.7	11.0	9.0	8.2
20	206	1.000	2.250	10	15.0	15.0	15.0	15.0	13.6	11.1	10.0
30	306	1.200	2.250	9	15.0	15.0	15.0	15.0	15.0	12.4	11.4
200 VDC / 140 VAC* (VOLTAGE CODE 200)											
1	105	0.512	1.250	20	7.3	7.3	7.3	7.3	7.2	5.9	5.4
2	205	0.698	1.250	15	12.0	12.0	11.3	10.1	8.7	7.1	6.5
3	305	0.747	1.500	13	15.0	13.8	12.3	11.3	9.8	8.0	7.3
5	505	0.862	1.750	11	15.0	15.0	14.7	13.1	11.4	9.3	8.5
10	106	1.030	2.250	10	15.0	15.0	15.0	15.0	13.8	11.3	10.3
20	206	1.440	2.250	9	15.0	15.0	15.0	15.0	15.0	14.1	12.8
400 VDC / 220 VAC* (VOLTAGE CODE 400)											
1	105	0.713	1.500	19	9.5	9.5	9.5	9.5	9.5	7.8	7.1
2	205	0.895	1.750	15	15.0	15.0	15.0	13.4	11.6	9.5	8.7
3	305	1.086	1.750	14	15.0	15.0	15.0	15.0	13.1	10.7	9.8
5	505	1.192	2.250	12	15.0	15.0	15.0	15.0	15.0	12.5	11.4
10	106	1.668	2.250	9	15.0	15.0	15.0	15.0	15.0	15.0	14.1
TERMINAL STYLE H - UNIT WITH TERMINAL LUGS											
100 VDC / 70 VAC* (VOLTAGE CODE 100)											
1	105	0.531	0.875	15	10.3	9.5	8.7	7.8	6.7	5.5	5.0
2	205	0.596	1.062	12	12.0	11.0	10.0	8.9	7.8	6.3	5.8
3	305	0.717	1.062	11	13.3	12.3	11.2	10.0	8.7	7.1	6.5
5	505	0.733	1.375	10	14.8	13.7	12.5	11.2	9.7	7.9	7.2
10	106	0.898	1.625	10	17.8	16.5	15.0	13.5	11.7	9.5	8.7
20	206	1.000	2.375	10	21.6	20.0	18.3	16.4	14.2	11.6	10.6
30	306	1.200	2.375	9	24.3	22.5	20.5	18.4	15.9	13.0	11.9
200 VDC / 140 VAC* (VOLTAGE CODE 200)											
1	105	0.512	1.375	20	7.3	7.3	7.3	7.3	7.3	6.4	5.8
2	205	0.698	1.375	15	14.3	13.3	12.1	10.8	9.4	7.7	7.0
3	305	0.747	1.625	13	15.9	14.7	13.5	12.0	10.4	8.5	7.8
5	505	0.862	1.875	11	18.3	17.0	15.5	13.9	12.0	9.8	8.9
10	106	1.030	2.375	10	22.4	20.7	18.9	16.9	14.6	12.0	10.9
20	206	1.440	2.375	9	27.4	25.4	23.2	20.7	17.9	14.7	13.4
400 VDC / 220 VAC* (VOLTAGE CODE 400)											
1	105	0.713	1.625	19	9.5	9.5	9.5	9.5	9.5	8.3	7.5
2	205	0.895	1.875	15	15.0	15.0	15.0	14.2	12.3	10.0	9.1
3	305	1.086	1.875	14	21.1	19.5	17.8	15.9	13.8	11.3	10.3
5	505	1.192	2.375	12	24.4	22.6	20.6	18.5	16.0	13.1	11.9
10	106	1.668	2.375	9	30.0	27.8	25.4	22.7	19.7	16.1	14.7

Additional capacitance values, voltages, and tolerances are available upon request.

* AC voltage rating is at 400Hz 1.4 x VRMS + VDC should not exceed the rated VDC.

* Graphs of AC voltage vs. frequency follow.

WRAP-AND-FILL HIGH-CURRENT METALIZED POLYPROPYLENE FILM CAPACITOR

UNIT WITH WIRE LEADS
VOLTAGE VS. FREQUENCY TYPE 735P
100 VDC / 70 VAC

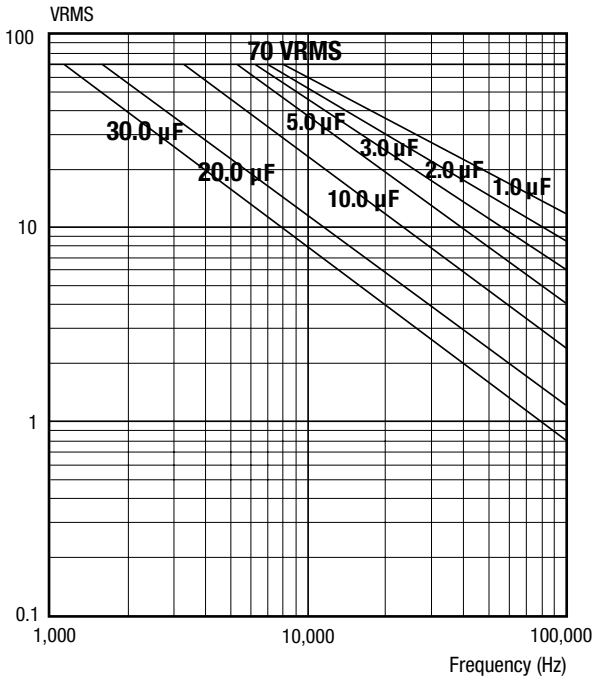

UNIT WITH WIRE LEADS
VOLTAGE VS. FREQUENCY TYPE 735P
200 VDC / 140 VAC

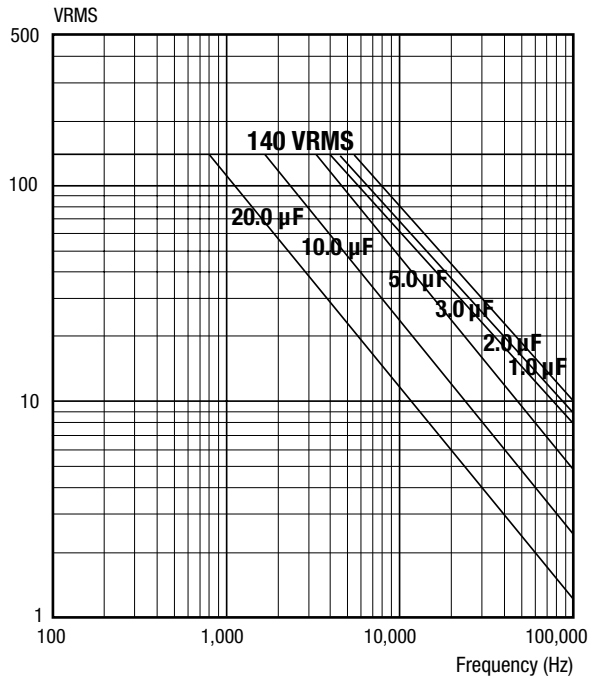

UNIT WITH WIRE LEADS
VOLTAGE VS. FREQUENCY TYPE 735P
400 VDC / 220 VAC

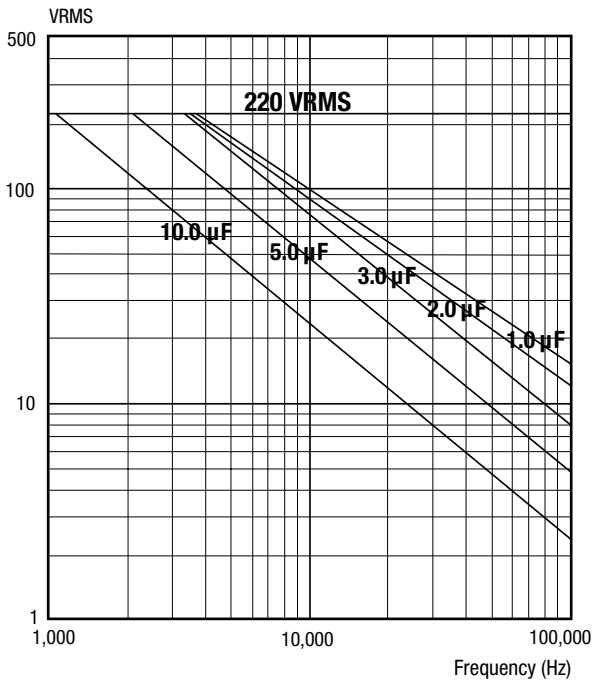

WRAP-AND-FILL HIGH-CURRENT METALIZED POLYPROPYLENE FILM CAPACITOR

TYPE 735P

UNIT WITH TERMINAL LUGS
VOLTAGE VS. FREQUENCY TYPE 735P
100 VDC / 70 VAC

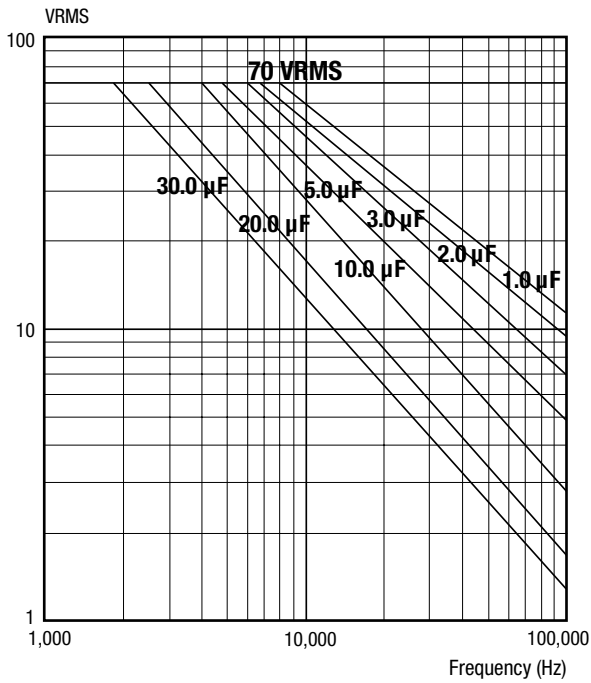

UNIT WITH TERMINAL LUGS
VOLTAGE VS. FREQUENCY TYPE 735P
200 VDC / 140 VAC

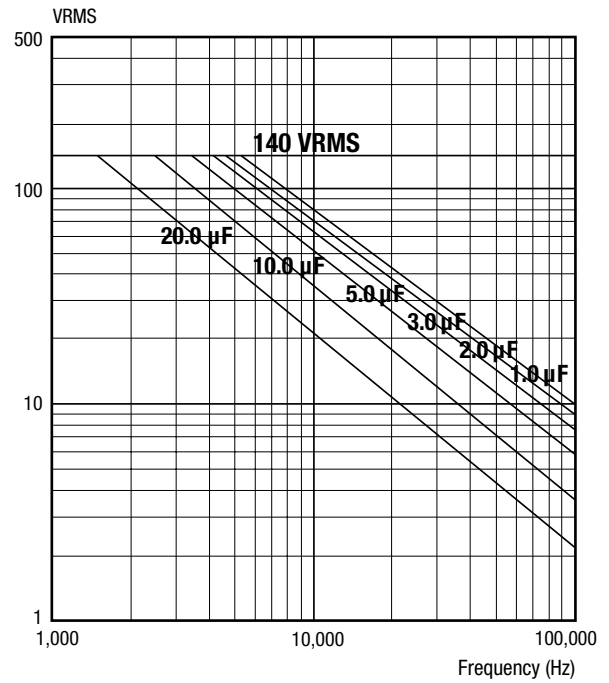

UNIT WITH TERMINAL LUGS
VOLTAGE VS. FREQUENCY TYPE 735P
400 VDC / 220 VAC

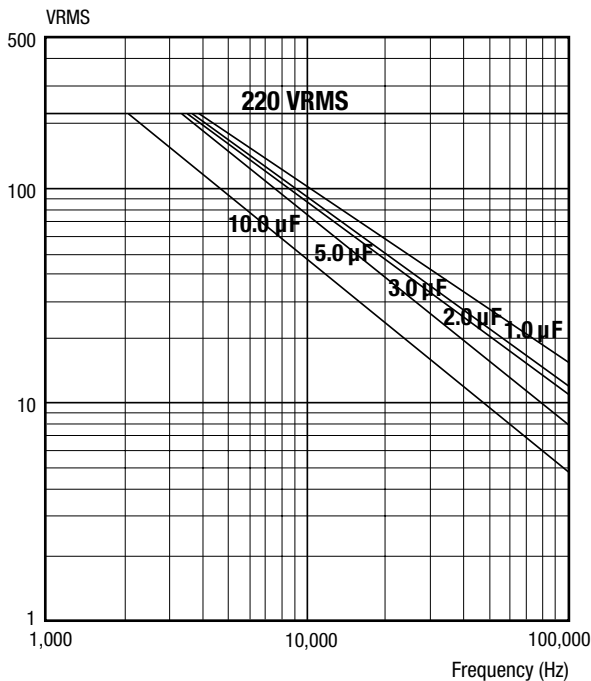

PREFORMED RECTANGULAR BOX METALIZED POLYPROPYLENE FILM CAPACITORS



FEATURES

- Flame retardant case
- Small size light weight
- High insulation resistance
- Low ESR

MAJOR APPLICATIONS:

Timing, integrating, telecommunications, AC, audio, and digital circuitry.

PHYSICAL CHARACTERISTICS

CONSTRUCTION:

Non-inductive wound metalized polypropylene.

CASE:

Flame retardant preformed case and epoxy fill.

LEAD MATERIAL:

Solder coated solid wire No. 18 AWG.

LEAD STRENGTH:

Capable of withstanding a five pound pull force on lead axis.

MARKING:

Dearborn trademark, type or catalog number, capacitance, tolerance and voltage.

ELECTRICAL SPECIFICATIONS

CAPACITANCE RANGE:

0.47 μ F to 3.5 μ F

VOLTAGE RATING:

600 VDC

CAPACITANCE TOLERANCE:

$\pm 20\%$, $\pm 10\%$, $\pm 5\%$

OPERATING TEMPERATURE:

-55°C to +105°C

VOLTAGE DERATING:

At +105°C, 70% of the 85°C rating

DISSIPATION FACTOR:

0.07% maximum

DC VOLTAGE TEST:

150% of rated voltage for 2 minutes

INSULATION RESISTANCE:

Measure at rated VDC after a 2 minute charge.

- At +25°C, 100,000 Megaohm-Microfarads, need not exceed 200,000 Megaohms

DIMENSIONS (in inches)

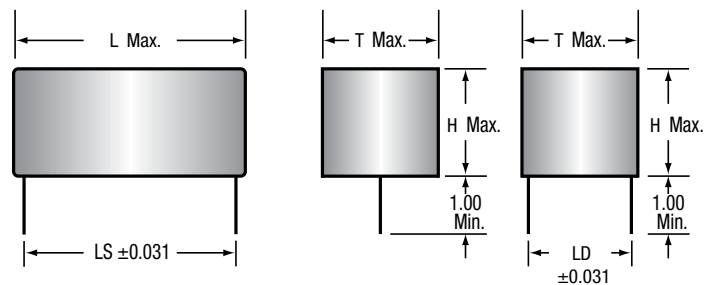

PREFORMED RECTANGULAR BOX METALIZED POLYPROPYLENE FILM CAPACITORS

TYPE 744G

STANDARD RATINGS

Capacitance μF	VDC	T	H	L	LS	LD
0.47	600	0.400	0.790	1.015	0.90	-
0.68	600	0.400	0.790	1.015	0.90	-
1.00	600	0.520	0.790	1.215	1.10	0.30
2.50	600	0.895	0.790	1.390	1.20	0.50
3.00	600	0.920	0.790	1.645	1.40	0.50
3.50	600	0.920	0.790	1.645	1.40	0.50

Additional capacitance values, voltages, and tolerances are available upon request.

IGBT SNUBBER CAPACITORS METALIZED POLYPROPYLENE FILM DIELECTRIC CAPACITORS



FEATURES

- Low ESL and ESR
- Voltage ratings to 3,000 VDC / 920 VRMS
- Ripple current greater than 20 ARMS @ 85°C
- Across the bus 23 - 28 mm terminal spacing
- 105°C operating temperature
- dv / dt Capabilities to 3,300 V / μ s

MAJOR APPLICATIONS:

Snubber, industrial controls, AC drives and inverters, UPS, charging systems, and other high voltage electronic applications.

PHYSICAL CHARACTERISTICS

CONSTRUCTION:

Non-inductive wound metalized polypropylene.

CASE:

Flame retardant molded plastic case and epoxy fill.

DIMENSIONS (in inches):

Case	Length	Width	Height
1	1.65	1.25	1.25
2	1.77	1.46	1.46

TERMINALS:

Tinned copper tabs.

MARKING:

Dearborn trademark, type or catalog number, capacitance, tolerance and voltage.

ELECTRICAL SPECIFICATIONS

CAPACITANCE RANGE:

0.10 μ F to 2.5 μ F

CAPACITANCE TOLERANCE:

\pm 20%, \pm 10%, \pm 5%

VOLTAGE RANGE:

- 800 VDC to 3,000 VDC
- 460 VRMS to 920 VRMS

VOLTAGE DERATING:

At +105°C, 70% of the 85°C rating

OPERATING TEMPERATURE:

- -55°C to +105°C for DC operation
- -55°C to +85°C for AC operation

DISSIPATION FACTOR:

0.10% maximum

EQUIVALENT SERIES INDUCTANCE:

< 26nH

EQUIVALENT SERIES RESISTANCE:

See standard ratings table

DC VOLTAGE TEST:

150% of rated voltage for 2 minutes

INSULATION RESISTANCE:

Measure at 500 VDC after a 2 minute charge.

- At +25°C, 175,000 Megaohm-Microfarads, need not exceed 350,000 Megaohms
- At +85°C, 10,000 Megaohm-Microfarads, need not exceed 20,000 Megaohms

DIMENSIONS (in inches)

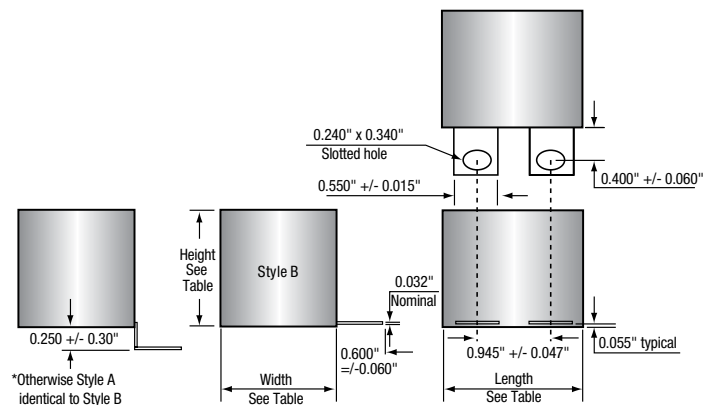

Consult factory for other terminal configurations and/or spacing.

IGBT SNUBBER CAPACITORS METALIZED POLYPROPYLENE FILM DIELECTRIC CAPACITORS

TYPE 752P

STANDARD RATINGS

Capacitance		Case Size	Typical ESR MΩ 100kHz	Max. Ripple Current at 100kHz (Amp)		I Peak (Amp)	dv / dt (V / μs)
μF	Code			50°C	85°C		
800 VDC / 460 VRMS* (Voltage Code 800)							
0.39	394	1	9.9	16.2	13.0	300	785
0.47	474	1	8.4	17.8	14.2	370	785
0.56	564	1	8.3	19.4	15.5	380	675
0.68	684	1	9.8	21.5	17.2	385	565
0.75	754	1	9.0	22.5	18.0	425	565
0.82	824	1	8.3	23.6	18.9	460	565
1.0	105	1	6.9	26.0	20.8	565	510
1.2	125	2	6.7	26.0	20.8	595	435
1.4	145	2	5.9	26.0	20.8	695	425
1.5	155	2	5.5	26.0	20.8	745	425
1.8	185	2	6.5	26.0	20.8	720	400
2.0	205	2	6.0	26.0	20.8	800	345
2.2	225	2	5.5	26.0	20.8	880	335
2.5	255	2	4.9	26.0	20.8	1000	335
1,000 VDC / 460 VRMS* (Voltage Code 1K0)							
0.33	334	1	9.6	14.9	11.9	269	895
0.39	394	1	9.9	16.2	13.0	300	785
0.47	474	1	8.4	17.8	14.2	370	785
0.56	564	1	8.3	19.4	15.5	380	675
0.68	684	1	9.8	21.5	17.2	385	565
0.75	754	1	9.0	22.5	18.0	425	565
0.82	824	1	8.3	23.6	18.9	460	565
1.0	105	1	6.9	26.0	20.8	565	510
1.2	125	2	6.7	26.0	20.8	595	435
1.4	145	2	5.9	26.0	20.8	695	425
1.5	155	2	5.5	26.0	20.8	745	425
1,200 VDC / 460 VRMS* (Voltage Code 1K2)							
0.27	274	1-2	11.6	13.5	10.8	240	895
0.33	334	1-2	9.6	14.9	11.9	269	895
0.39	394	1-2	9.9	16.2	13.0	300	785
0.47	474	1-2	8.4	17.8	14.2	370	785
0.56	564	1-2	8.3	19.4	15.5	380	675
0.68	684	1	9.8	21.5	17.2	385	565
0.75	754	1	9.0	22.5	18.0	425	565
0.82	824	1	8.3	23.6	18.9	460	565
1.0	105	1	6.9	26.0	20.8	565	510
1.2	125	2	6.7	26.0	20.8	595	435
1.4	145	2	5.9	26.0	20.8	695	425
1.5	155	2	5.5	26.0	20.8	745	425
1,600 VDC / 920 VRMS* (Voltage Code 1K6)							
0.10	104	1	16.8	8.2	6.6	308	3080
0.12	124	1	14.1	9.0	7.2	370	2945
0.15	154	1	9.8	10.1	8.1	460	2790
0.18	184	1	9.7	11.0	8.8	555	2635
0.22	224	1	9.4	13.0	10.4	585	2340
0.27	274	1-2	7.8	14.4	11.5	600	2040
0.33	334	1-2	8.0	15.9	12.7	660	1845
0.39	394	1-2	6.9	17.4	13.9	860	1750
0.47	474	1-2	7.6	19.1	15.2	860	1565
0.56	564	1-2	6.5	21.9	17.5	1030	1475

Additional capacitance values, voltages, and tolerances are available upon request.

* AC voltage rating is at 400Hz.

IGBT SNUBBER CAPACITORS METALIZED POLYPROPYLENE FILM DIELECTRIC CAPACITORS

STANDARD RATINGS

Capacitance		Case Size	Typical ESR M Ω 100kHz	Max. Ripple Current at 100kHz (Amp)		I Peak (Amp)	dv / dt (V / μ s)
μ F	Code			50°C	85°C		
2,000 VDC / 920 VRMS* (Voltage Code 2K0)							
0.10	104	1	16.8	8.2	6.6	308	3080
0.12	124	1	14.1	9.0	7.2	370	2945
0.15	154	1	9.8	10.1	8.1	460	2790
0.18	184	1	9.7	11.0	8.8	555	2635
0.22	224	1	9.4	13.0	10.4	585	2340
0.27	274	2	7.8	14.4	11.5	600	2040
0.33	334	2	8.2	15.9	12.7	660	1845
0.39	394	2	6.9	17.4	13.9	860	1750
2,400 VDC / 920 VRMS* (Voltage Code 2K4)							
0.10	104	1	16.8	8.2	6.6	308	3080
0.12	124	1	14.1	9.0	7.2	370	2945
0.15	154	1	9.8	10.1	8.1	460	2790
0.18	184	1	9.7	11.0	8.8	555	2635
0.22	224	1	9.4	13.0	10.4	585	2340
0.27	274	2	7.8	14.4	11.5	600	2040
0.33	334	2	8.0	15.9	12.7	660	1845
3,000 VDC / 920 VRMS* (Voltage Code 3K0)							
0.10	104	1	14.1	8.2	6.6	350	3315
0.12	124	1	11.9	9.0	7.2	420	3160
0.15	154	2	11.3	11.3	9.0	440	2570
0.18	184	2	9.5	12.4	9.9	525	2475
0.22	224	2	7.9	13.7	11.0	640	2385

Additional capacitance values, voltages, and tolerances are available upon request.

* AC voltage rating is at 400Hz.

TYPICAL IMPEDANCE CURVE

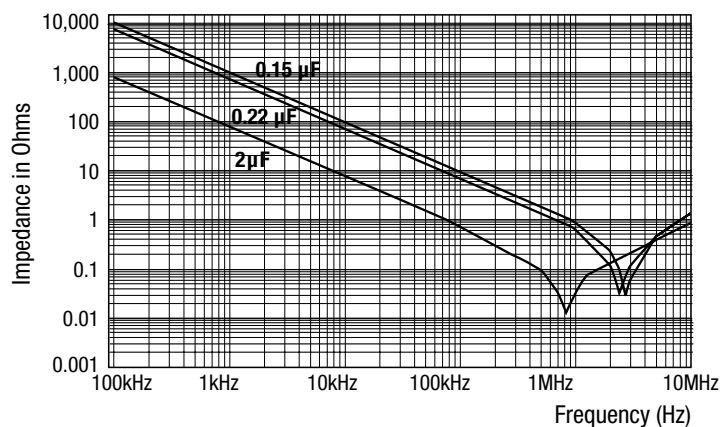

METALIZED POLYPROPYLENE FILM CAPACITOR ALTERNATIVE TO ALUMINUM ELECTROLYTICS

TYPE 781P



FEATURES

- Non-polar construction
- Voltage ratings to 1,800 VDC
- Superior performance from -55°C to +85°C
- Greater current density
- Higher over voltage protection
- Dry construction eliminates electrolyte leakage
- Improved reliability
- Longer shelf life

MAJOR APPLICATIONS:

Filmlytics offer the same package dimensions and terminations as standard electrolytics with all the advantages of self-healing metalized film electrodes and the superior performance of film capacitors.

PHYSICAL CHARACTERISTICS

CONSTRUCTION: Dry, non-inductively wound metalized film.

CASE: Aluminum case with plastic insulating sleeve.

TERMINALS: High current terminals mounted on a plastic deck.

MARKING:

Dearborn trademark, type or catalog number, capacitance, tolerance and voltage.

CAPACITANCE CHANGE VS. TEMPERATURE

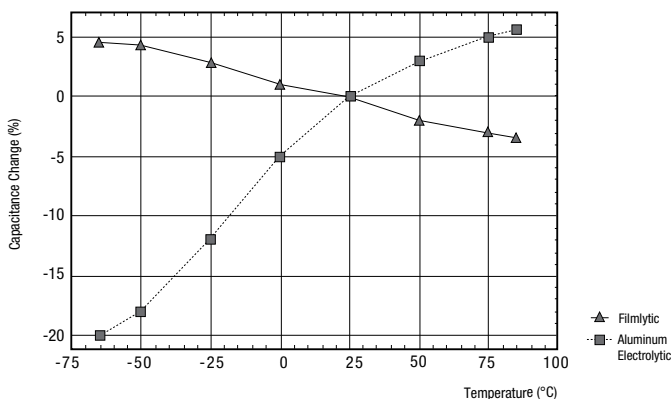

ELECTRICAL SPECIFICATIONS

CAPACITANCE TOLERANCE:

±20%, ±10%

CAPACITANCE CHANGE:

±5% from -55°C to +85°C

OPERATING TEMPERATURE:

-55°C to +85°C

DISSIPATION FACTOR:

1.0% Maximum at 1kHz

DC VOLTAGE TEST:

140% of rated voltage for 1 minute

INSULATION RESISTANCE:

Measure at 500 VDC after a 10 minute charge.

- At +25°C, 20,000 Megaohm-Microfarads
- At +85°C, 2,000 Megaohm-Microfarads

COEFFICIENTS FOR RIPPLE CURRENT

Temperature	25°C	50°C	70°C
	1.7x	1.4x	1x

Frequency Voltage Rating	60Hz	120Hz	400Hz	1kHz
	600, 800, 900	0.17x	0.35x	1x
1,000, 1,200	0.14x	0.28x	1x	1.58x
1,300, 1,500	0.11x	0.22x	1x	1.58x
1,800	0.08x	0.16x	1x	1.58x

DIMENSIONS (in inches)

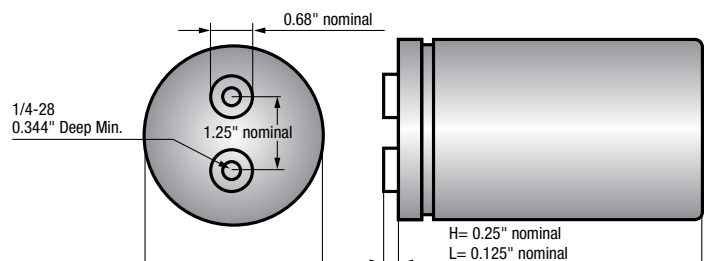

METALIZED POLYPROPYLENE FILM CAPACITOR ALTERNATIVE TO ALUMINUM ELECTROLYTICS

STANDARD RATINGS

Capacitance		Case Size	Typical ESR M Ω 100kHz	dv / dt (V / μ s)	Max. I. rms @70°C, 400Hz
μ F	Code				
600 VDC (Voltage Code 600)					
200	207	3.2	6.3	8.3	38.8
300	307	4.2	9.1	5.3	53.6
400	407	5.2	11.8	3.9	68.3
800 VDC (Voltage Code 800)					
120	127	3.2	8.0	10.3	29.4
190	197	4.2	11.1	6.6	42.5
260	267	5.2	13.9	4.8	56.1
900 VDC (Voltage Code 900)					
85	856	3.2	8.8	12.8	25.2
130	137	4.2	12.4	8.1	36.3
180	187	5.2	16.5	5.9	46.2
1,000 VDC (Voltage Code 1K0)					
60	606	3.2	10.4	15.0	20.9
95	95	4.2	14.9	9.5	30.0
130	137	5.2	19.3	6.9	39.0
1,200 VDC (Voltage Code 1K2)					
45	456	3.2	11.1	18.5	18.5
70	706	4.2	16.6	11.3	25.9
100	107	5.2	21.1	8.2	34.6
1,300 VDC (Voltage Code 1K3)					
35	356	3.2	12.5	20.7	16.2
55	556	4.2	18.6	12.7	22.9
75	756	5.2	24.7	9.2	29.5
1,500 VDC (Voltage Code 1K5)					
28	286	3.2	13.9	23.1	14.4
45	456	4.2	20.3	14.2	20.8
65	656	5.2	25.6	10.2	28.1
1,800 VDC (Voltage Code 1K8)					
18	186	3.2	16.3	30.1	11.6
30	306	4.2	23.9	17.9	17.0
42	426	5.2	31.5	12.7	22.3

Additional capacitance values, voltages, and tolerances are available upon request.

WRAP-AND-FILL HIGH FREQUENCY POLYPROPYLENE FILM / FOIL CAPACITORS

TYPE 710P



FEATURES

- Extended foil construction
- Low-loss
- High average AC current
- Moisture resistant
- Approved to MIL-PRF-55514 / 10

MAJOR APPLICATIONS:

High current and high pulse operations, protection circuits in SMPS, snubber and SCR commutating circuits, oscillator, timing and filter circuits, high frequency coupling.

PHYSICAL CHARACTERISTICS

CONSTRUCTION:

Polypropylene film extended aluminum foil.

CASE:

Flame retardant polyester tape wrap and epoxy endfill.

LEAD MATERIAL:

Solder coated solid wire.

LEAD STRENGTH:

Capable of withstanding a five pound pull force on lead axis.

MARKING:

Dearborn trademark, type or catalog number, capacitance, tolerance and voltage.

ELECTRICAL SPECIFICATIONS

CAPACITANCE RANGE: 0.001 μ F to 1.0 μ F

VOLTAGE RATING:

- 200 VDC to 800 VDC
- 155 VRMS to 500 VRMS

CAPACITANCE TOLERANCE: \pm 20%, \pm 10%, \pm 5%

OPERATING TEMPERATURE: -55°C to +105°C

VOLTAGE DERATING:

- At +105°C, 70% of the 85° rating for DC applications.
- For AC applications above 85°C, see Table 1.

DISSIPATION FACTOR: 0.1% maximum

DC VOLTAGE TEST: 250% of rated voltage for 5 seconds

INSULATION RESISTANCE:

Measured at rated VDC after a 2 minute test.

- At +25°C, 200,000 Megaohm-Microfarads, need not exceed 400,000 Megaohms
- At +85°C, 10,000 Megaohm-Microfarads, need not exceed 20,000 Megaohms
- At +105°C, 1,000 Megaohm-Microfarads, need not exceed 2,000 Megaohms

MAXIMUM PULSE RISE TIME

Capacitor Length (inch)	Rise Time dv / dt (v / μ s)			
	200 VDC	400 VDC	600 VDC	800 VDC
0.750	1000	1800	3000	-
0.938	700	1000	2000	-
1.250	450	650	1000	1500
1.688	400	500	700	1000
2.063	300	-	600	800
2.438	-	400	500	600

DIMENSIONS (in inches)

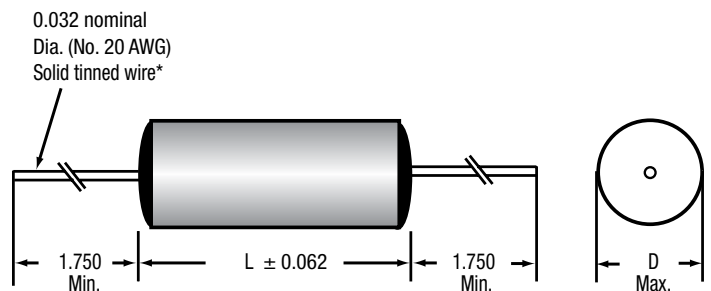

* Leads to be within \pm 0.062" of center line at egress, but not less than 0.031" from edge.

WRAP-AND-FILL HIGH FREQUENCY POLYPROPYLENE FILM / FOIL CAPACITORS

TABLE 1: AC VOLTAGE RATINGS

Capacitance Range	1,000Hz		5,000Hz		10,000Hz		15,000Hz		20,000Hz - Voltage RMS		Max. AC Life test
	85°C	105°C	85°C	105°C	85°C	105°C	85°C	105°C	85°C	105°C	
200 V											
0.012 - 0.068	155	75	115	75	85	60	70	50	60	45	155
0.082 - 0.47	155	75	75	60	55	40	45	35	40	30	155
0.68 - 1.0	155	75	75	50	55	30	45	20	40	15	155
400 V											
0.0039 - 0.033	200	100	190	100	135	105	110	85	95	75	200
0.039 - 0.47	200	100	100	80	75	55	60	45	50	40	200
0.68 - 1.0	200	100	100	50	75	30	60	20	50	15	200
600 V											
0.001 - 0.033	200	140	200	165	160	120	130	100	110	85	200
0.039 - 0.22	200	140	125	95	90	65	75	55	65	45	200
0.27 - 1.0	200	100	125	55	90	30	75	20	60	15	200
800 V											
0.0056 - 0.033	500	250	500	190	500	150	450	120	405	100	500
0.039 - 0.10	500	250	400	120	240	100	185	75	140	60	500
0.12 - 0.56	500	195	280	75	160	45	115	30	85	20	500

STANDARD RATINGS

Capacitance		Voltage Code 200 200 VDC / 155 VAC*		Voltage Code 400 400 VDC / 200 VAC*		Voltage Code 600 600 VDC / 240 VAC*		Voltage Code 800 800 VDC / 500 VAC*	
µF	Code	D	L	D	L	D	L	D	L
0.0010	102	-	-	-	-	0.290	0.750	-	-
0.0012	122	-	-	-	-	0.305	0.750	-	-
0.0015	152	-	-	-	-	0.305	0.750	-	-
0.0018	182	-	-	-	-	0.315	0.750	-	-
0.0022	222	-	-	-	-	0.315	0.750	-	-
0.0027	272	-	-	-	-	0.320	0.750	-	-
0.0033	332	-	-	-	-	0.320	0.750	-	-
0.0039	392	-	-	0.240	0.750	0.330	0.750	-	-
0.0047	472	-	-	0.240	0.750	0.330	0.750	-	-
0.0056	562	-	-	0.270	0.750	0.360	0.750	0.275	1.250
0.0068	682	-	-	0.270	0.750	0.360	0.750	0.275	1.250
0.0082	822	-	-	0.290	0.750	0.340	0.938	0.315	1.250
0.010	103	-	-	0.290	0.750	0.340	0.938	0.315	1.250
0.012	123	0.250	0.750	0.330	0.750	0.390	0.938	0.365	1.250
0.015	153	0.250	0.750	0.330	0.750	0.390	0.938	0.365	1.250
0.018	183	0.290	0.750	0.325	0.938	0.450	0.938	0.430	1.250
0.022	223	0.290	0.750	0.325	0.938	0.450	0.938	0.430	1.250
0.027	273	0.335	0.750	0.375	0.938	0.435	1.250	0.515	1.250
0.033	333	0.335	0.750	0.375	0.938	0.435	1.250	0.515	1.250
0.039	393	0.315	0.938	0.355	1.250	0.490	1.250	0.495	1.688
0.047	473	0.315	0.938	0.355	1.250	0.490	1.250	0.495	1.688
0.056	563	0.375	0.938	0.415	1.250	0.590	1.250	0.595	1.688
0.068	683	0.375	0.938	0.415	1.250	0.590	1.250	0.595	1.688
0.082	823	0.360	1.250	0.485	1.250	0.690	1.250	0.700	1.688
0.10	104	0.360	1.250	0.485	1.250	0.690	1.250	0.700	1.688
0.12	124	0.420	1.250	0.570	1.250	0.670	1.688	0.755	2.063
0.15	154	0.420	1.250	0.570	1.250	0.670	1.688	0.755	2.063
0.18	184	0.495	1.250	0.595	1.688	0.800	1.688	0.910	2.063
0.22	224	0.495	1.250	0.595	1.688	0.800	1.688	0.910	2.063
0.33	334	0.510	1.688	0.690	1.688	0.876	2.063	0.985	2.438
0.39	394	0.510	1.688	0.690	1.688	1.032	2.063	0.985	2.438
0.47	474	0.590	1.688	0.830	1.688	1.032	2.063	1.220	2.438
0.56	564	0.590	1.688	0.830	1.688	1.096	2.438	1.220	2.438
0.68	684	0.799	1.688	0.911	2.438	1.096	2.438	1.220	2.438
0.82	824	0.821	2.063	1.091	2.438	1.316	2.438	-	-
1.00	105	0.821	2.063	1.091	2.438	1.316	2.438	-	-

Additional capacitance values, voltages, and tolerances are available upon request.
* AC voltage rating is at 400Hz 1.4 x VRMS + VDC should not exceed the rated VDC.

WRAP-AND-FILL METALIZED POLYPHENYLENE SULFIDE FILM CAPACITORS

TYPE 832P



FEATURES

- High temperature to 125°C
- Superior performance
- High efficiency
- High stability
- High reliability
- Rugged construction
- Small size

MAJOR APPLICATIONS:

Filtering, timing, storage, and integrating circuits.

PHYSICAL CHARACTERISTICS

CONSTRUCTION:

Non-inductive wound metalized polyphenylene sulfide.

CASE: Flame retardant tape wrap and epoxy endfill.

LEAD MATERIAL: Solder coated solid wire.

LEAD WIRE SIZES:

Case Dia.	Lead AWG
< 0.230	0.020 (No. 24)
< 0.350	0.025 (No. 22)
≥ 0.350	0.032 (No. 20)

LEAD STRENGTH:

Capable of withstanding a five pound pull force on lead axis.

MARKING:

Dearborn trademark, type or catalog number, capacitance, tolerance and voltage.

ELECTRICAL SPECIFICATIONS

CAPACITANCE RANGE: 0.001 μF to 10.0 μF

VOLTAGE RATING:

- 63 VDC to 400 VDC
- 40 VRMS to 200 VRMS

CAPACITANCE TOLERANCE: $\pm 10\%$, $\pm 5\%$, $\pm 2\%$

OPERATING TEMPERATURE:

-55°C to +125°C without derating for DC operation

AC OPERATION: Limited to +105°C

DISSIPATION FACTOR: 0.15% maximum when measured at 1kHz @ 25°C

DC VOLTAGE TEST: 200% of rated voltage for 1 minute

INSULATION RESISTANCE:

Measure at rated VDC after a 2 minute charge.

- At + 25°C, 50,000 Megaohm-Microfarads, need not exceed 100,000 Megaohms
- At + 85°C, 2,000 Megaohm-Microfarads, need not exceed 4,000 Megaohms
- At + 125°C, 250 Megaohm-Microfarads, need not exceed 500 Megaohms

MAXIMUM PULSE RISE TIME

Capacitor Length (inch)	Rise Time dv / dt (V / μs)			
	63 V	100 V	250 V	400 V
0.440	25	35	57	100
0.560	17	23	38	65
0.750	9	14	20	35
1.000	6	9	14	20
1.250	5	7	11	17
1.310	4	6	-	16
1.500	-	5	-	-
1.560	-	-	6	-
1.810	-	-	5	10
2.060	-	-	4	-
2.310	-	-	-	7

DIMENSIONS (in inches)

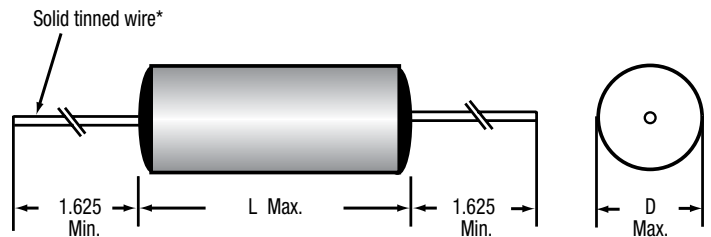

* Leads to be within ± 0.062 " of center line at egress, but not less than 0.031" from edge.

WRAP-AND-FILL METALIZED POLYPHENYLENE SULFIDE FILM CAPACITORS

STANDARD RATINGS

Capacitance		Voltage Code 063 63 VDC / 40 VAC*		Voltage Code 100 100 VDC / 63 VAC*		Voltage Code 250 250 VDC / 160 VAC*		Voltage Code 400 400 VDC / 200 VAC*	
μF	Code	D	L	D	L	D	L	D	L
0.0010	102	-	-	-	-	0.170	0.440	0.190	0.440
0.0015	152	-	-	-	-	0.170	0.440	0.190	0.440
0.0022	222	-	-	-	-	0.170	0.440	0.190	0.440
0.0033	332	-	-	-	-	0.170	0.440	0.230	0.440
0.0047	472	-	-	-	-	0.170	0.440	0.230	0.440
0.0068	682	-	-	-	-	0.170	0.440	0.230	0.560
0.010	103	0.170	0.440	0.170	0.440	0.190	0.560	0.230	0.560
0.015	153	0.170	0.440	0.170	0.440	0.190	0.560	0.230	0.750
0.022	223	0.170	0.440	0.190	0.440	0.190	0.560	0.310	0.750
0.033	333	0.170	0.440	0.190	0.440	0.230	0.560	0.310	0.750
0.047	473	0.170	0.440	0.190	0.560	0.230	0.560	0.400	0.750
0.068	683	0.170	0.560	0.230	0.560	0.270	0.560	0.400	0.750
0.10	104	0.190	0.560	0.230	0.560	0.310	0.560	0.400	1.000
0.15	154	0.230	0.440	0.310	0.560	0.310	0.750	0.400	1.250
0.22	224	0.230	0.560	0.250	0.750	0.350	0.750	0.500	1.250
0.33	334	0.250	0.560	0.310	0.750	0.370	1.000	0.550	1.310
0.47	474	0.310	0.560	0.370	0.750	0.400	1.000	0.550	1.810
0.68	684	0.310	0.560	0.400	0.750	0.450	1.000	0.650	1.810
1.00	105	0.310	0.750	0.400	1.000	0.550	1.000	0.750	1.810
1.50	155	0.350	0.750	0.450	1.000	0.500	1.250	0.900	2.310
2.00	205	0.400	0.750	0.450	1.000	0.550	1.810	1.000	2.310
2.50	255	0.400	0.750	0.500	1.250	-	-	-	-
3.00	305	0.400	1.000	0.500	1.250	-	-	-	-
4.00	405	0.400	1.250	0.500	1.500	-	-	-	-
5.00	505	0.500	1.250	0.600	1.310	-	-	-	-
6.00	605	0.550	1.000	-	-	-	-	-	-
7.00	705	0.600	1.000	-	-	-	-	-	-
10.00	106	0.600	1.310	-	-	-	-	-	-

Additional capacitance values, voltages, and tolerances are available upon request.

* AC voltage rating is at 400Hz 1.4 x VRMS + VDC should not exceed the rated VDC.

* Graphs of AC voltage vs. frequency follow.

WRAP-AND-FILL METALIZED POLYPHENYLENE SULFIDE FILM CAPACITORS

TYPE 832P

VOLTAGE VS. FREQUENCY TYPE 832P
63 VDC / 40 VAC

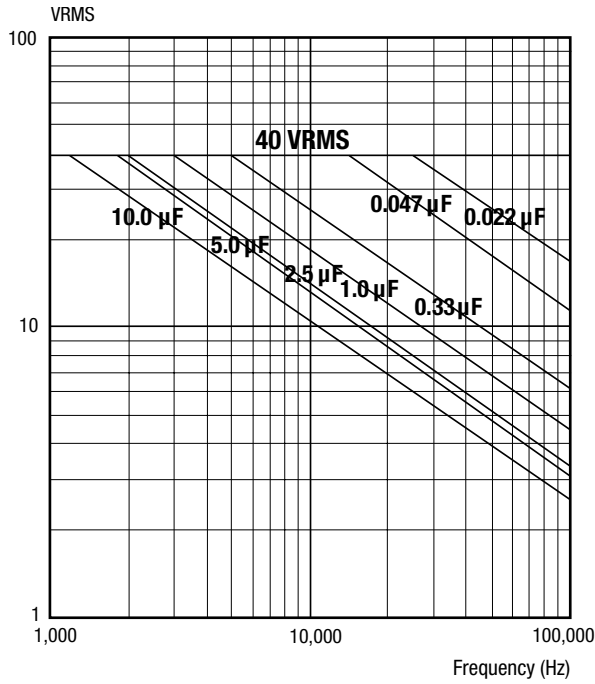

VOLTAGE VS. FREQUENCY TYPE 832P
100 VDC / 63 VAC

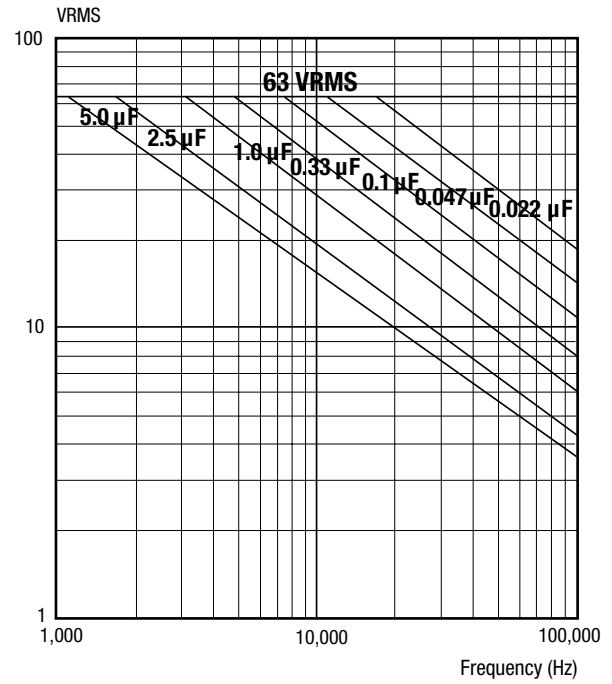

VOLTAGE VS. FREQUENCY TYPE 832P
250 VDC / 160 VAC

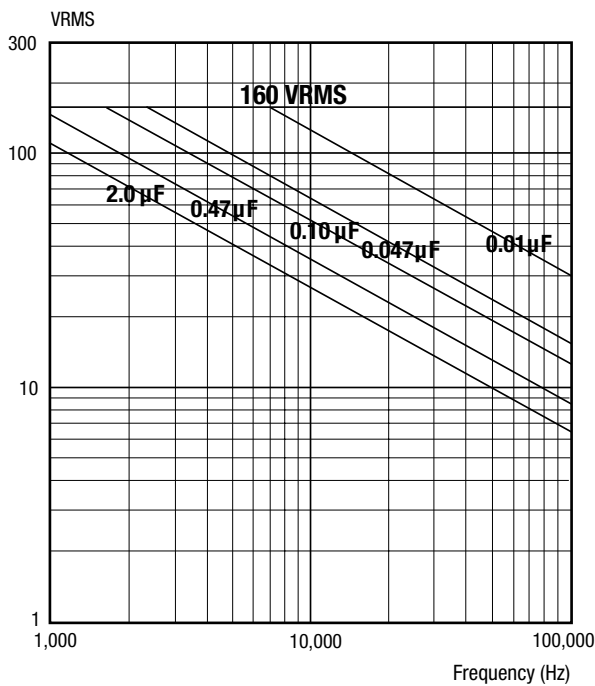

VOLTAGE VS. FREQUENCY TYPE 832P
400 VDC / 200 VAC

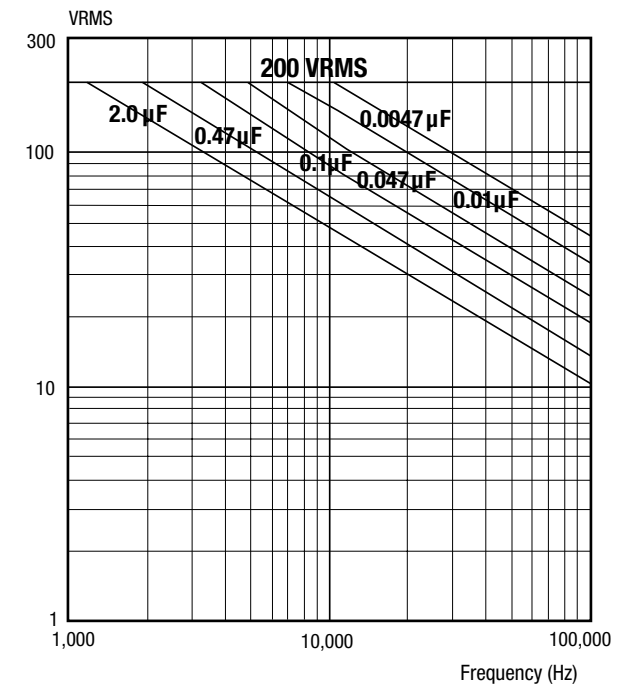

WRAP-AND-FILL METALIZED POLYPHENYLENE SULFIDE FILM CAPACITORS



FEATURES

- Superior performance
- High efficiency
- High stability
- High reliability
- Rugged construction
- Small size
- Meets the requirements of MIL-PRF-55514 / 13

MAJOR APPLICATIONS:

Filtering, timing, storage, integrating, and other applications requiring the high stability and low retrace of polyphenylene sulfide.

PHYSICAL CHARACTERISTICS

CONSTRUCTION:

Non-inductive wound metalized polyphenylene sulfide.

CASE: Flame retardant tape wrap and epoxy endfill.

LEAD MATERIAL: Solder coated solid wire.

LEAD WIRE SIZES:

Case Dia.	Lead AWG
< 0.230	0.020 (No. 24)
< 0.440	0.025 (No. 22)
≥ 0.440	0.032 (No. 20)

LEAD STRENGTH:

Capable of withstanding a five pound pull force on lead axis.

MARKING:

Dearborn trademark, type or catalog number, capacitance, tolerance and voltage.

ELECTRICAL SPECIFICATIONS

CAPACITANCE RANGE: 0.01 μ F to 15.0 μ F

VOLTAGE RATING:

- 50 VDC to 200 VDC
- 32 VRMS to 126 VRMS

CAPACITANCE TOLERANCE: \pm 10%, \pm 5%, \pm 2%

OPERATING TEMPERATURE:

-55°C to +125°C without derating for DC operation

AC OPERATION: Limited to +105°C

DISSIPATION FACTOR: 0.15% maximum when measured at 1kHz @ 25°C

DC VOLTAGE TEST: 200% of rated voltage for 2 minutes

INSULATION RESISTANCE:

Measure at rated VDC after a 2 minute charge.

- At + 25°C, 50,000 Megaohm-Microfarads, need not exceed 100,000 Megaohms
- At + 85°C, 2,000 Megaohm-Microfarads, need not exceed 4,000 Megaohms
- At + 125°C, 250 Megaohm-Microfarads, need not exceed 500 Megaohms

MAXIMUM PULSE RISE TIME

Capacitor Length (inch)	Rise Time dv / dt (V / μ s)		
	50 V	100 V	200 V
0.400	25	35	57
0.530	13	20	38
0.750	7	14	20
1.030	6	9	14
1.250	4	7	11
1.500	-	-	9

DIMENSIONS (in inches)

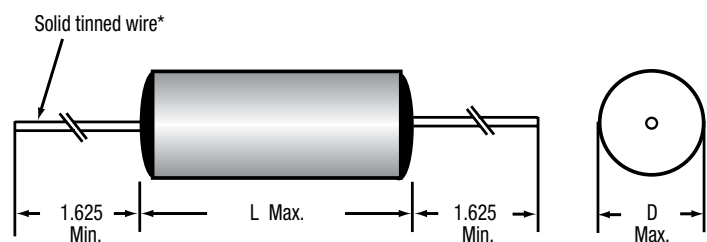

* Leads to be within ± 0.062 " of center line at egress, but not less than 0.031" from edge.

WRAP-AND-FILL METALIZED POLYPHENYLENE SULFIDE FILM CAPACITORS

TYPE 842P

STANDARD RATINGS

Capacitance		Voltage Code 050 50 VDC / 32 VAC*		Voltage Code 100 100 VDC / 63 VAC*		Voltage Code 200 200 VDC / 126 VAC*	
µF	Code	D	L	D	L	D	L
0.010	103	0.17	0.40	0.17	0.40	0.17	0.40
0.015	153	0.17	0.40	0.17	0.40	0.19	0.40
0.022	223	0.17	0.40	0.17	0.40	0.23	0.40
0.033	333	0.17	0.40	0.19	0.40	0.26	0.40
0.047	473	0.17	0.40	0.23	0.40	0.23	0.53
0.068	683	0.17	0.40	0.26	0.40	0.26	0.53
0.10	104	0.23	0.40	0.23	0.53	0.31	0.53
0.15	154	0.23	0.40	0.26	0.53	0.31	0.75
0.22	224	0.26	0.40	0.31	0.53	0.35	0.75
0.33	334	0.26	0.53	0.35	0.53	0.40	0.75
0.47	474	0.31	0.53	0.31	0.75	0.40	1.03
0.68	684	0.35	0.53	0.35	0.75	0.44	1.03
1.00	105	0.31	0.75	0.40	0.75	0.49	1.25
1.50	155	0.35	0.75	0.40	1.03	0.56	1.25
2.00	205	0.40	0.75	0.44	1.03	0.56	1.50
2.70	275	0.35	1.03	0.51	1.03	0.67	1.50
3.00	305	0.40	1.03	0.49	1.25	0.67	1.50
3.90	395	0.44	1.03	0.56	1.25	0.76	1.50
5.00	505	0.49	1.03	0.61	1.25	0.87	2.06
5.60	565	0.49	1.03	0.56	1.50	-	-
6.80	685	0.49	1.25	0.61	1.50	-	-
10.00	106	0.61	1.25	-	-	-	-
15.00	156	0.61	1.50	-	-	-	-

Additional capacitance values, voltages, and tolerances are available upon request.

* AC voltage rating is at 400Hz 1.4 x VRMS + VDC should not exceed the rated VDC.

* Graphs of AC voltage vs. frequency follow.

WRAP-AND-FILL METALIZED POLYPHENYLENE SULFIDE FILM CAPACITORS

VOLTAGE VS. FREQUENCY TYPE 842P

50 VDC / 32 VAC

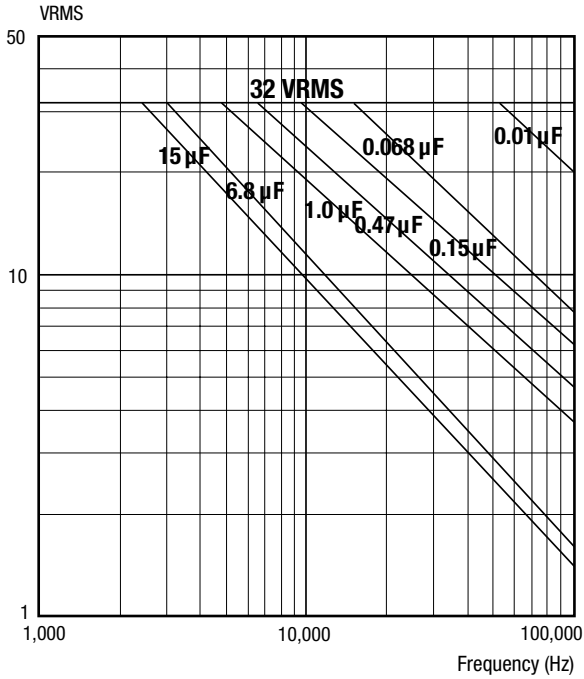

VOLTAGE VS. FREQUENCY TYPE 842P

100 VDC / 63 VAC

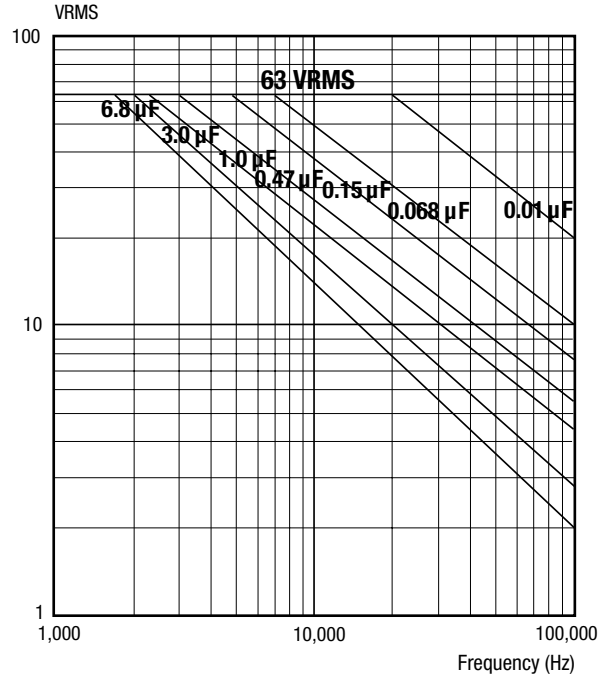

VOLTAGE VS. FREQUENCY TYPE 842P

200 VDC / 126 VAC

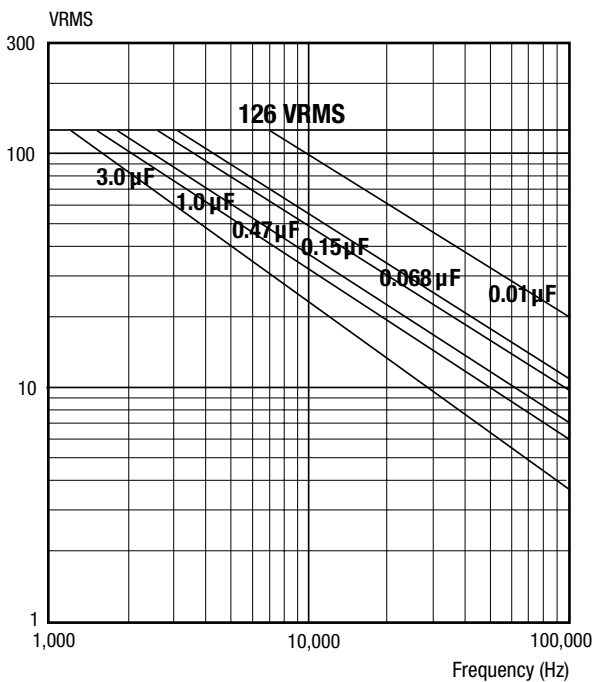

WRAP-AND-FILL METALIZED POLYPHENYLENE SULFIDE FILM CAPACITORS

TYPE 880P



FEATURES

- High temperature to +150°C
- Close tolerances
- Rugged / lightweight
- Extensive standard ratings

MAJOR APPLICATIONS:

Timing, feedback circuits, filtering, decoupling.

PHYSICAL CHARACTERISTICS

CONSTRUCTION:

Non-inductive wound metalized polyphenylene sulfide.

CASE: Flame retardant tape wrap and epoxy endfill.

LEAD MATERIAL: Solder coated solid wire.

LEAD WIRE SIZES:

Case Dia.	Lead AWG
< 0.200	0.020 (No. 24)
0.200 - 0.300	0.025 (No. 22)
0.301 - 0.500	0.032 (No. 20)
> 0.500	0.040 (No. 18)

LEAD STRENGTH:

Capable of withstanding a five pound pull force on lead axis.

MARKING:

Dearborn trademark, type or catalog number, capacitance, tolerance and voltage.

ELECTRICAL SPECIFICATIONS

CAPACITANCE RANGE: 0.0047 μ F to 10.0 μ F

VOLTAGE RATING:

- 50 VDC to 400 VDC
- 32 VRMS to 240 VRMS

CAPACITANCE TOLERANCE: \pm 10%, \pm 5%, \pm 2%

OPERATING TEMPERATURE:

-55°C to +150°C without derating for DC operation AC operation limited to +125°C

DISSIPATION FACTOR: 0.15% max. when measured at 1kHz @ 25°C

DC VOLTAGE TEST: 200% of rated voltage for 1 min.

INSULATION RESISTANCE:

Measured at rated VDC after a 2 minute charge.

- At +25°C, 100,000 Megaohm-Microfarads, need not exceed 200,000 Megaohms
- At +85°C, 2,000 Megaohm-Microfarads, need not exceed 4,000 Megaohms
- At +125°C, 250 Megaohm-Microfarads, need not exceed 500 Megaohms
- At +150°C, 10 Megaohm-Microfarads, need not exceed 100 Megaohms

MAXIMUM PULSE RISE TIME

Capacitor Length (inch)	Rise Time dv / dt (V / μ s)			
	50 V	100 V	200 V	400 V
0.400	25	35	57	100
0.530	13	20	38	65
0.750	7	14	20	35
1.030	6	9	14	20
1.250	4	7	11	17
1.500	-	-	9	15
1.750	-	-	-	10

DIMENSIONS (in inches)

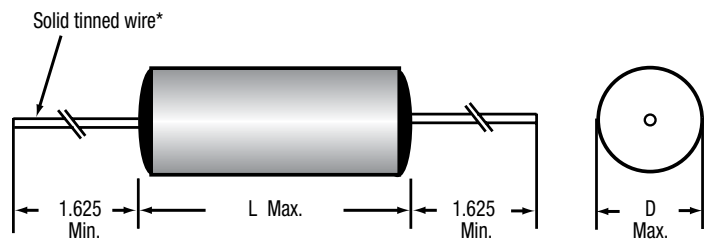

* Leads to be within \pm 0.062" of center line at egress, but not less than 0.031" from edge.

WRAP-AND-FILL METALIZED POLYPHENYLENE SULFIDE FILM CAPACITORS

STANDARD RATINGS

Capacitance		Voltage Code 050 50 VDC / 32 VAC*		Voltage Code 100 100 VDC / 63 VAC*		Voltage Code 200 200 VDC / 126 VAC*		Voltage Code 400 400 VDC / 240 VAC*	
μF	Code	D	L	D	L	D	L	D	L
0.0047	472	-	-	-	-	0.170	0.400	-	-
0.0068	682	-	-	-	-	0.170	0.400	-	-
0.010	103	0.170	0.400	0.170	0.400	0.170	0.400	0.260	0.400
0.015	153	0.170	0.400	0.170	0.400	0.190	0.400	0.260	0.530
0.022	223	0.170	0.400	0.170	0.400	0.230	0.400	0.310	0.530
0.033	333	0.170	0.400	0.190	0.400	0.230	0.400	0.390	0.530
0.047	473	0.170	0.400	0.230	0.400	0.260	0.400	0.350	0.750
0.068	683	0.170	0.400	0.230	0.400	0.260	0.530	0.400	1.030
0.10	104	0.190	0.400	0.260	0.400	0.350	0.530	0.400	1.030
0.15	154	0.230	0.400	0.260	0.400	0.310	0.750	0.490	1.030
0.22	224	0.260	0.400	0.260	0.530	0.350	0.750	0.490	1.250
0.33	334	0.260	0.530	0.350	0.530	0.350	1.030	0.490	1.500
0.47	474	0.310	0.530	0.310	0.750	0.400	1.030	0.610	1.500
0.68	684	0.310	0.530	0.350	0.750	0.490	1.030	0.670	1.750
1.00	105	0.310	0.750	0.440	0.750	0.490	1.250	0.740	1.750
1.50	155	0.350	0.750	0.440	1.030	0.560	1.250	-	-
2.00	205	0.400	0.750	0.490	1.030	0.560	1.500	-	-
2.70	275	0.350	1.030	0.560	1.030	0.670	1.500	-	-
3.00	305	0.350	1.030	0.490	1.250	0.670	1.500	-	-
4.00	405	0.440	1.030	0.610	1.250	-	-	-	-
5.00	505	0.490	1.030	0.610	1.250	-	-	-	-
6.80	685	0.490	1.250	-	-	-	-	-	-
8.00	805	0.560	1.250	-	-	-	-	-	-
10.00	106	0.610	1.250	-	-	-	-	-	-

Additional capacitance values, voltages, and tolerances are available upon request.
 * AC voltage rating is at 400Hz 1.4 x VRMS + VDC should not exceed the rated VDC.

TYPICAL CHARACTERISTICS PPS FILM / FOIL TYPES

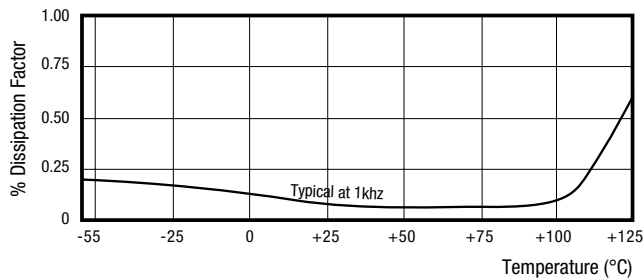
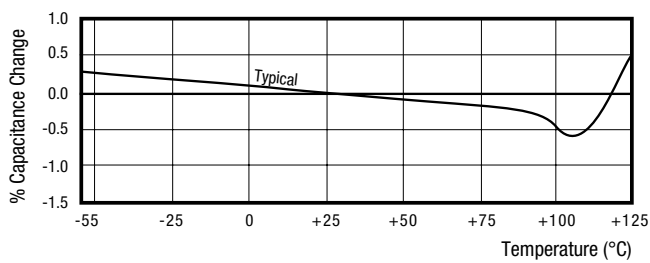

IR VS. TEMPERATURE

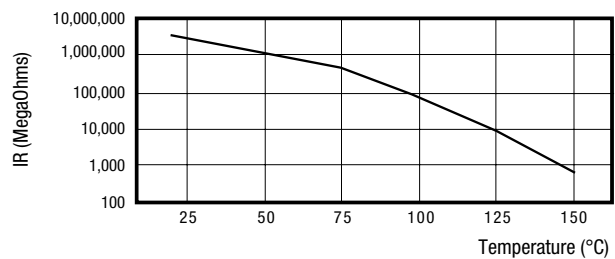

METALLIZED POLYPHENYLENE SULFIDE FILM CAPACITORS SMD

TYPE DKM 94



PHYSICAL CHARACTERISTICS

CONSTRUCTION:

Dielectric: metallized Polyethylene Sulfide (PPS).

CASE:

Self healing, non-inductive. Epoxy resin molded surface mount device (SMD).

MARKING:

Dearborn trademark, type or catalog number, capacitance, tolerance and voltage.

CASE SIZE CODE TABLE

Code	L-Max.	E-Max.	H-Max.	R + / - 0.008	S + / - 0.008
-1	0.315	0.295	0.177	0.158	0.04
-2	0.315	0.335	0.295	0.158	0.04
-3	0.421	0.421	0.295	0.197	0.06

ELECTRICAL SPECIFICATIONS

OPERATING TEMPERATURE RANGE:

-55°C to +125°C

DISSIPATION FACTOR (DF):

≤ 0.2% @ 1kHz

INSULATION RESISTANCE (IR):

≥ 30,000 MΩ for $C_R \leq 0.33 \mu\text{F}$

≥ 10,000 MΩ.μF for $C_R \leq 0.33 \mu\text{F}$

INSULATION BETWEEN LEADS & CASE:

≥ 30,000 MΩ

DIMENSIONS (in inches)

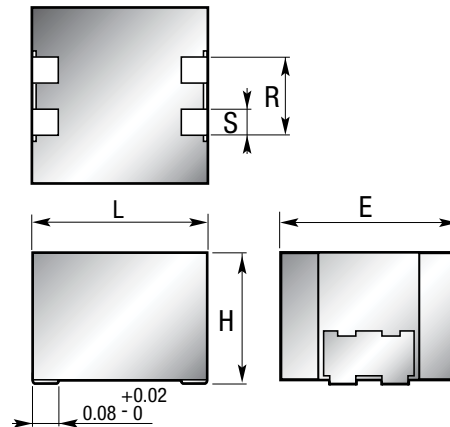

METALLIZED POLYPHENYLENE SULFIDE FILM CAPACITORS SMD

STANDARD RATINGS

Capacitance		Type DKM 94		
μF	Code	40 VDC	50 VDC	100 VDC
0.0047	472	-1	-1	-1
0.0068	682	-1	-1	-1
0.0082	822	-1	-1	-1
0.01	103	-1	-1	-1
0.012	123	-1	-1	-1
0.015	153	-1	-1	-1
0.018	183	-1	-1	-1
0.02	203	-1	-1	-1
0.022	223	-1	-1	-1
0.033	333	-1	-1	-1
0.039	393	-1	-1	-1
0.047	473	-1	-1	-1
0.068	683	-1	-1	-1
0.082	823	-1	-1	-1
0.1	104	-1	-1	-1
0.15	154	-1	-1	-2
0.22	224	-1	-1	-2
0.33	334	-2	-2	-3
0.47	474	-2	-2	-3
0.5	504	-	-	-
0.56	564	-	-	-
0.68	684	-3	-3	-
1	105	-3	-3	-
1.2	125	-3	-	-

ORDERING EXAMPLE:

*DKM94-1333X9050

Tolerances available: +/-20%=X0
 +/-10%=X9
 +/-5%=X5
 +/-2%=X2
 +/-1%=X1

WRAP AND FILL SMALL SIZE POLYPHENYLENE SULFIDE DIELECTRIC FILM / FOIL CONSTRUCTION

TYPE 810P



FEATURES

- Extended foil construction
- + 125°C rated
- Replacement for 610P polycarbonate capacitors
- Moisture resistant
- Low dissipation factor

MAJOR APPLICATIONS:

Oscillator, timing, coupling and decoupling at high frequency, filter circuits.

PHYSICAL CHARACTERISTICS

CONSTRUCTION:

Non-inductive wound polyphenylene sulfide film and extended foil.

CASE:

Flame retardant tape wrap and epoxy endfill.

LEAD MATERIAL:

Solder coated solid wire.

LEAD WIRE SIZES:

Case Dia.	Lead AWG
≤ 0.327	0.025 (No. 22)
> 0.327	0.032 (No. 20)

LEAD STRENGTH:

Capable of withstanding a five pound pull force on lead axis.

MARKING:

Dearborn trademark, type or catalog number, capacitance, tolerance and voltage.

ELECTRICAL SPECIFICATIONS

CAPACITANCE RANGE: 0.001 μ F to 1.0 μ F

DC VOLTAGE RATING: 50 VDC to 400 VDC

CAPACITANCE TOLERANCE: \pm 20%, \pm 10%, \pm 5%

OPERATING TEMPERATURE: -55°C to +125°C

VOLTAGE DERATING: At +125°C, 50% of the +85°C rating

DISSIPATION FACTOR:

0.15% maximum when measured at 1kHz @ 25°C

VOLTAGE TEST: 200% of rated voltage for 1 minute

INSULATION RESISTANCE:

Measured at rated VDC after a 2 minute charge.

- At +25°C, 50,000 Megaohm-Microfarads, need not exceed 100,000 Megaohms
- At +85°C, 2,000 Megaohm-Microfarads, need not exceed 4,000 Megaohms
- At +125°C, 250 Megaohm-Microfarads, need not exceed 500 Megaohms

MAXIMUM PULSE RISE TIME

Capacitor Length (inch)	Rise Time dv / dt (V / μ s)			
	50 V	100 V	200 V	400 V
0.560	3200	3700	4400	6000
0.625	1300	-	-	3617
0.750	630	1200	1727	2900
1.000	-	680	1147	1636
1.062	470	-	1100	1500
1.250	440	-	-	1100
1.312	-	727	-	1000
1.562	-	433	-	900
1.812	270	368	578	-
2.062	-	-	442	612
2.312	-	300	-	-
2.562	-	-	-	491

DIMENSIONS (in inches)

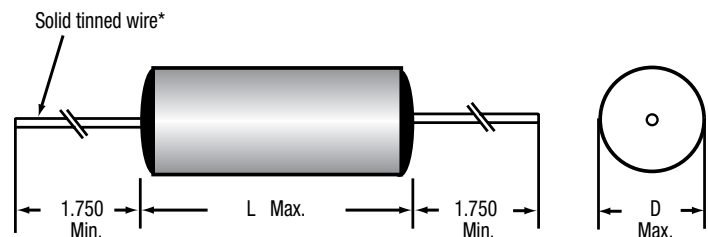

* Leads to be within \pm 0.062" of center line at egress, but not less than 0.031" from edge.

WRAP AND FILL SMALL SIZE POLYPHENYLENE SULFIDE DIELECTRIC FILM / FOIL CONSTRUCTION

STANDARD RATINGS

Capacitance		Voltage Code 050 50 VDC		Voltage Code 100 100 VDC		Voltage Code 200 200 VDC		Voltage Code 400 400 VDC	
μ F	Code	D	L	D	L	D	L	D	L
0.0010	102	0.260	0.560	0.260	0.560	0.260	0.560	0.260	0.560
0.0015	152	0.260	0.560	0.260	0.560	0.260	0.560	0.260	0.560
0.0022	222	0.260	0.560	0.260	0.560	0.260	0.560	0.327	0.560
0.0033	332	0.260	0.560	0.260	0.560	0.260	0.560	0.327	0.560
0.0047	472	0.327	0.560	0.327	0.560	0.327	0.560	0.312	0.625
0.0068	682	0.327	0.560	0.327	0.560	0.327	0.560	0.312	0.750
0.010	103	0.235	0.625	0.340	0.560	0.312	0.750	0.400	0.750
0.015	153	0.235	0.625	0.312	0.750	0.312	0.750	0.400	1.000
0.022	223	0.235	0.750	0.312	0.750	0.400	0.750	0.400	1.250
0.033	333	0.312	0.750	0.312	0.750	0.400	1.000	0.500	1.000
0.047	473	0.312	0.750	0.400	0.750	0.400	1.000	0.562	1.062
0.068	683	0.400	0.750	0.400	1.000	0.500	1.000	0.562	1.312
0.10	104	0.400	0.750	0.400	1.000	0.562	1.062	0.670	1.562
0.15	154	0.400	1.250	0.562	1.312	0.562	1.812	0.750	2.062
0.22	224	0.562	1.062	0.562	1.562	0.670	1.812	0.750	2.562
0.33	334	0.562	1.062	0.670	1.562	0.750	2.062	1.000	2.062
0.47	474	0.562	1.812	0.750	1.812	1.000	1.812	1.000	2.562
0.68	684	0.562	1.812	0.750	2.312	-	-	-	-
1.00	105	0.750	1.812	1.000	1.812	-	-	-	-

Additional capacitance values, voltages, and tolerances are available upon request.

WRAP-AND-FILL ZERO TCC POLYPHENYLENE SULFIDE FILM / FOIL CAPACITORS

TYPE 882P



FEATURES

- High current Capacity
- Close tolerances
- Low losses

MAJOR APPLICATIONS:

Critical timing, sample and hold, high stability.

PHYSICAL CHARACTERISTICS

CONSTRUCTION:

Non-inductive wound polyphenylene sulfide film and extended foil.

CASE:

Flame retardant tape wrap and epoxy endfill.

LEAD MATERIAL:

Solder coated solid wire.

LEAD WIRE SIZES:

Case Dia.	Lead AWG
< 0.270	0.025 (No. 22)
≥ 0.270	0.032 (No. 20)

LEAD STRENGTH:

Capable of withstanding a five pound pull force on lead axis.

MARKING:

Dearborn trademark, type or catalog number, capacitance, tolerance and voltage.

ELECTRICAL SPECIFICATIONS

CAPACITANCE RANGE: 0.001 μ F to 0.22 μ F

VOLTAGE RATING: 200 VDC

CAPACITANCE TOLERANCE: \pm 10%, \pm 5%, \pm 2%

OPERATING TEMPERATURE: -55°C to +125°C, without derating

DISSIPATION FACTOR: 0.15% maximum

DC VOLTAGE TEST: 250% of rated voltage for 15 seconds

INSULATION RESISTANCE:

Measured at rated VDC after a 2 minute charge.

- At +25°C, 100,000 Megaohm-Microfarads, need not exceed 200,000 Megaohms

DIMENSIONS (in inches)

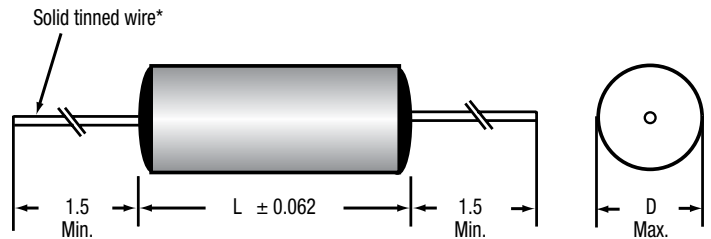

WRAP-AND-FILL ZERO TCC POLYPHENYLENE SULFIDE FILM / FOIL CAPACITORS

STANDARD RATINGS

Capacitance		Voltage Code 200 200 VDC	
μF	Code	D	L
0.0010	102	0.210	0.438
0.0015	152	0.210	0.438
0.0022	222	0.210	0.438
0.0033	332	0.210	0.438
0.0047	472	0.210	0.438
0.0068	682	0.210	0.438
0.010	103	0.220	0.438
0.015	153	0.220	0.625
0.022	223	0.250	0.625
0.033	333	0.280	0.625
0.047	473	0.320	0.625
0.068	683	0.300	0.750
0.10	104	0.350	0.750
0.15	154	0.330	1.000
0.22	224	0.380	1.000

Additional capacitance values, voltages, and tolerances are available upon request.

ENERGY STORAGE CAPACITORS

METALIZED FILM

Type 282P.....	152
Type 681P.....	154
Type 682P.....	156
Type 684P.....	157



METALIZED-FILM ENERGY STORAGE CAPACITORS



FEATURES

- Half the size and a third the weight of conventional paper energy storage capacitors
- High energy (up to 1,600 Joules)
- High current (up to 3,000 Amps)
- Rectangular metal case construction

MAJOR APPLICATIONS:

Lasers, beacons, flash, and other applications requiring small, lightweight energy storage capacitors. These capacitors are designed to discharge into lamp loads at 1 pps or less at ambient temperatures up to 40°C.

PHYSICAL CHARACTERISTICS

CONSTRUCTION:

Non-inductive wound metalized film, wax impregnated.

CASE:

Hermetically sealed, drawn or welded, rectangular cases, for maximum durability.

MARKING:

Dearborn trademark, type or catalog number, capacitance, tolerance and voltage.

SPECIAL REQUIREMENTS:

The operational characteristics as stated are typical of standard capacitors. Special designs to meet additional or different requirements are available. Consult factory for additional information.

ELECTRICAL SPECIFICATIONS

CAPACITANCE RANGE:

10 μ F to 200 μ F

CAPACITANCE TOLERANCE:

+20% -10%, \pm 10%

OPERATING TEMPERATURE:

0°C to +40°C

DC VOLTAGE RANGE:

2,000 VDC to 4,000 VDC

DISSIPATION FACTOR:

1.0% maximum

VOLTAGE TEST:

120% of rated voltage for 2 minutes

DISCHARGE RATE:

1 discharge per sec. maximum

INDUCTANCE:

The typical inductance at the resonant frequency is 0.1 μ H

INSULATION RESISTANCE:

Measured at 500 VDC after a 2 minute charge.

- At +25°C, 2,000 Megaohm-Microfarads

DIMENSIONS (in inches)

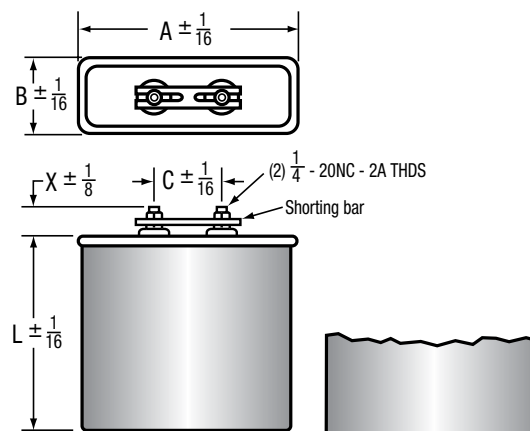

FIGURE 1
DRAWN CASE

FIGURE 1A
WELDED CASE

METALIZED-FILM ENERGY STORAGE CAPACITORS

TYPE 282P

STANDARD RATINGS

μF	Rated Joules	Catalog Number	Figure Number	Dimensions (in inches)					Energy Density (in Joules / in ³)	Approx. Weight (in lbs)
				A	B	C	L	X		
2,000 VDC										
50	100	282P1	1	3.75	2.5	2	5.875	0.625	1.84	2.6
80	160	282P2	1	4.5625	3.75	2	5.125	0.625	1.83	4.1
100	200	282P3	1	4.5625	3.75	2	6.25	0.625	1.87	5.0
200	400	282P4	1A	8	4.125	4.625	6.5	0.5	1.87	10.5
2,500 VDC										
10	31	282P5	1	3.75	2.25	2	3.375	0.625	1.0	1.5
20	62	282P6	1	3.75	2.25	2	4.75	0.625	1.55	1.9
50	156	282P7	1	4.5625	3.75	2	5.125	0.625	1.78	4.1
80	250	282P8	1	4.5625	3.75	2	6.75	0.625	2.18	5.4
100	312	282P9	1A	8	4.125	4.625	5.125	0.5	1.85	8.3
200	625	282P10	1A	8	4.125	4.625	8.75	0.5	2.17	14.2
4,000 VDC										
25	200	282P11	1	4.5625	3.75	2	6.25	0.625	1.87	5.0
35	280	282P12	1	4.5625	3.75	2	7.75	0.625	2.12	6.3
50	400	282P13	1A	8	4.125	4.625	6.5	0.5	1.87	10.5
100	800	282P14	1A	8	4.125	4.625	10.25	0.5	2.37	16.5
200	1600	282P15	1A	13.5	5.25	6.75	10.375	0.5	2.18	34.5

Additional capacitance values, voltages, and tolerances are available upon request.

HIGH DISCHARGE RATE ENERGY-STORAGE METALIZED-FILM CAPACITORS



- DISCHARGE RATE:** 10 discharges per sec. maximum
- INDUCTANCE:** 0.03 to 0.05 μ H typical at resonance (terminal style 1 only)
- INSULATION RESISTANCE:**
Measured at 500 VDC after a 2 minute charge.
 - At +25°C, 5,000 Megaohm-Microfarads

DIMENSIONS (in inches / mm)

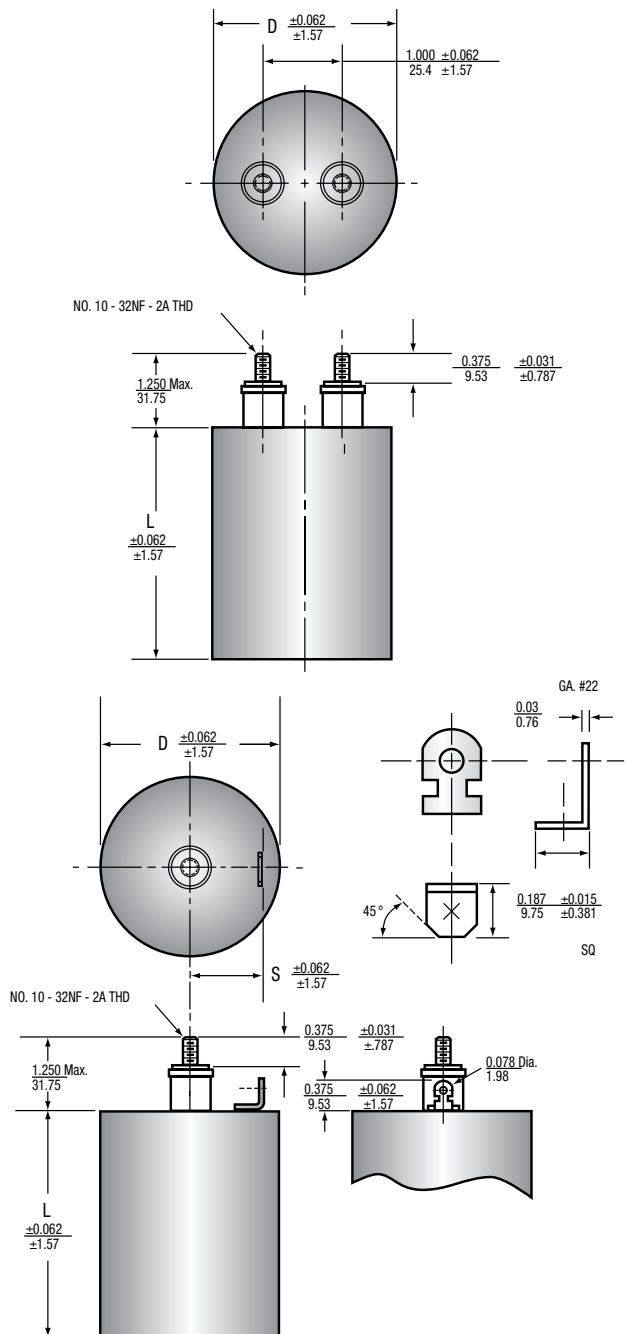

FEATURES

- High energy density
- Metal tubular case
- Lightweight
- 5 joules / cu. in.
- 80 joules / pound

MAJOR APPLICATIONS:

Flash, laser, strobe, beacons.

PHYSICAL CHARACTERISTICS

CONSTRUCTION:

Non-inductive wound proprietary composition dielectric, silicone oil impregnated

CASE:

Hermetically sealed drawn cylindrical enclosure. Available with case grounded (1 terminal) and insulated case (2 terminals).

MARKING:

Dearborn trademark, type or catalog number, capacitance, tolerance and voltage.

SPECIAL REQUIREMENTS:

The operational characteristics as stated are typical of standard capacitors. Special designs to meet additional or different requirements are available. Consult factory for additional information.

ELECTRICAL SPECIFICATIONS

CAPACITANCE RANGE: 5 μ F to 100 μ F

CAPACITANCE TOLERANCE: +20% -10%, $\pm 10\%$

OPERATING TEMPERATURE: 0°C to +40°C

DC VOLTAGE RANGE: 1,000 VDC to 2,500 VDC

DISSIPATION FACTOR: 1.0% maximum

VOLTAGE TEST: 120% of rated voltage for 2 minutes

HIGH DISCHARGE RATE ENERGY-STORAGE METALIZED-FILM CAPACITORS

TYPE 681P

DIMENSIONS

Case Code	Inches			Millimeters*		
	D	L	S	D	L	S
DE	1.375	2.500	0.562	34.9	63.5	14.27
DG	1.375	3.500	0.562	34.9	88.9	14.27
EE	1.500	2.500	0.680	38.1	63.5	17.27
EG	1.500	3.500	0.680	38.1	88.9	17.27
FG	1.625	3.500	0.750	41.3	88.9	19.10
FJ	1.625	4.500	0.750	41.3	114.3	19.10
JG	2.000	3.500	0.750	50.8	88.9	19.10
JJ	2.000	4.500	0.750	50.8	114.3	19.10
LJ	2.250	4.500	0.750	57.2	114.3	19.10
NJ	2.500	4.500	0.750	63.5	114.3	19.10

* Based on 1" = 25.4 mm.

TYPICAL WEIGHT

Case Code	Ounces	Grams
DE	3.6	102
DG	5.1	145
EE	4.4	125
EG	6.1	173
FG	7.2	204
FJ	9.2	261
JG	11	312
JJ	14	397
LJ	18	510
NJ	22	624

STANDARD RATINGS

µF	Rated Joules	Grounded Number		Case Code	Max. Peak Discharge Current (in Amps)	Energy Density (in Joules/in ³)
		Grounded Case	Insulated Case			
1,000 VDC						
20	10	681P206B21K01	-	EE	585	2.28
30	15	681P306B21K01	-	EG	585	2.42
50	25	681P506B21K01	-	FJ	645	2.69
80	40	681P806B21K01	681P806B21K02	JJ	1040	2.86
100	50	681P107B21K01	681P107B21K02	LJ	1330	2.78
1,500 VDC						
10	11	681P106B21K51	-	EE	400	2.50
20	23	681P206B21K51	-	EG	460	3.71
30	34	681P306B21K51	-	FJ	505	3.66
50	56	681P506B21K51	681P506B21K52	JJ	810	4.00
60	68	681P606B21K51	681P606B21K52	LJ	1040	3.78
80	90	681P806B21K51	681P806B21K52	NJ	1360	4.09
2,000 VDC						
5	10	681P505B22K01	-	DE	250	2.70
10	20	681P106B22K01	-	DG	290	3.85
20	40	681P206B22K01	681P206B22K02	JG	635	3.64
30	60	681P306B22K01	681P306B22K02	JJ	635	4.29
50	100	681P506B22K01	681P506B22K02	NJ	1080	4.55
2,500 VDC						
5	16	681P505B22K51	-	EE	310	3.64
10	31	681P106B22K51	-	FG	340	4.25
15	47	681P156B22K51	681P156B22K52	JG	550	4.27
20	63	681P206B22K51	681P206B22K52	JJ	550	4.50
35	110	681P356B22K51	681P356B22K52	NJ	930	5.00

Additional capacitance values, voltages, and tolerances are available upon request.

HIGH DISCHARGE RATE ENERGY-STORAGE METALIZED POLYPROPYLENE FILM CAPACITORS



FEATURES

- Low cost and weight
- 10 PPS discharge rate
- Rugged wrap & fill construction
- Low loss

MAJOR APPLICATIONS: Flash, portable laser, hand held range finder.

PHYSICAL CHARACTERISTICS

CONSTRUCTION: Non-inductive wound metalized polypropylene.

CASE: Flame retardant tape wrap and epoxy endfill.

LEAD MATERIAL: Solder coated copper wire No. 16 AWG.

LEAD STRENGTH: Capable of withstanding a five pound pull force on lead axis.

SPECIAL REQUIREMENTS:

The operational characteristics as stated are typical of standard capacitors. Special designs to meet additional or different requirements are available. Consult factory for additional information.

MARKING:

Dearborn trademark, type or catalog number, capacitance, tolerance and voltage.

ELECTRICAL SPECIFICATIONS

CAPACITANCE RANGE: 5 μF to 100 μF

CAPACITANCE TOLERANCE: +20% -10%, $\pm 10\%$

OPERATING TEMPERATURE: 0°C to +40°C

DC VOLTAGE RANGE: 800 VDC to 1,200 VDC

DISSIPATION FACTOR: 0.3% maximum

VOLTAGE TEST: 150% of rated voltage for 2 minutes

DISCHARGE RATE: 10 discharges per sec. maximum

INDUCTANCE: 0.03 to 0.05 μH typical at resonance

INSULATION RESISTANCE:

Measured at 500 VDC after a 2 minute charge.

- At +25°C, 40,000 Megaohm-Microfarads

DIMENSIONS (in inches)

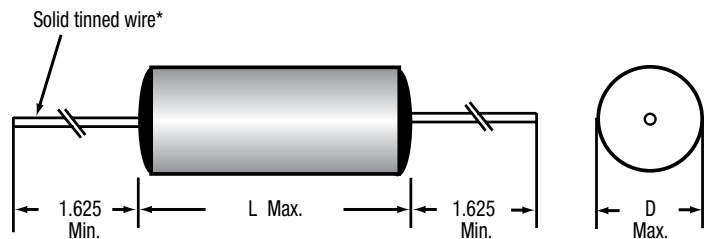

STANDARD RATINGS

μF	Rated Joules	Dimensions (in inches)		Max. Peak Discharge Current (in Amps)
		D Max.	L Max.	
800 VDC				
10	3.2	1.147	2.531	150
25	8	1.688	2.531	350
50	16	2.309	2.531	700
75	24	2.264	3.515	700
100	32	2.243	4.499	700
1,000 VDC				
10	5	1.524	2.531	200
25	12.5	2.296	2.531	500
50	25	2.164	4.499	500
1,200 VDC				
5	3.6	1.364	2.531	100
10	7.2	1.843	2.531	250
25	18	2.232	3.515	400

HIGH DISCHARGE RATE ENERGY-STORAGE METALIZED POLYESTER FILM CAPACITORS

TYPE 684P



FEATURES

- Low cost
- Light weight
- 10 PPS discharge rate
- Rugged wrap & fill construction
- Long life

MAJOR APPLICATIONS:

Flash, laser, strobe, light bar, aluminum electrolytic alternative.

PHYSICAL CHARACTERISTICS

CONSTRUCTION:

Non-inductive wound metalized polyester.

CASE:

Flame retardant tape wrap and epoxy endfill.

LEAD MATERIAL:

Solder coated copper wire No. 16 AWG.

LEAD STRENGTH:

Capable of withstanding a five pound pull force on lead axis.

MARKING:

Dearborn trademark, type or catalog number, capacitance, tolerance and voltage.

ELECTRICAL SPECIFICATIONS

CAPACITANCE RANGE:

5 μF to 175 μF

CAPACITANCE TOLERANCE:

+20% -10%, $\pm 10\%$

OPERATING TEMPERATURE:

0°C to +40°C

DC VOLTAGE RANGE:

400 VDC to 1,000 VDC

DISSIPATION FACTOR:

1.0% maximum

VOLTAGE TEST:

150% of rated voltage for 2 minutes

DISCHARGE RATE:

10 discharge per sec. maximum

INDUCTANCE:

0.03 to 0.05 μH typical at resonance

INSULATION RESISTANCE:

Measure at rated voltage, not to exceed 500 VDC, after a 2 minute charge.

- At +25°C, 25,000 Megaohm-Microfarads

DIMENSIONS (in inches)

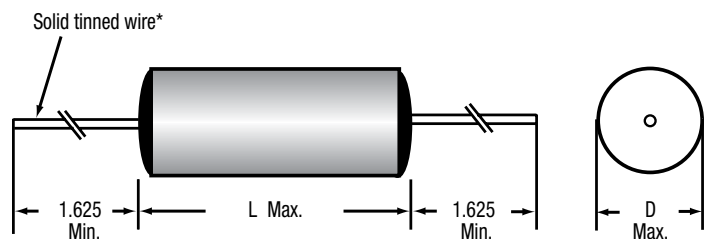

HIGH DISCHARGE RATE ENERGY-STORAGE METALIZED POLYPROPYLENE FILM CAPACITORS

STANDARD RATINGS

μF	Rated Joules	Dimensions (in inches)		Max. Peak Discharge Current (in Amps)
		D Max.	L Max.	
400 VDC				
5.0	0.4	0.807	2.062	65
10.0	0.8	1.032	2.062	130
25.0	2	1.502	2.062	300
50.0	4	2.043	2.062	600
75.0	6	2.148	2.531	700
100.0	8	1.759	4.500	450
150.0	12	2.112	4.500	700
175.0	14	2.267	4.500	800
750 VDC				
10.0	2.8	1.204	2.062	160
25.0	7.0	1.782	2.062	400
50.0	14	2.100	2.562	550
75.0	21.1	2.078	3.515	550
100.0	28.1	2.060	4.500	550
1,000 VDC				
10.0	5	1.573	2.062	230
25.0	12.5	2.015	2.531	400
50.0	25.0	2.211	3.515	500
75.0	37.5	2.291	4.500	530

MICA CAPACITORS

Type DHT 78 and DHT 78P ⁽¹⁾	160
Type DHT 86 and DHT 86P ⁽¹⁾	165
Type DHT 96.....	171
Type DHT 97 and DHT 97P ⁽¹⁾	175



DEARBORN
ELECTRONICS INC.

MICA HIGH VOLTAGE CAPACITORS



PHYSICAL CHARACTERISTICS

CONSTRUCTION:

Metal foils, non-inductive.

CASE:

- Composite reconstituted mica
- Epoxy resin impregnated
- Polyester wrapped
- Epoxy resin sealed

MARKING:

Dearborn trademark, type or catalog number, capacitance, tolerance and voltage.

ELECTRICAL SPECIFICATIONS

OPERATING TEMPERATURE RANGE:

TYPE DHT 78: -55°C to +155°C

TYPE DHT 78P: -55°C to +125°C

DISSIPATION FACTOR:

$\leq 0.7\%$ @ 1kHz for $C_R \leq 1.5\text{nF}$

$\leq 0.5\%$ @ 1kHz for $C_R > 1.5\text{nF}$

INSULATION RESISTANCE (IR):

$\geq 25,000\text{ M}\Omega$ for $C_R \leq 0.22\text{ }\mu\text{F}$

$\geq 5,000\text{ M}\Omega\cdot\mu\text{F}$ for $C_R > 0.22\text{ }\mu\text{F}$

DIELECTRIC WITHSTANDING VOLTAGE (DWV):

1.6 x rated voltage

INSULATION BETWEEN LEADS & CASE:

25,000 M Ω

CAPACITANCE TOLERANCES AVAILABLE:

$\pm 20\%$, $\pm 10\%$, $\pm 5\%$

DIMENSIONS (in inches)

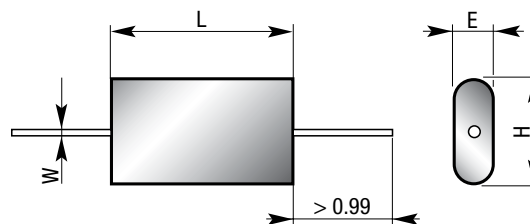

MICA HIGH VOLTAGE CAPACITORS

TYPE DHT 78 /
DHT 78P⁽¹⁾

STANDARD RATINGS

Capacitance		Dimensions (in inches)				TYPE DHT 78								
μF	Code	Max. "L"	Max. "E"	Max. "H"	"W" Gauge	630 V	1,000 V	1,500 V	2,500 V	3,500 V	5,000 V	7,500 V	10,000 V	
0.00033	331	1.457	0.197	0.472	18	DHT 78	DHT 78	DHT 78	DHT 78	DHT 78	DHT 78	DHT 78	DHT78	
0.00068	681	1.457	0.197	0.472	18	DHT 78	DHT 78	DHT 78	DHT 78	DHT 78	DHT 78	DHT 78	-	
0.0015	152	1.457	0.197	0.472	18	DHT 78	DHT 78	DHT 78	DHT 78	DHT 78	DHT 78	-	-	
0.0033	332	1.457	0.197	0.472	18	DHT 78	DHT 78	DHT 78	DHT 78	DHT 78	-	-	-	
0.0068	682	1.457	0.197	0.472	18	DHT 78	DHT 78	DHT 78	DHT 78	-	-	-	-	
0.01	103	1.457	0.197	0.472	18	DHT 78	DHT 78	DHT 78	-	-	-	-	-	
0.015	153	1.457	0.197	0.472	18	DHT 78	DHT 78	-	-	-	-	-	-	
0.022	223	1.457	0.197	0.472	18	DHT 78	-	-	-	-	-	-	-	
0.00047	471	1.457	0.276	0.551	18	DHT 78	DHT 78	DHT 78	DHT 78	DHT 78	DHT 78	DHT 78	DHT 78	
0.001	102	1.457	0.276	0.551	18	DHT 78	DHT 78	DHT 78	DHT 78	DHT 78	DHT 78	DHT 78	-	
0.022	222	1.457	0.276	0.551	18	DHT 78	DHT 78	DHT 78	DHT 78	DHT 78	DHT 78	-	-	
0.0047	472	1.457	0.276	0.551	18	DHT 78	DHT 78	DHT 78	DHT 78	DHT 78	-	-	-	
0.01	103	1.457	0.276	0.551	18	DHT 78	DHT 78	DHT 78	DHT 78	-	-	-	-	
0.015	153	1.457	0.276	0.551	18	DHT 78	DHT 78	DHT 78	-	-	-	-	-	
0.022	223	1.457	0.276	0.551	18	DHT 78	DHT 78	-	-	-	-	-	-	
0.033	333	1.457	0.276	0.551	18	DHT 78	-	-	-	-	-	-	-	
0.00068	681	1.457	0.276	0.709	18	DHT 78	DHT 78	DHT 78	DHT 78	DHT 78	DHT 78	DHT 78	DHT 78	
0.0015	152	1.457	0.276	0.709	18	DHT 78	DHT 78	DHT 78	DHT 78	DHT 78	DHT 78	DHT 78	-	
0.0033	332	1.457	0.276	0.709	18	DHT 78	DHT 78	DHT 78	DHT 78	DHT 78	DHT 78	-	-	
0.0068	682	1.457	0.276	0.709	18	DHT 78	DHT 78	DHT 78	DHT 78	DHT 78	-	-	-	
0.015	153	1.457	0.276	0.709	18	DHT 78	DHT 78	DHT 78	DHT 78	-	-	-	-	
0.022	223	1.457	0.276	0.709	18	DHT 78	DHT 78	DHT 78	-	-	-	-	-	
0.033	333	1.457	0.276	0.709	18	DHT 78	DHT 78	-	-	-	-	-	-	
0.047	473	1.457	0.276	0.709	18	DHT 78	-	-	-	-	-	-	-	
0.001	102	1.475	0.315	0.748	18	DHT 78	DHT 78	DHT 78	DHT 78	DHT 78	DHT 78	DHT 78	DHT 78	
0.0022	222	1.457	0.315	0.748	18	DHT 78	DHT 78	DHT 78	DHT 78	DHT 78	DHT 78	DHT 78	-	
0.0047	472	1.457	0.315	0.748	18	DHT 78	DHT 78	DHT 78	DHT 78	DHT 78	DHT 78	DHT 78	-	
0.01	103	1.457	0.315	0.748	18	DHT 78	DHT 78	DHT 78	DHT 78	DHT 78	-	-	-	
0.022	223	1.457	0.315	0.748	18	DHT 78	DHT 78	DHT 78	DHT 78	-	-	-	-	
0.033	333	1.457	0.315	0.748	18	DHT 78	DHT 78	DHT 78	-	-	-	-	-	
0.047	473	1.457	0.315	0.748	18	DHT 78	DHT 78	-	-	-	-	-	-	
0.068	683	1.457	0.315	0.748	18	DHT 78	-	-	-	-	-	-	-	
0.0015	152	1.457	0.315	0.984	18	DHT 78	DHT 78	DHT 78	DHT 78	DHT 78	DHT 78	DHT 78	DHT 78	
0.0033	332	1.457	0.315	0.984	18	DHT 78	DHT 78	DHT 78	DHT 78	DHT 78	DHT 78	DHT 78	-	
0.0068	682	1.457	0.315	0.984	18	DHT 78	DHT 78	DHT 78	DHT 78	DHT 78	DHT 78	-	-	
0.015	153	1.457	0.315	0.984	18	DHT 78	DHT 78	DHT 78	DHT 78	DHT 78	-	-	-	
0.033	333	1.457	0.315	0.984	18	DHT 78	DHT 78	DHT 78	DHT 78	-	-	-	-	
0.047	473	1.457	0.315	0.984	18	DHT 78	DHT 78	DHT 78	-	-	-	-	-	
0.068	683	1.457	0.315	0.984	18	DHT 78	DHT 78	-	-	-	-	-	-	
0.1	104	1.457	0.315	0.984	18	DHT 78	-	-	-	-	-	-	-	
0.0022	222	1.457	0.394	1.063	18	DHT 78	DHT 78	DHT 78	DHT 78	DHT 78	DHT 78	DHT 78	DHT 78	
0.0047	472	1.457	0.394	1.063	18	DHT 78	DHT 78	DHT 78	DHT 78	DHT 78	DHT 78	DHT 78	-	
0.01	103	1.457	0.394	1.063	18	DHT 78	DHT 78	DHT 78	DHT 78	DHT 78	DHT 78	-	-	
0.022	223	1.457	0.394	1.063	18	DHT 78	DHT 78	DHT 78	DHT 78	DHT 78	-	-	-	
0.047	473	1.457	0.394	1.063	18	DHT 78	DHT 78	DHT 78	DHT 78	-	-	-	-	
0.068	683	1.457	0.394	1.063	18	DHT 78	DHT 78	DHT 78	-	-	-	-	-	
0.1	104	1.457	0.394	1.063	18	DHT 78	DHT 78	-	-	-	-	-	-	
0.15	154	1.457	0.394	1.063	18	DHT 78	-	-	-	-	-	-	-	
0.0033	332	1.457	0.355	1.575	18	DHT 78	DHT 78	DHT 78	DHT 78	DHT 78	DHT 78	DHT 78	DHT 78	
0.0068	682	1.457	0.355	1.575	18	DHT 78	DHT 78	DHT 78	DHT 78	DHT 78	DHT 78	DHT 78	-	
0.015	153	1.457	0.355	1.575	18	DHT 78	DHT 78	DHT 78	DHT 78	DHT 78	DHT 78	-	-	
0.033	333	1.457	0.355	1.575	18	DHT 78	DHT 78	DHT 78	DHT 78	DHT 78	-	-	-	
0.068	683	1.457	0.355	1.575	18	DHT 78	DHT 78	DHT 78	DHT 78	-	-	-	-	
0.1	104	1.457	0.355	1.575	18	DHT 78	DHT 78	DHT 78	-	-	-	-	-	
0.15	154	1.457	0.355	1.575	18	DHT 78	DHT 78	-	-	-	-	-	-	
0.22	224	1.457	0.355	1.575	18	DHT 78	-	-	-	-	-	-	-	

MICA HIGH VOLTAGE CAPACITORS

STANDARD RATINGS

Capacitance		Dimensions (in inches)				TYPE DHT 78								
µF	Code	Max. "L"	Max. "E"	Max. "H"	"W" Gauge	630 V	1,000 V	1,500 V	2,500 V	3,500 V	5,000 V	7,500 V	10,000 V	
0.0047	472	1.457	0.512	1.693	18	DHT 78	DHT 78	DHT 78	DHT 78	DHT 78	DHT 78	DHT 78	DHT 78	
0.01	103	1.457	0.512	1.693	18	DHT 78	DHT 78	DHT 78	DHT 78	DHT 78	DHT 78	DHT 78	-	
0.022	223	1.457	0.512	1.693	18	DHT 78	DHT 78	DHT 78	DHT 78	DHT 78	DHT 78	-	-	
0.047	473	1.457	0.512	1.693	18	DHT 78	DHT 78	DHT 78	DHT 78	DHT 78	-	-	-	
0.1	104	1.457	0.512	1.693	18	DHT 78	DHT 78	DHT 78	DHT 78	-	-	-	-	
0.15	154	1.457	0.512	1.693	18	DHT 78	DHT 78	DHT 78	-	-	-	-	-	
0.22	224	1.457	0.512	1.693	18	DHT 78	DHT 78	-	-	-	-	-	-	
0.33	334	1.457	0.512	1.693	18	DHT 78	-	-	-	-	-	-	-	
0.0068	682	2.48	0.315	1.536	18	DHT 78	DHT 78	DHT 78	DHT 78	DHT 78	DHT 78	DHT 78	DHT 78	
0.015	153	2.48	0.315	1.536	18	DHT 78	DHT 78	DHT 78	DHT 78	DHT 78	DHT 78	DHT 78	-	
0.033	333	2.48	0.315	1.536	18	DHT 78	DHT 78	DHT 78	DHT 78	DHT 78	DHT 78	-	-	
0.068	683	2.48	0.315	1.536	18	DHT 78	DHT 78	DHT 78	DHT 78	DHT 78	-	-	-	
0.15	154	2.48	0.315	1.536	18	DHT 78	DHT 78	DHT 78	DHT 78	-	-	-	-	
0.22	224	2.48	0.315	1.536	18	DHT 78	DHT 78	DHT 78	-	-	-	-	-	
0.33	334	2.48	0.315	1.536	18	DHT 78	DHT 78	-	-	-	-	-	-	
0.47	474	2.48	0.315	1.536	18	DHT 78	-	-	-	-	-	-	-	
0.01	103	2.48	0.355	1.969	18	DHT 78	DHT 78	DHT 78	DHT 78	DHT 78	DHT 78	DHT 78	DHT 78	
0.022	223	2.48	0.355	1.969	18	DHT 78	DHT 78	DHT 78	DHT 78	DHT 78	DHT 78	DHT 78	-	
0.047	473	2.48	0.355	1.969	18	DHT 78	DHT 78	DHT 78	DHT 78	DHT 78	DHT 78	-	-	
0.1	104	2.48	0.355	1.969	18	DHT 78	DHT 78	DHT 78	DHT 78	DHT 78	-	-	-	
0.22	224	2.48	0.355	1.969	18	DHT 78	DHT 78	DHT 78	DHT 78	-	-	-	-	
0.33	334	2.48	0.355	1.969	18	DHT 78	DHT 78	DHT 78	-	-	-	-	-	
0.47	474	2.48	0.355	1.969	18	DHT 78	DHT 78	-	-	-	-	-	-	
0.68	684	2.48	0.355	1.969	18	DHT 78	-	-	-	-	-	-	-	
0.015	153	2.48	4.33	2.047	18	DHT 78	DHT 78	DHT 78	DHT 78	DHT 78	DHT 78	DHT 78	DHT 78	
0.033	333	2.48	4.33	2.047	18	DHT 78	DHT 78	DHT 78	DHT 78	DHT 78	DHT 78	DHT 78	-	
0.068	683	2.48	0.433	2.047	18	DHT 78	DHT 78	DHT 78	DHT 78	DHT 78	DHT 78	-	-	
0.15	154	2.48	0.433	2.047	18	DHT 78	DHT 78	DHT 78	DHT 78	DHT 78	-	-	-	
0.33	334	2.48	0.433	2.047	18	DHT 78	DHT 78	DHT 78	DHT 78	-	-	-	-	
0.47	474	2.48	0.433	2.047	18	DHT 78	DHT 78	DHT 78	-	-	-	-	-	
0.68	684	2.48	0.433	2.047	18	DHT 78	DHT 78	-	-	-	-	-	-	
1	105	2.48	0.433	2.047	18	DHT 78	-	-	-	-	-	-	-	
0.022	223	2.48	0.591	2.166	18	DHT 78	DHT 78	DHT 78	DHT 78	DHT 78	DHT 78	DHT 78	DHT 78	
0.047	473	2.48	0.591	2.166	18	DHT 78	DHT 78	DHT 78	DHT 78	DHT 78	DHT 78	DHT 78	-	
0.1	104	2.48	0.591	2.166	18	DHT 78	DHT 78	DHT 78	DHT 78	DHT 78	DHT 78	-	-	
0.22	224	2.48	0.591	2.166	18	DHT 78	DHT 78	DHT 78	DHT 78	DHT 78	-	-	-	
0.47	474	2.48	0.591	2.166	18	DHT 78	DHT 78	DHT 78	DHT 78	-	-	-	-	
0.68	684	2.48	0.591	2.166	18	DHT 78	DHT 78	DHT 78	-	-	-	-	-	
1	105	2.48	0.591	2.166	18	DHT 78	DHT 78	-	-	-	-	-	-	
1.5	155	2.48	0.591	2.166	18	DHT 78	-	-	-	-	-	-	-	
0.033	333	3.189	0.512	2.087	16	-	DHT 78	DHT 78	DHT 78	DHT 78	DHT 78	DHT 78	DHT 78	
0.068	683	3.189	0.512	2.087	16	-	DHT 78	DHT 78	DHT 78	DHT 78	DHT 78	DHT 78	-	
0.15	154	3.189	0.512	2.087	16	-	DHT 78	DHT 78	DHT 78	DHT 78	DHT 78	-	-	
0.33	334	3.189	0.512	2.087	16	-	DHT 78	DHT 78	DHT 78	DHT 78	-	-	-	
0.68	684	3.189	0.512	2.087	16	-	DHT 78	DHT 78	DHT 78	-	-	-	-	
1	105	3.189	0.512	2.087	16	-	DHT 78	DHT 78	-	-	-	-	-	
1.5	155	3.189	0.512	2.087	16	-	DHT 78	-	-	-	-	-	-	
0.047	473	3.189	0.788	1.969	16	-	-	DHT 78	DHT 78	DHT 78	DHT 78	DHT 78	DHT 78	
0.1	104	3.189	0.788	1.969	16	-	-	DHT 78	DHT 78	DHT 78	DHT 78	DHT 78	-	
0.22	224	3.189	0.788	1.969	16	-	-	DHT 78	DHT 78	DHT 78	DHT 78	-	-	
0.47	474	3.189	0.788	1.969	16	-	-	DHT 78	DHT 78	DHT 78	-	-	-	
1	105	3.189	0.788	1.969	16	-	-	DHT 78	DHT 78	-	-	-	-	
1.5	155	3.189	0.788	1.969	16	-	-	DHT 78	-	-	-	-	-	

MICA HIGH VOLTAGE CAPACITORS

TYPE DHT 78 /
DHT 78P⁽¹⁾

STANDARD RATINGS

Capacitance		Dimensions (in inches)				TYPE DHT 78P ⁽¹⁾							
μF	Code	Max. "L"	Max. "E"	Max. "H"	"W" Gauge	630 V	1,000 V	1,500 V	2,500 V	3,500 V	5,000 V	7,500 V	10,000 V
0.00033	331	1.418	0.197	0.433	18	DHT 78P ⁽¹⁾	DHT 78P ⁽¹⁾	DHT 78P ⁽¹⁾	DHT 78P ⁽¹⁾	DHT 78P ⁽¹⁾	DHT 78P ⁽¹⁾	DHT 78P ⁽¹⁾	DHT 78P ⁽¹⁾
0.00068	681	1.418	0.197	0.433	18	DHT 78P ⁽¹⁾	DHT 78P ⁽¹⁾	DHT 78P ⁽¹⁾	DHT 78P ⁽¹⁾	DHT 78P ⁽¹⁾	DHT 78P ⁽¹⁾	DHT 78P ⁽¹⁾	-
0.0015	152	1.418	0.197	0.433	18	DHT 78P ⁽¹⁾	DHT 78P ⁽¹⁾	DHT 78P ⁽¹⁾	DHT 78P ⁽¹⁾	DHT 78P ⁽¹⁾	DHT 78P ⁽¹⁾	DHT 78P ⁽¹⁾	-
0.0033	332	1.418	0.197	0.433	18	DHT 78P ⁽¹⁾	DHT 78P ⁽¹⁾	DHT 78P ⁽¹⁾	DHT 78P ⁽¹⁾	DHT 78P ⁽¹⁾	-	-	-
0.0068	682	1.418	0.197	0.433	18	DHT 78P ⁽¹⁾	DHT 78P ⁽¹⁾	DHT 78P ⁽¹⁾	DHT 78P ⁽¹⁾	-	-	-	-
0.01	103	1.418	0.197	0.433	18	DHT 78P ⁽¹⁾	DHT 78P ⁽¹⁾	DHT 78P ⁽¹⁾	-	-	-	-	-
0.015	153	1.418	0.197	0.433	18	DHT 78P ⁽¹⁾	DHT 78P ⁽¹⁾	-	-	-	-	-	-
0.022	223	1.418	0.197	0.433	18	DHT 78P ⁽¹⁾	-	-	-	-	-	-	-
0.00047	471	1.418	0.276	0.512	18	DHT 78P ⁽¹⁾	DHT 78P ⁽¹⁾	DHT 78P ⁽¹⁾	DHT 78P ⁽¹⁾	DHT 78P ⁽¹⁾	DHT 78P ⁽¹⁾	DHT 78P ⁽¹⁾	DHT 78P ⁽¹⁾
0.001	102	1.418	0.276	0.512	18	DHT 78P ⁽¹⁾	DHT 78P ⁽¹⁾	DHT 78P ⁽¹⁾	DHT 78P ⁽¹⁾	DHT 78P ⁽¹⁾	DHT 78P ⁽¹⁾	DHT 78P ⁽¹⁾	-
0.022	222	1.418	0.276	0.512	18	DHT 78P ⁽¹⁾	DHT 78P ⁽¹⁾	DHT 78P ⁽¹⁾	DHT 78P ⁽¹⁾	DHT 78P ⁽¹⁾	DHT 78P ⁽¹⁾	-	-
0.0047	472	1.418	0.276	0.512	18	DHT 78P ⁽¹⁾	DHT 78P ⁽¹⁾	DHT 78P ⁽¹⁾	DHT 78P ⁽¹⁾	DHT 78P ⁽¹⁾	-	-	-
0.01	103	1.418	0.276	0.512	18	DHT 78P ⁽¹⁾	DHT 78P ⁽¹⁾	DHT 78P ⁽¹⁾	DHT 78P ⁽¹⁾	-	-	-	-
0.015	153	1.418	0.276	0.512	18	DHT 78P ⁽¹⁾	DHT 78P ⁽¹⁾	DHT 78P ⁽¹⁾	-	-	-	-	-
0.022	223	1.418	0.276	0.512	18	DHT 78P ⁽¹⁾	DHT 78P ⁽¹⁾	-	-	-	-	-	-
0.033	333	1.418	0.276	0.512	18	DHT 78P ⁽¹⁾	-	-	-	-	-	-	-
0.00068	681	1.418	0.276	0.67	18	DHT 78P ⁽¹⁾	DHT 78P ⁽¹⁾	DHT 78P ⁽¹⁾	DHT 78P ⁽¹⁾	DHT 78P ⁽¹⁾	DHT 78P ⁽¹⁾	DHT 78P ⁽¹⁾	DHT 78P ⁽¹⁾
0.0015	152	1.418	0.276	0.67	18	DHT 78P ⁽¹⁾	DHT 78P ⁽¹⁾	DHT 78P ⁽¹⁾	DHT 78P ⁽¹⁾	DHT 78P ⁽¹⁾	DHT 78P ⁽¹⁾	DHT 78P ⁽¹⁾	-
0.0033	332	1.418	0.276	0.67	18	DHT 78P ⁽¹⁾	DHT 78P ⁽¹⁾	DHT 78P ⁽¹⁾	DHT 78P ⁽¹⁾	DHT 78P ⁽¹⁾	DHT 78P ⁽¹⁾	-	-
0.0068	682	1.418	0.276	0.67	18	DHT 78P ⁽¹⁾	DHT 78P ⁽¹⁾	DHT 78P ⁽¹⁾	DHT 78P ⁽¹⁾	DHT 78P ⁽¹⁾	DHT 78P ⁽¹⁾	-	-
0.015	153	1.418	0.276	0.67	18	DHT 78P ⁽¹⁾	DHT 78P ⁽¹⁾	DHT 78P ⁽¹⁾	DHT 78P ⁽¹⁾	-	-	-	-
0.022	223	1.418	0.276	0.67	18	DHT 78P ⁽¹⁾	DHT 78P ⁽¹⁾	DHT 78P ⁽¹⁾	-	-	-	-	-
0.033	333	1.418	0.276	0.67	18	DHT 78P ⁽¹⁾	DHT 78P ⁽¹⁾	-	-	-	-	-	-
0.047	473	1.418	0.276	0.67	18	DHT 78P ⁽¹⁾	-	-	-	-	-	-	-
0.001	102	1.418	0.315	0.709	18	DHT 78P ⁽¹⁾	DHT 78P ⁽¹⁾	DHT 78P ⁽¹⁾	DHT 78P ⁽¹⁾	DHT 78P ⁽¹⁾	DHT 78P ⁽¹⁾	DHT 78P ⁽¹⁾	DHT 78P ⁽¹⁾
0.0022	222	1.418	0.315	0.709	18	DHT 78P ⁽¹⁾	DHT 78P ⁽¹⁾	DHT 78P ⁽¹⁾	DHT 78P ⁽¹⁾	DHT 78P ⁽¹⁾	DHT 78P ⁽¹⁾	DHT 78P ⁽¹⁾	-
0.0047	472	1.418	0.315	0.709	18	DHT 78P ⁽¹⁾	DHT 78P ⁽¹⁾	DHT 78P ⁽¹⁾	DHT 78P ⁽¹⁾	DHT 78P ⁽¹⁾	DHT 78P ⁽¹⁾	-	-
0.01	103	1.418	0.315	0.709	18	DHT 78P ⁽¹⁾	DHT 78P ⁽¹⁾	DHT 78P ⁽¹⁾	DHT 78P ⁽¹⁾	DHT 78P ⁽¹⁾	-	-	-
0.022	223	1.418	0.315	0.709	18	DHT 78P ⁽¹⁾	DHT 78P ⁽¹⁾	DHT 78P ⁽¹⁾	DHT 78P ⁽¹⁾	-	-	-	-
0.033	333	1.418	0.315	0.709	18	DHT 78P ⁽¹⁾	DHT 78P ⁽¹⁾	DHT 78P ⁽¹⁾	-	-	-	-	-
0.047	473	1.418	0.315	0.709	18	DHT 78P ⁽¹⁾	DHT 78P ⁽¹⁾	-	-	-	-	-	-
0.068	683	1.418	0.315	0.709	18	DHT 78P ⁽¹⁾	-	-	-	-	-	-	-
0.0015	152	1.418	0.315	0.945	18	DHT 78P ⁽¹⁾	DHT 78P ⁽¹⁾	DHT 78P ⁽¹⁾	DHT 78P ⁽¹⁾	DHT 78P ⁽¹⁾	DHT 78P ⁽¹⁾	DHT 78P ⁽¹⁾	DHT 78P ⁽¹⁾
0.0033	332	1.418	0.315	0.945	18	DHT 78P ⁽¹⁾	DHT 78P ⁽¹⁾	DHT 78P ⁽¹⁾	DHT 78P ⁽¹⁾	DHT 78P ⁽¹⁾	DHT 78P ⁽¹⁾	DHT 78P ⁽¹⁾	-
0.0068	682	1.418	0.315	0.945	18	DHT 78P ⁽¹⁾	DHT 78P ⁽¹⁾	DHT 78P ⁽¹⁾	DHT 78P ⁽¹⁾	DHT 78P ⁽¹⁾	DHT 78P ⁽¹⁾	-	-
0.015	153	1.418	0.315	0.945	18	DHT 78P ⁽¹⁾	DHT 78P ⁽¹⁾	DHT 78P ⁽¹⁾	DHT 78P ⁽¹⁾	DHT 78P ⁽¹⁾	-	-	-
0.033	333	1.418	0.315	0.945	18	DHT 78P ⁽¹⁾	DHT 78P ⁽¹⁾	DHT 78P ⁽¹⁾	DHT 78P ⁽¹⁾	-	-	-	-
0.047	473	1.418	0.315	0.945	18	DHT 78P ⁽¹⁾	DHT 78P ⁽¹⁾	-	-	-	-	-	-
0.068	683	1.418	0.315	0.945	18	DHT 78P ⁽¹⁾	DHT 78P ⁽¹⁾	-	-	-	-	-	-
0.1	104	1.418	0.315	0.945	18	DHT 78P ⁽¹⁾	-	-	-	-	-	-	-
0.0022	222	1.418	0.394	1.024	18	DHT 78P ⁽¹⁾	DHT 78P ⁽¹⁾	DHT 78P ⁽¹⁾	DHT 78P ⁽¹⁾	DHT 78P ⁽¹⁾	DHT 78P ⁽¹⁾	DHT 78P ⁽¹⁾	DHT 78P ⁽¹⁾
0.0047	472	1.418	0.394	1.024	18	DHT 78P ⁽¹⁾	DHT 78P ⁽¹⁾	DHT 78P ⁽¹⁾	DHT 78P ⁽¹⁾	DHT 78P ⁽¹⁾	DHT 78P ⁽¹⁾	DHT 78P ⁽¹⁾	-
0.01	103	1.418	0.394	1.024	18	DHT 78P ⁽¹⁾	DHT 78P ⁽¹⁾	DHT 78P ⁽¹⁾	DHT 78P ⁽¹⁾	DHT 78P ⁽¹⁾	DHT 78P ⁽¹⁾	DHT 78P ⁽¹⁾	-
0.022	223	1.418	0.394	1.024	18	DHT 78P ⁽¹⁾	DHT 78P ⁽¹⁾	DHT 78P ⁽¹⁾	DHT 78P ⁽¹⁾	DHT 78P ⁽¹⁾	-	-	-
0.047	473	1.418	0.394	1.024	18	DHT 78P ⁽¹⁾	DHT 78P ⁽¹⁾	DHT 78P ⁽¹⁾	DHT 78P ⁽¹⁾	-	-	-	-
0.068	683	1.418	0.394	1.024	18	DHT 78P ⁽¹⁾	DHT 78P ⁽¹⁾	DHT 78P ⁽¹⁾	-	-	-	-	-
0.1	104	1.418	0.394	1.024	18	DHT 78P ⁽¹⁾	DHT 78P ⁽¹⁾	-	-	-	-	-	-
0.15	154	1.418	0.394	1.024	18	DHT 78P ⁽¹⁾	-	-	-	-	-	-	-
0.0033	332	1.418	0.355	1.536	18	DHT 78P ⁽¹⁾	DHT 78P ⁽¹⁾	DHT 78P ⁽¹⁾	DHT 78P ⁽¹⁾	DHT 78P ⁽¹⁾	DHT 78P ⁽¹⁾	DHT 78P ⁽¹⁾	DHT 78P ⁽¹⁾
0.0068	682	1.418	0.355	1.536	18	DHT 78P ⁽¹⁾	DHT 78P ⁽¹⁾	DHT 78P ⁽¹⁾	DHT 78P ⁽¹⁾	DHT 78P ⁽¹⁾	DHT 78P ⁽¹⁾	DHT 78P ⁽¹⁾	-
0.015	153	1.418	0.355	1.536	18	DHT 78P ⁽¹⁾	DHT 78P ⁽¹⁾	DHT 78P ⁽¹⁾	DHT 78P ⁽¹⁾	DHT 78P ⁽¹⁾	DHT 78P ⁽¹⁾	-	-
0.033	333	1.418	0.355	1.536	18	DHT 78P ⁽¹⁾	DHT 78P ⁽¹⁾	DHT 78P ⁽¹⁾	DHT 78P ⁽¹⁾	DHT 78P ⁽¹⁾	-	-	-
0.068	683	1.418	0.355	1.536	18	DHT 78P ⁽¹⁾	DHT 78P ⁽¹⁾	DHT 78P ⁽¹⁾	DHT 78P ⁽¹⁾	-	-	-	-
0.1	104	1.418	0.355	1.536	18	DHT 78P ⁽¹⁾	DHT 78P ⁽¹⁾	DHT 78P ⁽¹⁾	-	-	-	-	-
0.15	154	1.418	0.355	1.536	18	DHT 78P ⁽¹⁾	DHT 78P ⁽¹⁾	-	-	-	-	-	-
0.22	224	1.418	0.355	1.536	18	DHT 78P ⁽¹⁾	-	-	-	-	-	-	-

MICA HIGH VOLTAGE CAPACITORS

STANDARD RATINGS

Capacitance		Dimensions (in inches)				TYPE DHT 78P ⁽¹⁾								
µF	Code	Max. "L"	Max. "E"	Max. "H"	"W" Gauge	630 V	1,000 V	1,500 V	2,500 V	3,500 V	5,000 V	7,500 V	10,000 V	
0.0047	472	1.418	0.473	1.654	18	DHT 78P ⁽¹⁾	DHT 78P ⁽¹⁾	DHT 78P ⁽¹⁾	DHT 78P ⁽¹⁾	DHT 78P ⁽¹⁾	DHT 78P ⁽¹⁾	DHT 78P ⁽¹⁾	DHT 78P ⁽¹⁾	
0.01	103	1.418	0.473	1.654	18	DHT 78P ⁽¹⁾	DHT 78P ⁽¹⁾	DHT 78P ⁽¹⁾	DHT 78P ⁽¹⁾	DHT 78P ⁽¹⁾	DHT 78P ⁽¹⁾	DHT 78P ⁽¹⁾	-	
0.022	223	1.418	0.473	1.654	18	DHT 78P ⁽¹⁾	DHT 78P ⁽¹⁾	DHT 78P ⁽¹⁾	DHT 78P ⁽¹⁾	DHT 78P ⁽¹⁾	DHT 78P ⁽¹⁾	DHT 78P ⁽¹⁾	-	
0.047	473	1.418	0.473	1.654	18	DHT 78P ⁽¹⁾	DHT 78P ⁽¹⁾	DHT 78P ⁽¹⁾	DHT 78P ⁽¹⁾	DHT 78P ⁽¹⁾	-	-	-	
0.1	104	1.418	0.473	1.654	18	DHT 78P ⁽¹⁾	DHT 78P ⁽¹⁾	DHT 78P ⁽¹⁾	DHT 78P ⁽¹⁾	-	-	-	-	
0.15	154	1.418	0.473	1.654	18	DHT 78P ⁽¹⁾	DHT 78P ⁽¹⁾	DHT 78P ⁽¹⁾	-	-	-	-	-	
0.22	224	1.418	0.473	1.654	18	DHT 78P ⁽¹⁾	DHT 78P ⁽¹⁾	-	-	-	-	-	-	
0.33	334	1.418	0.473	1.654	18	DHT 78P ⁽¹⁾	-	-	-	-	-	-	-	
0.0068	682	2.441	0.315	1.496	18	DHT 78P ⁽¹⁾	DHT 78P ⁽¹⁾	DHT 78P ⁽¹⁾	DHT 78P ⁽¹⁾	DHT 78P ⁽¹⁾	DHT 78P ⁽¹⁾	DHT 78P ⁽¹⁾	DHT 78P ⁽¹⁾	
0.015	153	2.441	0.315	1.496	18	DHT 78P ⁽¹⁾	DHT 78P ⁽¹⁾	DHT 78P ⁽¹⁾	DHT 78P ⁽¹⁾	DHT 78P ⁽¹⁾	DHT 78P ⁽¹⁾	DHT 78P ⁽¹⁾	-	
0.033	333	2.441	0.315	1.496	18	DHT 78P ⁽¹⁾	DHT 78P ⁽¹⁾	DHT 78P ⁽¹⁾	DHT 78P ⁽¹⁾	DHT 78P ⁽¹⁾	DHT 78P ⁽¹⁾	-	-	
0.068	683	2.441	0.315	1.496	18	DHT 78P ⁽¹⁾	DHT 78P ⁽¹⁾	DHT 78P ⁽¹⁾	DHT 78P ⁽¹⁾	DHT 78P ⁽¹⁾	-	-	-	
0.15	154	2.441	0.315	1.496	18	DHT 78P ⁽¹⁾	DHT 78P ⁽¹⁾	DHT 78P ⁽¹⁾	DHT 78P ⁽¹⁾	-	-	-	-	
0.22	224	2.441	0.315	1.496	18	DHT 78P ⁽¹⁾	DHT 78P ⁽¹⁾	DHT 78P ⁽¹⁾	-	-	-	-	-	
0.33	334	2.441	0.315	1.496	18	DHT 78P ⁽¹⁾	DHT 78P ⁽¹⁾	-	-	-	-	-	-	
0.47	474	2.441	0.315	1.496	18	DHT 78P ⁽¹⁾	-	-	-	-	-	-	-	
0.01	103	2.441	0.355	1.929	18	DHT 78P ⁽¹⁾	DHT 78P ⁽¹⁾	DHT 78P ⁽¹⁾	DHT 78P ⁽¹⁾	DHT 78P ⁽¹⁾	DHT 78P ⁽¹⁾	DHT 78P ⁽¹⁾	DHT 78P ⁽¹⁾	
0.022	223	2.441	0.355	1.929	18	DHT 78P ⁽¹⁾	DHT 78P ⁽¹⁾	DHT 78P ⁽¹⁾	DHT 78P ⁽¹⁾	DHT 78P ⁽¹⁾	DHT 78P ⁽¹⁾	DHT 78P ⁽¹⁾	-	
0.047	473	2.441	0.355	1.929	18	DHT 78P ⁽¹⁾	DHT 78P ⁽¹⁾	DHT 78P ⁽¹⁾	DHT 78P ⁽¹⁾	DHT 78P ⁽¹⁾	DHT 78P ⁽¹⁾	-	-	
0.1	104	2.441	0.355	1.929	18	DHT 78P ⁽¹⁾	DHT 78P ⁽¹⁾	DHT 78P ⁽¹⁾	DHT 78P ⁽¹⁾	DHT 78P ⁽¹⁾	DHT 78P ⁽¹⁾	-	-	
0.22	224	2.441	0.355	1.929	18	DHT 78P ⁽¹⁾	DHT 78P ⁽¹⁾	DHT 78P ⁽¹⁾	DHT 78P ⁽¹⁾	-	-	-	-	
0.33	334	2.441	0.355	1.929	18	DHT 78P ⁽¹⁾	DHT 78P ⁽¹⁾	DHT 78P ⁽¹⁾	-	-	-	-	-	
0.47	474	2.441	0.355	1.929	18	DHT 78P ⁽¹⁾	DHT 78P ⁽¹⁾	-	-	-	-	-	-	
0.68	684	2.441	0.355	1.929	18	DHT 78P ⁽¹⁾	-	-	-	-	-	-	-	
0.015	153	2.441	0.433	2.008	18	DHT 78P ⁽¹⁾	DHT 78P ⁽¹⁾	DHT 78P ⁽¹⁾	DHT 78P ⁽¹⁾	DHT 78P ⁽¹⁾	DHT 78P ⁽¹⁾	DHT 78P ⁽¹⁾	DHT 78P ⁽¹⁾	
0.033	333	2.441	0.433	2.008	18	DHT 78P ⁽¹⁾	DHT 78P ⁽¹⁾	DHT 78P ⁽¹⁾	DHT 78P ⁽¹⁾	DHT 78P ⁽¹⁾	DHT 78P ⁽¹⁾	DHT 78P ⁽¹⁾	-	
0.068	683	2.441	0.433	2.008	18	DHT 78P ⁽¹⁾	DHT 78P ⁽¹⁾	DHT 78P ⁽¹⁾	DHT 78P ⁽¹⁾	DHT 78P ⁽¹⁾	DHT 78P ⁽¹⁾	-	-	
0.15	154	2.441	0.433	2.008	18	DHT 78P ⁽¹⁾	DHT 78P ⁽¹⁾	DHT 78P ⁽¹⁾	DHT 78P ⁽¹⁾	DHT 78P ⁽¹⁾	-	-	-	
0.33	334	2.441	0.433	2.008	18	DHT 78P ⁽¹⁾	DHT 78P ⁽¹⁾	DHT 78P ⁽¹⁾	DHT 78P ⁽¹⁾	-	-	-	-	
0.47	474	2.441	0.433	2.008	18	DHT 78P ⁽¹⁾	DHT 78P ⁽¹⁾	DHT 78P ⁽¹⁾	-	-	-	-	-	
0.68	684	2.441	0.433	2.008	18	DHT 78P ⁽¹⁾	DHT 78P ⁽¹⁾	-	-	-	-	-	-	
1	105	2.441	0.433	2.008	18	DHT 78P ⁽¹⁾	-	-	-	-	-	-	-	
0.022	223	2.441	0.551	2.126	18	DHT 78P ⁽¹⁾	DHT 78P ⁽¹⁾	DHT 78P ⁽¹⁾	DHT 78P ⁽¹⁾	DHT 78P ⁽¹⁾	DHT 78P ⁽¹⁾	DHT 78P ⁽¹⁾	DHT 78P ⁽¹⁾	
0.047	473	2.441	0.551	2.126	18	DHT 78P ⁽¹⁾	DHT 78P ⁽¹⁾	DHT 78P ⁽¹⁾	DHT 78P ⁽¹⁾	DHT 78P ⁽¹⁾	DHT 78P ⁽¹⁾	DHT 78P ⁽¹⁾	-	
0.1	104	2.441	0.551	2.126	18	DHT 78P ⁽¹⁾	DHT 78P ⁽¹⁾	DHT 78P ⁽¹⁾	DHT 78P ⁽¹⁾	DHT 78P ⁽¹⁾	DHT 78P ⁽¹⁾	-	-	
0.22	224	2.441	0.551	2.126	18	DHT 78P ⁽¹⁾	DHT 78P ⁽¹⁾	DHT 78P ⁽¹⁾	DHT 78P ⁽¹⁾	DHT 78P ⁽¹⁾	-	-	-	
0.47	474	2.441	0.551	2.126	18	DHT 78P ⁽¹⁾	DHT 78P ⁽¹⁾	DHT 78P ⁽¹⁾	DHT 78P ⁽¹⁾	-	-	-	-	
0.68	684	2.441	0.551	2.126	18	DHT 78P ⁽¹⁾	DHT 78P ⁽¹⁾	DHT 78P ⁽¹⁾	-	-	-	-	-	
1	105	2.441	0.551	2.126	18	DHT 78P ⁽¹⁾	DHT 78P ⁽¹⁾	-	-	-	-	-	-	
1.5	155	2.441	0.551	2.126	18	DHT 78P ⁽¹⁾	-	-	-	-	-	-	-	
0.033	333	3.15	0.473	2.047	16	-	DHT 78P ⁽¹⁾	DHT 78P ⁽¹⁾	DHT 78P ⁽¹⁾	DHT 78P ⁽¹⁾	DHT 78P ⁽¹⁾	DHT 78P ⁽¹⁾	DHT 78P ⁽¹⁾	
0.068	683	3.15	0.473	2.047	16	-	DHT 78P ⁽¹⁾	DHT 78P ⁽¹⁾	DHT 78P ⁽¹⁾	DHT 78P ⁽¹⁾	DHT 78P ⁽¹⁾	DHT 78P ⁽¹⁾	-	
0.15	154	3.15	0.473	2.047	16	-	DHT 78P ⁽¹⁾	DHT 78P ⁽¹⁾	DHT 78P ⁽¹⁾	DHT 78P ⁽¹⁾	DHT 78P ⁽¹⁾	DHT 78P ⁽¹⁾	-	
0.33	334	3.15	0.473	2.047	16	-	DHT 78P ⁽¹⁾	DHT 78P ⁽¹⁾	DHT 78P ⁽¹⁾	DHT 78P ⁽¹⁾	-	-	-	
0.68	684	3.15	0.473	2.047	16	-	DHT 78P ⁽¹⁾	DHT 78P ⁽¹⁾	DHT 78P ⁽¹⁾	-	-	-	-	
1	105	3.15	0.473	2.047	16	-	DHT 78P ⁽¹⁾	DHT 78P ⁽¹⁾	-	-	-	-	-	
1.5	155	3.15	0.473	2.047	16	-	DHT 78P ⁽¹⁾	-	-	-	-	-	-	
0.047	473	3.15	0.748	1.929	16	-	-	DHT 78P ⁽¹⁾	DHT 78P ⁽¹⁾	DHT 78P ⁽¹⁾	DHT 78P ⁽¹⁾	DHT 78P ⁽¹⁾	DHT 78P ⁽¹⁾	
0.1	104	3.15	0.748	1.929	16	-	-	DHT 78P ⁽¹⁾	DHT 78P ⁽¹⁾	DHT 78P ⁽¹⁾	DHT 78P ⁽¹⁾	DHT 78P ⁽¹⁾	-	
0.22	224	3.15	0.748	1.929	16	-	-	DHT 78P ⁽¹⁾	DHT 78P ⁽¹⁾	DHT 78P ⁽¹⁾	DHT 78P ⁽¹⁾	-	-	
0.47	474	3.15	0.748	1.929	16	-	-	DHT 78P ⁽¹⁾	DHT 78P ⁽¹⁾	DHT 78P ⁽¹⁾	-	-	-	
1	105	3.15	0.748	1.929	16	-	-	DHT 78P ⁽¹⁾	DHT 78P ⁽¹⁾	-	-	-	-	
1.5	155	3.15	0.748	1.929	16	-	-	DHT 78P ⁽¹⁾	-	-	-	-	-	



PHYSICAL CHARACTERISTICS

CONSTRUCTION:

Metal foils, non-inductive.

CASE:

- Composite reconstituted mica
- Epoxy resin impregnated
- Polyester wrapped
- Epoxy resin sealed

MARKING:

Dearborn trademark, type or catalog number, capacitance, tolerance and voltage.

NOTE:

P⁽¹⁾ Premolded capacitor for dielectric fluid use or encapsulation.

ELECTRICAL SPECIFICATIONS

OPERATING TEMPERATURE RANGE:

-55°C to +125°C

DISSIPATION FACTOR:

≤ 0.7% @ 1kHz for CR ≤ 1.5nF
 ≤ 0.5% @ 1kHz for CR > 1.5nF

INSULATION RESISTANCE (IR):

≥ 25,000 MΩ for C_R ≤ 0.22 μF
 ≥ 5,000 MΩ.μF for C_R > 0.22 μF

DIELECTRIC WITHSTANDING VOLTAGE (DWV):

1.6 x rated voltage

INSULATION BETWEEN LEADS & CASE:

25,000 MΩ

CAPACITANCE TOLERANCES AVAILABLE:

±20%, ±10%, ±5%

DIMENSIONS (in inches)

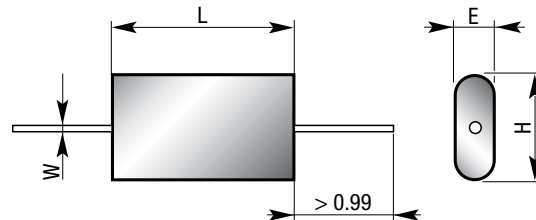

MICA HIGH VOLTAGE CAPACITORS

STANDARD RATINGS

Capacitance		Dimensions (in inches)				TYPE DHT 86									
µF	Code	Max. "L"	Max. "E"	Max. "H"	"W" Gauge	1,500 V	2,500 V	3,500 V	5,000 V	7,500 V	10,000 V	12,500 V	15,000 V	20,000 V	
0.0001	101	1.063	0.197	0.551	18	DHT86	DHT86	DHT86	DHT86	-	-	DHT86	-	-	
0.0047	472	1.063	0.197	0.551	18	DHT86	DHT86	DHT86	DHT86	-	-	-	-	-	
0.01	103	1.063	0.197	0.551	18	DHT86	DHT86	DHT86	-	-	-	-	-	-	
0.015	153	1.063	0.197	0.551	18	DHT86	DHT86	-	-	-	-	-	-	-	
0.022	223	1.063	0.197	0.551	18	DHT86	-	-	-	-	-	-	-	-	
0.00068	681	1.457	0.197	0.473	18	DHT86	DHT86	DHT86	DHT86	DHT86	DHT86	DHT86	-	-	
0.001	102	1.457	0.197	0.473	18	DHT86	DHT86	DHT86	DHT86	DHT86	DHT86	-	-	-	
0.0022	222	1.457	0.197	0.473	18	DHT86	DHT86	DHT86	DHT86	DHT86	-	-	-	-	
0.0068	682	1.457	0.197	0.473	18	DHT86	DHT86	DHT86	DHT86	-	-	-	-	-	
0.015	153	1.457	0.197	0.473	18	DHT86	DHT86	DHT86	-	-	-	-	-	-	
0.022	223	1.457	0.197	0.473	18	DHT86	DHT86	-	-	-	-	-	-	-	
0.033	333	1.457	0.197	0.473	18	DHT86	-	-	-	-	-	-	-	-	
0.00047	471	1.457	0.276	0.551	18	DHT86	DHT86	DHT86	DHT86	DHT86	DHT86	DHT86	DHT86	-	
0.001	102	1.457	0.276	0.551	18	DHT86	DHT86	DHT86	DHT86	DHT86	DHT86	DHT86	-	-	
0.0015	152	1.457	0.276	0.551	18	DHT86	DHT86	DHT86	DHT86	DHT86	DHT86	-	-	-	
0.0033	332	1.457	0.276	0.551	18	DHT86	DHT86	DHT86	DHT86	DHT86	-	-	-	-	
0.01	103	1.457	0.276	0.51	18	DHT86	DHT86	DHT86	DHT86	-	-	-	-	-	
0.022	223	1.457	0.276	0.551	18	DHT86	DHT86	DHT86	-	-	-	-	-	-	
0.033	333	1.457	0.276	0.551	18	DHT86	DHT86	-	-	-	-	-	-	-	
0.047	473	1.457	0.276	0.551	18	DHT86	-	-	-	-	-	-	-	-	
0.00068	681	1.475	0.276	0.709	18	DHT86	DHT86	DHT86	DHT86	DHT86	DHT86	DHT86	DHT86	-	
0.0015	152	1.457	0.276	0.709	18	DHT86	DHT86	DHT86	DHT86	DHT86	DHT86	DHT86	-	-	
0.0022	222	1.457	0.276	0.709	18	DHT86	DHT86	DHT86	DHT86	DHT86	DHT86	-	-	-	
0.0047	472	1.457	0.276	0.709	18	DHT86	DHT86	DHT86	DHT86	DHT86	-	-	-	-	
0.015	153	1.457	0.276	0.709	18	DHT86	DHT86	DHT86	DHT86	-	-	-	-	-	
0.033	333	1.457	0.276	0.709	18	DHT86	DHT86	DHT86	-	-	-	-	-	-	
0.047	473	1.457	0.276	0.709	18	DHT86	DHT86	-	-	-	-	-	-	-	
0.068	683	1.457	0.276	0.709	18	DHT86	-	-	-	-	-	-	-	-	
0.001	102	1.457	0.276	1.024	18	DHT86	DHT86	DHT86	DHT86	DHT86	DHT86	DHT86	DHT86	-	
0.0022	222	1.457	0.276	1.024	18	DHT86	DHT86	DHT86	DHT86	DHT86	DHT86	DHT86	-	-	
0.0033	332	1.457	0.276	1.024	18	DHT86	DHT86	DHT86	DHT86	DHT86	DHT86	-	-	-	
0.0068	682	1.457	0.276	1.024	18	DHT86	DHT86	DHT86	DHT86	DHT86	-	-	-	-	
0.022	223	1.457	0.276	1.024	18	DHT86	DHT86	DHT86	DHT86	-	-	-	-	-	
0.047	473	1.457	0.276	1.024	18	DHT86	DHT86	DHT86	-	-	-	-	-	-	
0.068	683	1.457	0.276	1.024	18	DHT86	DHT86	-	-	-	-	-	-	-	
0.1	104	1.457	0.276	1.024	18	DHT86	-	-	-	-	-	-	-	-	
0.0047	472	1.457	0.355	1.26	18	DHT86	DHT86	DHT86	DHT86	DHT86	DHT86	-	-	-	
0.01	103	1.457	0.355	1.26	18	DHT86	DHT86	DHT86	DHT86	DHT86	-	-	-	-	
0.033	333	1.457	0.355	1.26	18	DHT86	DHT86	DHT86	DHT86	-	-	-	-	-	
0.068	683	1.457	0.355	1.26	18	DHT86	DHT86	DHT86	-	-	-	-	-	-	
0.1	104	1.457	0.355	1.26	18	DHT86	DHT86	-	-	-	-	-	-	-	
0.15	154	1.457	0.355	1.26	18	DHT86	-	-	-	-	-	-	-	-	
0.0068	682	1.457	0.355	1.654	18	DHT86	DHT86	DHT86	DHT86	DHT86	DHT86	-	-	-	
0.015	153	1.457	0.355	1.654	18	DHT86	DHT86	DHT86	DHT86	DHT86	-	-	-	-	
0.047	473	1.457	0.355	1.654	18	DHT86	DHT86	DHT86	DHT86	-	-	-	-	-	
0.1	104	1.457	0.355	1.654	18	DHT86	DHT86	DHT86	-	-	-	-	-	-	
0.15	154	1.457	0.355	1.654	18	DHT86	DHT86	-	-	-	-	-	-	-	
0.22	224	1.457	0.355	1.654	18	DHT86	-	-	-	-	-	-	-	-	
0.00068	681	2.48	0.197	0.866	18	DHT86	DHT86	DHT86	DHT86	DHT86	DHT86	DHT86	DHT86	DHT86	
0.0015	152	2.48	0.197	0.866	18	DHT86	DHT86	DHT86	DHT86	DHT86	DHT86	DHT86	DHT86	-	
0.0033	332	2.48	0.197	0.866	18	DHT86	DHT86	DHT86	DHT86	DHT86	DHT86	DHT86	-	-	
0.001	102	2.48	0.276	0.945	18	DHT86	DHT86	DHT86	DHT86	DHT86	DHT86	DHT86	DHT86	DHT86	
0.0022	222	2.48	0.276	0.945	18	DHT86	DHT86	DHT86	DHT86	DHT86	DHT86	DHT86	DHT86	-	
0.0047	472	2.48	0.276	0.945	18	DHT86	DHT86	DHT86	DHT86	DHT86	DHT86	DHT86	-	-	

MICA HIGH VOLTAGE CAPACITORS

TYPE DHT 86 /
DHT 86P⁽¹⁾

STANDARD RATINGS

Capacitance		Dimensions (in inches)				TYPE DHT 86									
μF	Code	Max. "L"	Max. "E"	Max. "H"	"W" Gauge	1,500 V	2,500 V	3,500 V	5,000 V	7,500 V	10,000 V	12,500 V	15,000 V	20,000 V	
0.0015	152	2.48	0.355	1.024	18	DHT86	DHT86	DHT86	DHT86	DHT86	DHT86	DHT86	DHT86	DHT86	
0.0033	332	2.48	0.355	1.024	18	DHT86	DHT86	DHT86	DHT86	DHT86	DHT86	DHT86	DHT86	-	
0.0068	682	2.48	0.355	1.024	18	DHT86	DHT86	DHT86	DHT86	DHT86	DHT86	DHT86	-	-	
0.01	103	2.48	0.355	1.024	18	DHT86	DHT86	DHT86	DHT86	DHT86	DHT86	-	-	-	
0.022	223	2.48	0.355	1.024	18	DHT86	DHT86	DHT86	DHT86	DHT86	-	-	-	-	
0.068	683	2.48	0.355	1.024	18	DHT86	DHT86	DHT86	DHT86	-	-	-	-	-	
0.15	154	2.48	0.355	1.024	18	DHT86	DHT86	DHT86	-	-	-	-	-	-	
0.33	334	2.48	0.355	1.024	18	DHT86	-	-	-	-	-	-	-	-	
0.0022	222	2.48	0.355	1.575	18	DHT86	DHT86	DHT86	DHT86	DHT86	DHT86	DHT86	DHT86	DHT86	
0.0047	472	2.48	0.355	1.575	18	DHT86	DHT86	DHT86	DHT86	DHT86	DHT86	DHT86	DHT86	-	
0.01	103	2.48	0.355	1.575	18	DHT86	DHT86	DHT86	DHT86	DHT86	DHT86	DHT86	-	-	
0.015	153	2.48	0.355	1.575	18	DHT86	DHT86	DHT86	DHT86	DHT86	DHT86	-	-	-	
0.033	333	2.48	0.355	1.575	18	DHT86	DHT86	DHT86	DHT86	DHT86	-	-	-	-	
0.1	104	2.48	0.355	1.575	18	DHT86	DHT86	DHT86	DHT86	-	-	-	-	-	
0.22	224	2.48	0.355	1.575	18	DHT86	DHT86	-	-	-	-	-	-	-	
0.47	474	2.48	0.355	1.575	18	DHT86	-	-	-	-	-	-	-	-	
0.0033	332	2.48	0.355	1.851	18	DHT86	DHT86	DHT86	DHT86	DHT86	DHT86	DHT86	DHT86	DHT86	
0.0068	682	2.48	0.355	1.851	18	DHT86	DHT86	DHT86	DHT86	DHT86	DHT86	DHT86	DHT86	-	
0.015	153	2.48	0.355	1.851	18	DHT86	DHT86	DHT86	DHT86	DHT86	DHT86	DHT86	-	-	
0.022	223	2.48	0.355	1.851	18	DHT86	DHT86	DHT86	DHT86	DHT86	DHT86	DHT86	-	-	
0.047	473	2.48	0.355	1.851	18	DHT86	DHT86	DHT86	DHT86	DHT86	-	-	-	-	
0.22	224	2.48	0.355	1.851	18	DHT86	DHT86	DHT86	-	-	-	-	-	-	
0.33	334	2.48	0.355	1.851	18	DHT86	DHT86	-	-	-	-	-	-	-	
0.0047	472	3.189	0.355	1.851	16	DHT86	DHT86	DHT86	DHT86	DHT86	DHT86	DHT86	DHT86	DHT86	
0.01	103	3.189	0.355	1.851	16	DHT86	DHT86	DHT86	DHT86	DHT86	DHT86	DHT86	DHT86	-	
0.022	223	3.189	0.355	1.851	16	DHT86	DHT86	DHT86	DHT86	DHT86	DHT86	DHT86	DHT86	-	
0.033	333	3.189	0.355	1.851	16	DHT86	DHT86	DHT86	DHT86	DHT86	DHT86	-	-	-	
0.068	683	3.189	0.355	1.851	16	DHT86	DHT86	DHT86	DHT86	DHT86	-	-	-	-	
0.15	154	3.189	0.355	1.851	16	DHT86	DHT86	DHT86	DHT86	-	-	-	-	-	
0.33	334	3.189	0.355	1.851	16	DHT86	DHT86	DHT86	-	-	-	-	-	-	
0.47	474	3.189	0.355	1.851	16	DHT86	DHT86	-	-	-	-	-	-	-	
0.68	684	3.189	0.355	1.851	16	DHT86	-	-	-	-	-	-	-	-	
0.0068	682	3.189	0.433	1.292	16	DHT86	DHT86	DHT86	DHT86	DHT86	DHT86	DHT86	DHT86	DHT86	
0.015	153	3.189	0.433	1.929	16	DHT86	DHT86	DHT86	DHT86	DHT86	DHT86	DHT86	DHT86	-	
0.033	333	3.189	0.433	1.929	16	DHT86	DHT86	DHT86	DHT86	DHT86	DHT86	DHT86	-	-	
0.047	473	3.189	0.433	1.929	16	DHT86	DHT86	DHT86	DHT86	DHT86	DHT86	-	-	-	
0.1	104	3.189	0.433	1.929	16	DHT86	DHT86	DHT86	DHT86	DHT86	-	-	-	-	
0.22	224	3.189	0.433	1.929	16	DHT86	DHT86	DHT86	DHT86	-	-	-	-	-	
0.47	474	3.189	0.433	1.929	16	DHT86	DHT86	DHT86	-	-	-	-	-	-	
0.68	684	3.189	0.433	1.929	16	DHT86	DHT86	-	-	-	-	-	-	-	
1	105	3.189	0.433	1.929	16	DHT86	-	-	-	-	-	-	-	-	
0.01	103	4.213	0.433	1.929	16	DHT86	DHT86	DHT86	DHT86	DHT86	DHT86	DHT86	DHT86	DHT86	
0.022	223	4.213	0.433	1.929	16	DHT86	DHT86	DHT86	DHT86	DHT86	DHT86	DHT86	DHT86	-	
0.047	473	4.213	0.433	1.929	16	DHT86	DHT86	DHT86	DHT86	DHT86	DHT86	DHT86	-	-	
0.068	683	4.213	0.433	1.929	16	DHT86	DHT86	DHT86	DHT86	DHT86	DHT86	-	-	-	
0.15	154	4.213	0.433	1.929	16	DHT86	DHT86	DHT86	DHT86	DHT86	-	-	-	-	
0.33	334	4.213	0.433	1.929	16	DHT86	DHT86	DHT86	DHT86	-	-	-	-	-	
0.68	684	4.213	0.433	1.929	16	DHT86	DHT86	DHT86	-	-	-	-	-	-	
1	105	4.213	0.433	1.929	16	DHT86	DHT86	-	-	-	-	-	-	-	
1.5	155	4.213	0.433	1.929	16	DHT86	-	-	-	-	-	-	-	-	

MICA HIGH VOLTAGE CAPACITORS

STANDARD RATINGS

Capacitance		Dimensions (in inches)				TYPE DHT 86									
µF	Code	Max. "L"	Max. "E"	Max. "H"	"W" Gauge	1,500 V	2,500 V	3,500 V	5,000 V	7,500 V	10,000 V	12,500 V	15,000 V	20,000 V	
0.015	153	4.213	0.63	2.047	16	DHT86	DHT86	DHT86	DHT86	DHT86	DHT86	DHT86	DHT86	DHT86	
0.033	333	4.213	0.63	2.047	16	DHT86	DHT86	DHT86	DHT86	DHT86	DHT86	DHT86	DHT86	-	
0.068	683	4.213	0.63	2.047	16	DHT86	DHT86	DHT86	DHT86	DHT86	DHT86	DHT86	DHT86	-	
0.1	104	4.213	0.63	2.047	16	DHT86	DHT86	DHT86	DHT86	DHT86	DHT86	-	-	-	
0.22	224	4.213	0.63	2.047	16	DHT86	DHT86	DHT86	DHT86	DHT86	-	-	-	-	
0.47	474	4.213	0.63	2.047	16	DHT86	DHT86	DHT86	DHT86	-	-	-	-	-	
1	105	4.213	0.63	2.047	16	DHT86	DHT86	DHT86	-	-	-	-	-	-	
1.5	155	4.213	0.63	2.047	16	DHT86	DHT86	-	-	-	-	-	-	-	
2.2	225	4.213	0.63	2.047	16	DHT86	-	-	-	-	-	-	-	-	

STANDARD RATINGS

Capacitance		Dimensions (in inches)				TYPE DHT 86P(1)									
µF	Code	Max. "L"	Max. "E"	Max. "H"	"W" Gauge	1,500 V	2,500 V	3,500 V	5,000 V	7,500 V	10,000 V	12,500 V	15,000 V	20,000 V	
0.0001	101	1.024	0.197	0.512	18	DHT 86P(1)	DHT 86P(1)	DHT 86P(1)	DHT 86P(1)	DHT 86P(1)	DHT 86P(1)	DHT 86P(1)	-	-	
0.0047	472	1.024	0.197	0.512	18	DHT 86P(1)	DHT 86P(1)	DHT 86P(1)	DHT 86P(1)	-	-	-	-	-	
0.01	103	1.024	0.197	0.512	18	DHT 86P(1)	DHT 86P(1)	DHT 86P(1)	-	-	-	-	-	-	
0.015	153	1.024	0.197	0.512	18	DHT 86P(1)	DHT 86P(1)	-	-	-	-	-	-	-	
0.022	223	1.024	0.197	0.512	18	DHT 86P(1)	-	-	-	-	-	-	-	-	
0.00068	681	1.418	0.197	0.433	18	DHT 86P(1)	DHT 86P(1)	DHT 86P(1)	DHT 86P(1)	DHT 86P(1)	DHT 86P(1)	DHT 86P(1)	-	-	
0.001	102	1.418	0.197	0.433	18	DHT 86P(1)	DHT 86P(1)	DHT 86P(1)	DHT 86P(1)	DHT 86P(1)	DHT 86P(1)	-	-	-	
0.0022	222	1.418	0.197	0.433	18	DHT 86P(1)	DHT 86P(1)	DHT 86P(1)	DHT 86P(1)	DHT 86P(1)	-	-	-	-	
0.0068	682	1.418	0.197	0.433	18	DHT 86P(1)	DHT 86P(1)	DHT 86P(1)	DHT 86P(1)	-	-	-	-	-	
0.015	153	1.418	0.197	0.433	18	DHT 86P(1)	DHT 86P(1)	DHT 86P(1)	-	-	-	-	-	-	
0.022	223	1.418	0.197	0.433	18	DHT 86P(1)	DHT 86P(1)	-	-	-	-	-	-	-	
0.033	333	1.418	0.197	0.433	18	DHT 86P(1)	-	-	-	-	-	-	-	-	
0.00047	471	1.418	0.276	0.512	18	DHT 86P(1)	DHT 86P(1)	DHT 86P(1)	DHT 86P(1)	DHT 86P(1)	DHT 86P(1)	DHT 86P(1)	DHT 86P(1)	-	
0.001	102	1.418	0.276	0.512	18	DHT 86P(1)	DHT 86P(1)	DHT 86P(1)	DHT 86P(1)	DHT 86P(1)	DHT 86P(1)	DHT 86P(1)	-	-	
0.0015	152	1.418	0.276	0.512	18	DHT 86P(1)	DHT 86P(1)	DHT 86P(1)	DHT 86P(1)	DHT 86P(1)	DHT 86P(1)	-	-	-	
0.0033	332	1.418	0.276	0.512	18	DHT 86P(1)	DHT 86P(1)	DHT 86P(1)	DHT 86P(1)	DHT 86P(1)	-	-	-	-	
0.01	103	1.418	0.276	0.512	18	DHT 86P(1)	DHT 86P(1)	DHT 86P(1)	DHT 86P(1)	-	-	-	-	-	
0.022	223	1.418	0.276	0.512	18	DHT 86P(1)	DHT 86P(1)	DHT 86P(1)	-	-	-	-	-	-	
0.033	333	1.418	0.276	0.512	18	DHT 86P(1)	DHT 86P(1)	-	-	-	-	-	-	-	
0.047	473	1.418	0.276	0.512	18	DHT 86P(1)	-	-	-	-	-	-	-	-	
0.00068	681	1.418	0.276	0.67	18	DHT 86P(1)	DHT 86P(1)	DHT 86P(1)	DHT 86P(1)	DHT 86P(1)	DHT 86P(1)	DHT 86P(1)	DHT 86P(1)	-	
0.0015	152	1.418	0.276	0.67	18	DHT 86P(1)	DHT 86P(1)	DHT 86P(1)	DHT 86P(1)	DHT 86P(1)	DHT 86P(1)	DHT 86P(1)	-	-	
0.0022	222	1.418	0.276	0.67	18	DHT 86P(1)	DHT 86P(1)	DHT 86P(1)	DHT 86P(1)	DHT 86P(1)	DHT 86P(1)	-	-	-	
0.0047	472	1.418	0.276	0.67	18	DHT 86P(1)	DHT 86P(1)	DHT 86P(1)	DHT 86P(1)	DHT 86P(1)	-	-	-	-	
0.015	153	1.418	0.276	0.67	18	DHT 86P(1)	DHT 86P(1)	DHT 86P(1)	DHT 86P(1)	-	-	-	-	-	
0.033	333	1.418	0.276	0.67	18	DHT 86P(1)	DHT 86P(1)	DHT 86P(1)	-	-	-	-	-	-	
0.047	473	1.418	0.276	0.67	18	DHT 86P(1)	DHT 86P(1)	-	-	-	-	-	-	-	
0.068	683	1.418	0.276	0.67	18	DHT 86P(1)	-	-	-	-	-	-	-	-	
0.001	102	1.418	0.276	0.984	18	DHT 86P(1)	DHT 86P(1)	DHT 86P(1)	DHT 86P(1)	DHT 86P(1)	DHT 86P(1)	DHT 86P(1)	DHT 86P(1)	-	
0.0022	222	1.418	0.276	0.984	18	DHT 86P(1)	DHT 86P(1)	DHT 86P(1)	DHT 86P(1)	DHT 86P(1)	DHT 86P(1)	DHT 86P(1)	-	-	
0.0033	332	1.418	0.276	0.984	18	DHT 86P(1)	DHT 86P(1)	DHT 86P(1)	DHT 86P(1)	DHT 86P(1)	DHT 86P(1)	-	-	-	
0.0068	682	1.418	0.276	0.984	18	DHT 86P(1)	DHT 86P(1)	DHT 86P(1)	DHT 86P(1)	DHT 86P(1)	-	-	-	-	
0.022	223	1.418	0.276	0.984	18	DHT 86P(1)	DHT 86P(1)	DHT 86P(1)	DHT 86P(1)	-	-	-	-	-	
0.047	473	1.418	0.276	0.984	18	DHT 86P(1)	DHT 86P(1)	DHT 86P(1)	-	-	-	-	-	-	
0.068	683	1.418	0.276	0.984	18	DHT 86P(1)	DHT 86P(1)	-	-	-	-	-	-	-	
0.1	104	1.418	0.276	0.984	18	DHT 86P(1)	-	-	-	-	-	-	-	-	

Note: P(1) Premolded Capacitor for Dielectric Fluid use or Encapsulation.

MICA HIGH VOLTAGE CAPACITORS

TYPE DHT 86 /
DHT 86P⁽¹⁾

STANDARD RATINGS

Capacitance		Dimensions (in inches)				TYPE DHT 86 ⁽¹⁾									
μF	Code	Max. "L"	Max. "E"	Max. "H"	"W" Gauge	1,500 V	2,500 V	3,500 V	5,000 V	7,500 V	10,000 V	12,500 V	15,000 V	20,000 V	
0.0047	472	1.418	0.355	1.221	18	DHT 86P ⁽¹⁾	DHT 86P ⁽¹⁾	DHT 86P ⁽¹⁾	DHT 86P ⁽¹⁾	DHT 86P ⁽¹⁾	DHT 86P ⁽¹⁾	-	-	-	
0.01	103	1.418	0.355	1.221	18	DHT 86P ⁽¹⁾	DHT 86P ⁽¹⁾	DHT 86P ⁽¹⁾	DHT 86P ⁽¹⁾	DHT 86P ⁽¹⁾	-	-	-	-	
0.033	333	1.418	0.355	1.221	18	DHT 86P ⁽¹⁾	DHT 86P ⁽¹⁾	DHT 86P ⁽¹⁾	DHT 86P ⁽¹⁾	DHT 86P ⁽¹⁾	-	-	-	-	
0.068	683	1.418	0.355	1.221	18	DHT 86P ⁽¹⁾	DHT 86P ⁽¹⁾	DHT 86P ⁽¹⁾	-	-	-	-	-	-	
0.1	104	1.418	0.355	1.221	18	DHT 86P ⁽¹⁾	DHT 86P ⁽¹⁾	-	-	-	-	-	-	-	
0.15	154	1.418	0.355	1.221	18	DHT 86P ⁽¹⁾	-	-	-	-	-	-	-	-	
0.0068	682	1.418	0.355	1.614	18	DHT 86P ⁽¹⁾	DHT 86P ⁽¹⁾	DHT 86P ⁽¹⁾	DHT 86P ⁽¹⁾	DHT 86P ⁽¹⁾	DHT 86P ⁽¹⁾	-	-	-	
0.015	153	1.418	0.355	1.614	18	DHT 86P ⁽¹⁾	DHT 86P ⁽¹⁾	DHT 86P ⁽¹⁾	DHT 86P ⁽¹⁾	DHT 86P ⁽¹⁾	-	-	-	-	
0.047	473	1.418	0.355	1.614	18	DHT 86P ⁽¹⁾	DHT 86P ⁽¹⁾	DHT 86P ⁽¹⁾	DHT 86P ⁽¹⁾	-	-	-	-	-	
0.1	104	1.418	0.355	1.614	18	DHT 86P ⁽¹⁾	DHT 86P ⁽¹⁾	DHT 86P ⁽¹⁾	-	-	-	-	-	-	
0.15	154	1.418	0.355	1.614	18	DHT 86P ⁽¹⁾	DHT 86P ⁽¹⁾	-	-	-	-	-	-	-	
0.22	224	1.418	0.355	1.614	18	DHT 86P ⁽¹⁾	-	-	-	-	-	-	-	-	
0.00068	681	2.441	0.197	0.827	18	DHT 86P ⁽¹⁾	DHT 86P ⁽¹⁾	DHT 86P ⁽¹⁾	DHT 86P ⁽¹⁾	DHT 86P ⁽¹⁾	DHT 86P ⁽¹⁾	DHT 86P ⁽¹⁾	DHT 86P ⁽¹⁾	DHT 86P ⁽¹⁾	
0.0015	152	2.441	0.197	0.827	18	DHT 86P ⁽¹⁾	DHT 86P ⁽¹⁾	DHT 86P ⁽¹⁾	DHT 86P ⁽¹⁾	DHT 86P ⁽¹⁾	DHT 86P ⁽¹⁾	DHT 86P ⁽¹⁾	DHT 86P ⁽¹⁾	DHT 86P ⁽¹⁾	
0.0033	332	2.441	0.197	0.827	18	DHT 86P ⁽¹⁾	DHT 86P ⁽¹⁾	DHT 86P ⁽¹⁾	DHT 86P ⁽¹⁾	DHT 86P ⁽¹⁾	DHT 86P ⁽¹⁾	DHT 86P ⁽¹⁾	-	-	
0.001	102	2.441	0.276	0.906	18	DHT 86P ⁽¹⁾	DHT 86P ⁽¹⁾	DHT 86P ⁽¹⁾	DHT 86P ⁽¹⁾	DHT 86P ⁽¹⁾	DHT 86P ⁽¹⁾	DHT 86P ⁽¹⁾	DHT 86P ⁽¹⁾	DHT 86P ⁽¹⁾	
0.0022	222	2.441	0.276	0.906	18	DHT 86P ⁽¹⁾	DHT 86P ⁽¹⁾	DHT 86P ⁽¹⁾	DHT 86P ⁽¹⁾	DHT 86P ⁽¹⁾	DHT 86P ⁽¹⁾	DHT 86P ⁽¹⁾	DHT 86P ⁽¹⁾	-	
0.0047	472	2.441	0.276	0.906	18	DHT 86P ⁽¹⁾	DHT 86P ⁽¹⁾	DHT 86P ⁽¹⁾	DHT 86P ⁽¹⁾	DHT 86P ⁽¹⁾	DHT 86P ⁽¹⁾	DHT 86P ⁽¹⁾	-	-	
0.0015	152	2.441	0.355	0.984	18	DHT 86P ⁽¹⁾	DHT 86P ⁽¹⁾	DHT 86P ⁽¹⁾	DHT 86P ⁽¹⁾	DHT 86P ⁽¹⁾	DHT 86P ⁽¹⁾	DHT 86P ⁽¹⁾	DHT 86P ⁽¹⁾	DHT 86P ⁽¹⁾	
0.0033	332	2.441	0.355	0.984	18	DHT 86P ⁽¹⁾	DHT 86P ⁽¹⁾	DHT 86P ⁽¹⁾	DHT 86P ⁽¹⁾	DHT 86P ⁽¹⁾	DHT 86P ⁽¹⁾	DHT 86P ⁽¹⁾	DHT 86P ⁽¹⁾	DHT 86P ⁽¹⁾	
0.0068	682	2.441	0.355	0.984	18	DHT 86P ⁽¹⁾	DHT 86P ⁽¹⁾	DHT 86P ⁽¹⁾	DHT 86P ⁽¹⁾	DHT 86P ⁽¹⁾	DHT 86P ⁽¹⁾	DHT 86P ⁽¹⁾	-	-	
0.01	103	2.441	0.355	0.984	18	DHT 86P ⁽¹⁾	DHT 86P ⁽¹⁾	DHT 86P ⁽¹⁾	DHT 86P ⁽¹⁾	DHT 86P ⁽¹⁾	DHT 86P ⁽¹⁾	-	-	-	
0.022	223	2.441	0.355	0.984	18	DHT 86P ⁽¹⁾	DHT 86P ⁽¹⁾	DHT 86P ⁽¹⁾	DHT 86P ⁽¹⁾	DHT 86P ⁽¹⁾	-	-	-	-	
0.068	683	2.441	0.355	0.984	18	DHT 86P ⁽¹⁾	DHT 86P ⁽¹⁾	DHT 86P ⁽¹⁾	DHT 86P ⁽¹⁾	-	-	-	-	-	
0.015	153	2.441	0.355	0.984	18	DHT 86P ⁽¹⁾	DHT 86P ⁽¹⁾	DHT 86P ⁽¹⁾	-	-	-	-	-	-	
0.033	333	2.441	0.355	0.984	18	DHT 86P ⁽¹⁾	-	-	-	-	-	-	-	-	
0.0022	222	2.441	0.355	1.536	18	DHT 86P ⁽¹⁾	DHT 86P ⁽¹⁾	DHT 86P ⁽¹⁾	DHT 86P ⁽¹⁾	DHT 86P ⁽¹⁾	DHT 86P ⁽¹⁾	DHT 86P ⁽¹⁾	DHT 86P ⁽¹⁾	DHT 86P ⁽¹⁾	
0.0047	472	2.441	0.355	1.536	18	DHT 86P ⁽¹⁾	DHT 86P ⁽¹⁾	DHT 86P ⁽¹⁾	DHT 86P ⁽¹⁾	DHT 86P ⁽¹⁾	DHT 86P ⁽¹⁾	DHT 86P ⁽¹⁾	DHT 86P ⁽¹⁾	-	
0.01	103	2.441	0.355	1.536	18	DHT 86P ⁽¹⁾	DHT 86P ⁽¹⁾	DHT 86P ⁽¹⁾	DHT 86P ⁽¹⁾	DHT 86P ⁽¹⁾	DHT 86P ⁽¹⁾	DHT 86P ⁽¹⁾	-	-	
0.015	153	2.441	0.355	1.536	18	DHT 86P ⁽¹⁾	DHT 86P ⁽¹⁾	DHT 86P ⁽¹⁾	DHT 86P ⁽¹⁾	DHT 86P ⁽¹⁾	DHT 86P ⁽¹⁾	-	-	-	
0.033	335	2.441	0.355	1.536	18	DHT 86P ⁽¹⁾	DHT 86P ⁽¹⁾	DHT 86P ⁽¹⁾	DHT 86P ⁽¹⁾	DHT 86P ⁽¹⁾	-	-	-	-	
0.1	104	2.441	0.355	1.536	18	DHT 86P ⁽¹⁾	DHT 86P ⁽¹⁾	DHT 86P ⁽¹⁾	DHT 86P ⁽¹⁾	-	-	-	-	-	
0.22	224	2.441	0.355	1.536	18	DHT 86P ⁽¹⁾	DHT 86P ⁽¹⁾	-	-	-	-	-	-	-	
0.47	474	2.441	0.355	1.536	18	DHT 86P ⁽¹⁾	-	-	-	-	-	-	-	-	
0.0033	332	2.441	0.355	1.811	18	DHT 86P ⁽¹⁾	DHT 86P ⁽¹⁾	DHT 86P ⁽¹⁾	DHT 86P ⁽¹⁾	DHT 86P ⁽¹⁾	DHT 86P ⁽¹⁾	DHT 86P ⁽¹⁾	DHT 86P ⁽¹⁾	DHT 86P ⁽¹⁾	
0.0068	682	2.441	0.355	1.811	18	DHT 86P ⁽¹⁾	DHT 86P ⁽¹⁾	DHT 86P ⁽¹⁾	DHT 86P ⁽¹⁾	DHT 86P ⁽¹⁾	DHT 86P ⁽¹⁾	DHT 86P ⁽¹⁾	DHT 86P ⁽¹⁾	-	
0.015	153	2.441	0.355	1.811	18	DHT 86P ⁽¹⁾	DHT 86P ⁽¹⁾	DHT 86P ⁽¹⁾	DHT 86P ⁽¹⁾	DHT 86P ⁽¹⁾	DHT 86P ⁽¹⁾	DHT 86P ⁽¹⁾	DHT 86P ⁽¹⁾	-	
0.022	223	2.441	0.355	1.811	18	DHT 86P ⁽¹⁾	DHT 86P ⁽¹⁾	DHT 86P ⁽¹⁾	DHT 86P ⁽¹⁾	DHT 86P ⁽¹⁾	DHT 86P ⁽¹⁾	-	-	-	
0.047	473	2.441	0.355	1.811	18	DHT 86P ⁽¹⁾	DHT 86P ⁽¹⁾	DHT 86P ⁽¹⁾	DHT 86P ⁽¹⁾	DHT 86P ⁽¹⁾	-	-	-	-	
0.022	223	2.441	0.355	1.811	18	DHT 86P ⁽¹⁾	DHT 86P ⁽¹⁾	DHT 86P ⁽¹⁾	DHT 86P ⁽¹⁾	-	-	-	-	-	
0.033	333	2.441	0.355	1.811	18	DHT 86P ⁽¹⁾	DHT 86P ⁽¹⁾	DHT 86P ⁽¹⁾	-	-	-	-	-	-	
0.0047	472	3.15	0.355	1.811	16	DHT 86P ⁽¹⁾	DHT 86P ⁽¹⁾	DHT 86P ⁽¹⁾	DHT 86P ⁽¹⁾	DHT 86P ⁽¹⁾	DHT 86P ⁽¹⁾	DHT 86P ⁽¹⁾	DHT 86P ⁽¹⁾	DHT 86P ⁽¹⁾	
0.01	103	3.15	0.355	1.811	16	DHT 86P ⁽¹⁾	DHT 86P ⁽¹⁾	DHT 86P ⁽¹⁾	DHT 86P ⁽¹⁾	DHT 86P ⁽¹⁾	DHT 86P ⁽¹⁾	DHT 86P ⁽¹⁾	DHT 86P ⁽¹⁾	DHT 86P ⁽¹⁾	
0.022	223	3.15	0.355	1.811	16	DHT 86P ⁽¹⁾	DHT 86P ⁽¹⁾	DHT 86P ⁽¹⁾	DHT 86P ⁽¹⁾	DHT 86P ⁽¹⁾	DHT 86P ⁽¹⁾	DHT 86P ⁽¹⁾	-	-	
0.033	333	3.15	0.355	1.811	16	DHT 86P ⁽¹⁾	DHT 86P ⁽¹⁾	DHT 86P ⁽¹⁾	DHT 86P ⁽¹⁾	DHT 86P ⁽¹⁾	DHT 86P ⁽¹⁾	-	-	-	
0.068	683	3.15	0.355	1.811	16	DHT 86P ⁽¹⁾	DHT 86P ⁽¹⁾	DHT 86P ⁽¹⁾	DHT 86P ⁽¹⁾	DHT 86P ⁽¹⁾	-	-	-	-	
0.15	154	3.15	0.355	1.811	16	DHT 86P ⁽¹⁾	DHT 86P ⁽¹⁾	DHT 86P ⁽¹⁾	DHT 86P ⁽¹⁾	-	-	-	-	-	
0.33	334	3.15	0.355	1.811	16	DHT 86P ⁽¹⁾	DHT 86P ⁽¹⁾	-	-	-	-	-	-	-	
0.47	474	3.15	0.355	1.811	16	DHT 86P ⁽¹⁾	-	-	-	-	-	-	-	-	
0.68	684	3.15	0.355	1.811	16	DHT 86P ⁽¹⁾	-	-	-	-	-	-	-	-	

Note: P(1) Premolded Capacitor for Dielectric Fluid use or Encapsulation.

MICA HIGH VOLTAGE CAPACITORS

STANDARD RATINGS

Capacitance		Dimensions (in inches)				TYPE DHT 86P(1)									
µF	Code	Max. "L"	Max. "E"	Max. "H"	"W" Gauge	1,500 V	2,500 V	3,500 V	5,000 V	7,500 V	10,000 V	12,500 V	15,000 V	20,000 V	
0.0068	682	3.15	0.433	1.89	16	DHT 86P(1)	DHT 86P(1)	DHT 86P(1)	DHT 86P(1)	DHT 86P(1)	DHT 86P(1)	DHT 86P(1)	DHT 86P(1)	DHT 86P(1)	
0.015	153	3.15	0.433	1.89	16	DHT 86P(1)	DHT 86P(1)	DHT 86P(1)	DHT 86P(1)	DHT 86P(1)	DHT 86P(1)	DHT 86P(1)	DHT 86P(1)	-	
0.033	333	3.15	0.433	1.89	16	DHT 86P(1)	DHT 86P(1)	DHT 86P(1)	DHT 86P(1)	DHT 86P(1)	DHT 86P(1)	DHT 86P(1)	DHT 86P(1)	-	
0.047	473	3.15	0.433	1.89	16	DHT 86P(1)	DHT 86P(1)	DHT 86P(1)	DHT 86P(1)	DHT 86P(1)	DHT 86P(1)	-	-	-	
0.1	104	3.15	0.433	1.89	16	DHT 86P(1)	DHT 86P(1)	DHT 86P(1)	DHT 86P(1)	DHT 86P(1)	-	-	-	-	
0.22	224	3.15	0.433	1.89	16	DHT 86P(1)	DHT 86P(1)	DHT 86P(1)	DHT 86P(1)	-	-	-	-	-	
0.47	474	3.15	0.433	1.89	16	DHT 86P(1)	DHT 86P(1)	DHT 86P(1)	-	-	-	-	-	-	
0.68	684	3.15	0.433	1.89	16	DHT 86P(1)	DHT 86P(1)	-	-	-	-	-	-	-	
1	105	3.15	0.433	1.89	16	DHT 86P(1)	-	-	-	-	-	-	-	-	
0.01	103	4.173	0.433	1.89	16	DHT 86P(1)	DHT 86P(1)	DHT 86P(1)	DHT 86P(1)	DHT 86P(1)	DHT 86P(1)	DHT 86P(1)	DHT 86P(1)	DHT 86P(1)	
0.022	223	4.173	0.433	1.89	16	DHT 86P(1)	DHT 86P(1)	DHT 86P(1)	DHT 86P(1)	DHT 86P(1)	DHT 86P(1)	DHT 86P(1)	DHT 86P(1)	-	
0.047	473	4.173	0.433	1.89	16	DHT 86P(1)	DHT 86P(1)	DHT 86P(1)	DHT 86P(1)	DHT 86P(1)	DHT 86P(1)	DHT 86P(1)	-	-	
0.068	683	4.173	0.433	1.89	16	DHT 86P(1)	DHT 86P(1)	DHT 86P(1)	DHT 86P(1)	DHT 86P(1)	DHT 86P(1)	-	-	-	
0.15	154	4.173	0.433	1.89	16	DHT 86P(1)	DHT 86P(1)	DHT 86P(1)	DHT 86P(1)	DHT 86P(1)	-	-	-	-	
0.33	334	4.173	0.433	1.89	16	DHT 86P(1)	DHT 86P(1)	DHT 86P(1)	DHT 86P(1)	-	-	-	-	-	
0.68	684	4.173	0.433	1.89	16	DHT 86P(1)	DHT 86P(1)	DHT 86P(1)	-	-	-	-	-	-	
1	105	4.173	0.433	1.89	16	DHT 86P(1)	DHT 86P(1)	-	-	-	-	-	-	-	
1.5	155	4.173	0.433	1.89	16	DHT 86P(1)	-	-	-	-	-	-	-	-	
0.015	153	4.173	0.591	2.01	16	DHT 86P(1)	DHT 86P(1)	DHT 86P(1)	DHT 86P(1)	DHT 86P(1)	DHT 86P(1)	DHT 86P(1)	DHT 86P(1)	DHT 86P(1)	
0.033	333	4.173	0.591	2.01	16	DHT 86P(1)	DHT 86P(1)	DHT 86P(1)	DHT 86P(1)	DHT 86P(1)	DHT 86P(1)	DHT 86P(1)	DHT 86P(1)	-	
0.068	683	4.173	0.591	2.01	16	DHT 86P(1)	DHT 86P(1)	DHT 86P(1)	DHT 86P(1)	DHT 86P(1)	DHT 86P(1)	DHT 86P(1)	-	-	
0.1	104	4.173	0.591	2.01	16	DHT 86P(1)	DHT 86P(1)	DHT 86P(1)	DHT 86P(1)	DHT 86P(1)	DHT 86P(1)	-	-	-	
0.22	224	4.173	0.591	2.01	16	DHT 86P(1)	DHT 86P(1)	DHT 86P(1)	DHT 86P(1)	DHT 86P(1)	-	-	-	-	
0.47	474	4.173	0.591	2.01	16	DHT 86P(1)	DHT 86P(1)	DHT 86P(1)	DHT 86P(1)	-	-	-	-	-	
1	105	4.173	0.591	2.01	16	DHT 86P(1)	DHT 86P(1)	DHT 86P(1)	-	-	-	-	-	-	
1.5	155	4.173	0.591	2.01	16	DHT 86P(1)	DHT 86P(1)	-	-	-	-	-	-	-	
2.2	225	4.173	0.591	2.01	16	DHT 86P(1)	-	-	-	-	-	-	-	-	

Note: P(1) Premolded Capacitor for Dielectric Fluid use or Encapsulation.

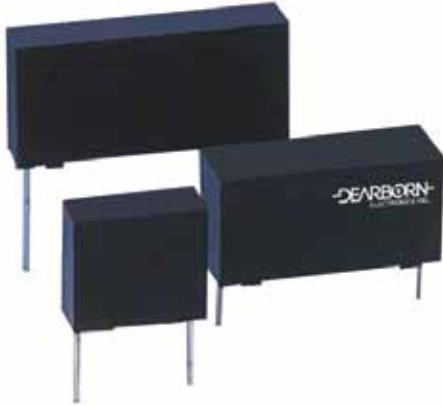

PHYSICAL CHARACTERISTICS

CONSTRUCTION:

Metal foils, non-inductive.

CASE:

- Dielectric: composite reconstituted mica
- Epoxy resin impregnated
- Epoxy resin molded
- Radial leads

MARKING:

Dearborn trademark, type or catalog number, capacitance, tolerance and voltage.

ELECTRICAL SPECIFICATIONS

OPERATING TEMPERATURE RANGE:

-55°C to +125°C

DISSIPATION FACTOR:

≤ 0.7% @ 1kHz for $C_R \leq 1.5\text{nF}$

≤ 0.5% @ 1kHz for $C_R > 1.5\text{nF}$

INSULATION RESISTANCE (IR):

≥ 25,000 MΩ at < 500 VDC

DIELECTRIC WITHSTANDING VOLTAGE (DWV):

1.4 x rated voltage

INSULATION BETWEEN LEADS & CASE:

25,000 MΩ

CAPACITANCE TOLERANCES AVAILABLE:

±20% and ±10%

DIMENSIONS (in inches)

Model	L Max.	E Max.	H Max.	X +/- 0.02
DHT 96-1	0.807	0.256	0.768	0.701
DHT 96-2	0.807	0.315	0.768	0.701
DHT 96-3	1.28	0.256	0.847	1.1
DHT 96-4	1.28	0.355	0.847	1.1
DHT 96-5	1.791	0.256	0.925	1.6
DHT 96-6	1.791	0.355	0.925	1.6

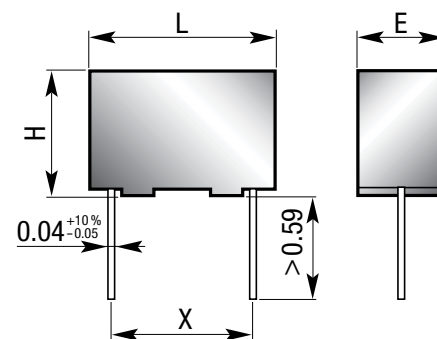

MICA HIGH VOLTAGE CAPACITORS

STANDARD RATINGS

Capacitance		3,000 VDC	4,000 VDC	5,000 VDC	7,500 VDC	10,000 VDC
μ F	Code					
0.001	102	DHT 96-1	DHT 96-1	DHT 96-1	DHT 96-1	DHT 96-1
0.0012	122	DHT 96-1	DHT 96-1	DHT 96-1	DHT 96-1	DHT 96-1
0.0015	152	DHT 96-1	DHT 96-1	DHT 96-1	DHT 96-1	-
0.0018	182	DHT 96-1	DHT 96-1	DHT 96-1	DHT 96-1	-
0.0022	122	DHT 96-1	DHT 96-1	DHT 96-1	DHT 96-1	-
0.0027	272	DHT 96-1	DHT 96-1	DHT 96-1	DHT 96-1	-
0.0039	392	DHT 96-1	DHT 96-1	DHT 96-1	-	-
0.0047	472	DHT 96-1	DHT 96-1	DHT 96-1	-	-
0.005	502	DHT 96-1	DHT 96-1	DHT 96-1	-	-
0.0056	5602	DHT 96-1	DHT 96-1	DHT 96-1	-	-
0.0068	682	DHT 96-1	DHT 96-1	DHT 96-1	-	-
0.0082	822	DHT 96-1	DHT 96-1	DHT 96-1	-	-
0.01	103	DHT 96-1	DHT 96-1	DHT 96-1	-	-
0.012	123	DHT 96-1	DHT 96-1	-	-	-
0.015	153	DHT 96-1	DHT 96-1	-	-	-
0.018	183	DHT 96-1	-	-	-	-
0.02	203	DHT 96-1	-	-	-	-
0.022	223	DHT 96-1	-	-	-	-
0.001	102	DHT 96-2	DHT 96-2	DHT 96-2	DHT 96-2	DHT 96-2
0.0012	122	DHT 96-2	DHT 96-2	DHT 96-2	DHT 96-2	DHT 96-2
0.0015	152	DHT 96-2	DHT 96-2	DHT 96-2	DHT 96-2	DHT 96-2
0.0018	182	DHT 96-2	DHT 96-2	DHT 96-2	DHT 96-2	DHT 96-2
0.0022	122	DHT 96-2	DHT 96-2	DHT 96-2	DHT 96-2	-
0.0027	272	DHT 96-2	DHT 96-2	DHT 96-2	DHT 96-2	-
0.0033	332	DHT 96-2	DHT 96-2	DHT 96-2	DHT 96-2	-
0.0039	392	DHT 96-2	DHT 96-2	DHT 96-2	DHT 96-2	-
0.0047	472	DHT 96-2	DHT 96-2	DHT 96-2	-	-
0.005	502	DHT 96-2	DHT 96-2	DHT 96-2	-	-
0.0056	562	DHT 96-2	DHT 96-2	DHT 96-2	-	-
0.0068	682	DHT 96-2	DHT 96-2	DHT 96-2	-	-
0.0082	822	DHT 96-2	DHT 96-2	DHT 96-2	-	-
0.01	103	DHT 96-2	DHT 96-2	DHT 96-2	-	-
0.012	123	DHT 96-2	DHT 96-2	DHT 96-2	-	-
0.015	153	DHT 96-2	DHT 96-2	-	-	-
0.018	183	DHT 96-2	DHT 96-2	-	-	-
0.022	223	DHT 96-2	-	-	-	-
0.027	273	DHT 96-2	-	-	-	-
0.033	333	DHT 96-2	-	-	-	-

MICA HIGH VOLTAGE CAPACITORS

TYPE DHT 96

STANDARD RATINGS

Capacitance		3,000 VDC	4,000 VDC	5,000 VDC	7,500 VDC	10,000 VDC
μF	Code					
0.0015	153	DHT 96-3	DHT 96-3	DHT 96-3	DHT 96-3	DHT 96-3
0.0018	183	DHT 96-3	DHT 96-3	DHT 96-3	DHT 96-3	DHT 96-3
0.002	203	DHT 96-3	DHT 96-3	DHT 96-3	DHT 96-3	DHT 96-3
0.0022	223	DHT 96-3	DHT 96-3	DHT 96-3	DHT 96-3	DHT 96-3
0.0027	273	DHT 96-3	DHT 96-3	DHT 96-3	DHT 96-3	DHT 96-3
0.0033	333	DHT 96-3	DHT 96-3	DHT 96-3	DHT 96-3	DHT 96-3
0.0039	393	DHT 96-3	DHT 96-3	DHT 96-3	DHT 96-3	DHT 96-3
0.0047	273	DHT 96-3	DHT 96-3	DHT 96-3	DHT 96-3	DHT 96-3
0.0056	563	DHT 96-3	DHT 96-3	DHT 96-3	DHT 96-3	-
0.0068	683	DHT 96-3	DHT 96-3	DHT 96-3	DHT 96-3	-
0.0082	823	DHT 96-3	DHT 96-3	DHT 96-3	DHT 96-3	-
0.01	104	DHT 96-3	DHT 96-3	DHT 96-3	DHT 96-3	-
0.012	124	DHT 96-3	DHT 96-3	DHT 96-3	-	-
0.015	154	DHT 96-3	DHT 96-3	DHT 96-3	-	-
0.018	184	DHT 96-3	DHT 96-3	DHT 96-3	-	-
0.02	204	DHT 96-3	DHT 96-3	DHT 96-3	-	-
0.022	224	DHT 96-3	DHT 96-3	DHT 96-3	-	-
0.027	274	DHT 96-3	DHT 96-3	-	-	-
0.033	334	DHT 96-3	DHT 96-3	-	-	-
0.039	394	DHT 96-3	-	-	-	-
0.047	474	DHT 96-3	-	-	-	-
0.05	504	DHT 96-3	-	-	-	-
0.056	564	DHT 96-3	-	-	-	-
0.0018	182	DHT 96-4	DHT 96-4	DHT 96-4	DHT 96-4	DHT 96-4
0.002	202	DHT 96-4	DHT 96-4	DHT 96-4	DHT 96-4	DHT 96-4
0.0022	222	DHT 96-4	DHT 96-4	DHT 96-4	DHT 96-4	DHT 96-4
0.0027	272	DHT 96-4	DHT 96-4	DHT 96-4	DHT 96-4	DHT 96-4
0.0033	332	DHT 96-4	DHT 96-4	DHT 96-4	DHT 96-4	DHT 96-4
0.0039	392	DHT 96-4	DHT 96-4	DHT 96-4	DHT 96-4	DHT 96-4
0.0047	472	DHT 96-4	DHT 96-4	DHT 96-4	DHT 96-4	DHT 96-4
0.005	502	DHT 96-4	DHT 96-4	DHT 96-4	DHT 96-4	DHT 96-4
0.0056	562	DHT 96-4	DHT 96-4	DHT 96-4	DHT 96-4	DHT 96-4
0.0068	682	DHT 96-4	DHT 96-4	DHT 96-4	DHT 96-4	DHT 96-4
0.0082	822	DHT 96-4	DHT 96-4	DHT 96-4	DHT 96-4	-
0.01	103	DHT 96-4	DHT 96-4	DHT 96-4	DHT 96-4	-
0.012	123	DHT 96-4	DHT 96-4	DHT 96-4	DHT 96-4	-
0.015	153	DHT 96-4	DHT 96-4	DHT 96-4	DHT 96-4	-
0.018	183	DHT 96-4	DHT 96-4	DHT 96-4	-	-
0.02	203	DHT 96-4	DHT 96-4	DHT 96-4	-	-
0.022	223	DHT 96-4	DHT 96-4	DHT 96-4	-	-
0.027	273	DHT 96-4	DHT 96-4	DHT 96-4	-	-
0.033	333	DHT 96-4	DHT 96-4	DHT 96-4	-	-
0.039	393	DHT 96-4	DHT 96-4	-	-	-
0.047	473	DHT 96-4	DHT 96-4	-	-	-
0.056	563	DHT 96-4	-	-	-	-
0.068	683	DHT 96-4	-	-	-	-
0.082	823	DHT 96-4	-	-	-	-

MICA HIGH VOLTAGE CAPACITORS

STANDARD RATINGS

Capacitance		3,000 VDC	4,000 VDC	5,000 VDC	7,500 VDC	10,000 VDC
μF	Code					
0.0018	182	DHT 96-5	DHT 96-5	DHT 96-5	DHT 96-5	DHT 96-5
0.002	202	DHT 96-5	DHT 96-5	DHT 96-5	DHT 96-5	DHT 96-5
0.0022	222	DHT 96-5	DHT 96-5	DHT 96-5	DHT 96-5	DHT 96-5
0.0027	272	DHT 96-5	DHT 96-5	DHT 96-5	DHT 96-5	DHT 96-5
0.0033	332	DHT 96-5	DHT 96-5	DHT 96-5	DHT 96-5	DHT 96-5
0.0039	392	DHT 96-5	DHT 96-5	DHT 96-5	DHT 96-5	DHT 96-5
0.0047	472	DHT 96-5	DHT 96-5	DHT 96-5	DHT 96-5	DHT 96-5
0.01	103	DHT 96-5	DHT 96-5	DHT 96-5	DHT 96-5	DHT 96-5
0.012	123	DHT 96-5	DHT 96-5	DHT 96-5	DHT 96-5	DHT 96-5
0.015	153	DHT 96-5	DHT 96-5	DHT 96-5	DHT 96-5	DHT 96-5
0.018	183	DHT 96-5	DHT 96-5	DHT 96-5	DHT 96-5	
0.02	203	DHT 96-5	DHT 96-5	DHT 96-5	DHT 96-5	-
0.022	223	DHT 96-5	DHT 96-5	DHT 96-5	DHT 96-5	-
0.027	273	DHT 96-5	DHT 96-5	DHT 96-5	DHT 96-5	-
0.033	333	DHT 96-5	DHT 96-5	DHT 96-5	DHT 96-5	-
0.039	183	DHT 96-5	DHT 96-5	-	-	-
0.047	473	DHT 96-5	DHT 96-5	-	-	-
0.05	503	DHT 96-5	DHT 96-5			
0.056	563	DHT 96-5	DHT 96-5	-	-	-
0.068	683	DHT 96-5	-	-	-	-
0.082	823	DHT 96-5	-	-	-	-
0.0027	272	DHT 96-6	DHT 96-6	DHT 96-6	DHT 96-6	DHT 96-6
0.0033	332	DHT 96-6	DHT 96-6	DHT 96-6	DHT 96-6	DHT 96-6
0.0039	392	DHT 96-6	DHT 96-6	DHT 96-6	DHT 96-6	DHT 96-6
0.0047	472	DHT 96-6	DHT 96-6	DHT 96-6	DHT 96-6	DHT 96-6
0.005	502	DHT 96-6	DHT 96-6	DHT 96-6	DHT 96-6	DHT 96-6
0.0056	562	DHT 96-6	DHT 96-6	DHT 96-6	DHT 96-6	DHT 96-6
0.0068	682	DHT 96-6	DHT 96-6	DHT 96-6	DHT 96-6	DHT 96-6
0.0082	822	DHT 96-6	DHT 96-6	DHT 96-6	DHT 96-6	DHT 96-6
0.01	103	DHT 96-6	DHT 96-6	DHT 96-6	DHT 96-6	DHT 96-6
0.012	123	DHT 96-6	DHT 96-6	DHT 96-6	DHT 96-6	DHT 96-6
0.015	153	DHT 96-6	DHT 96-6	DHT 96-6	DHT 96-6	-
0.018	183	DHT 96-6	DHT 96-6	DHT 96-6	DHT 96-6	-
0.02	203	DHT 96-6	DHT 96-6	DHT 96-6	DHT 96-6	-
0.022	223	DHT 96-6	DHT 96-6	DHT 96-6	DHT 96-6	-
0.027	273	DHT 96-6	DHT 96-6	DHT 96-6	-	-
0.033	333	DHT 96-6	DHT 96-6	DHT 96-6	-	-
0.039	393	DHT 96-6	DHT 96-6	DHT 96-6	-	-
0.05	503	DHT 96-6	DHT 96-6	DHT 96-6		
0.056	563	DHT 96-6	DHT 96-6	DHT 96-6	-	-
0.068	683	DHT 96-6	DHT 96-6	-	-	-
0.082	823	DHT 96-6	DHT 96-6	-	-	-
0.1	104	DHT 96-6	-	-	-	-
0.12	124	DHT 96-6	-	-	-	-



PHYSICAL CHARACTERISTICS

CONSTRUCTION:

Metal foils, non-inductive.

CASE:

- Dielectric: composite reconstituted mica
- Epoxy resin sealed
- Radial leads
- Epoxy resin impregnated
- Polyester wrapped

MARKING:

Dearborn trademark, type or catalog number, capacitance, tolerance and voltage.

ELECTRICAL SPECIFICATIONS

OPERATING TEMPERATURE RANGE:

-55°C to +125°C

DISSIPATION FACTOR:

$\leq 0.7\%$ @ 1kHz for $C_R \leq 1.5\text{nF}$

$\leq 0.5\%$ @ 1kHz for $C_R > 1.5\text{nF}$

INSULATION RESISTANCE (IR):

$\geq 25,000\text{ M}\Omega$ for $C_R \leq 0.22\text{ }\mu\text{F}$

$\geq 5,000\text{ M}\Omega\cdot\mu\text{F}$ for $C_R > 0.22\text{ }\mu\text{F}$

DIELECTRIC WITHSTANDING VOLTAGE (DWV):

1.4 x rated voltage

CAPACITANCE TOLERANCES AVAILABLE:

$\pm 20\%$ and $\pm 10\%$

DIMENSIONS (in inches)

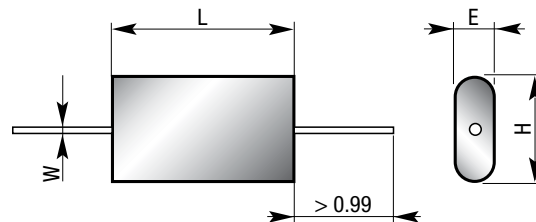

MICA HIGH VOLTAGE CAPACITORS

STANDARD RATINGS

Capacitance		Dimensions (in inches)				TYPE DHT 97									
µF	Code	Max. "L"	Max. "E"	Max. "H"	"W" Gauge	1,500 V	2,500 V	3,500 V	5,000 V	7,500 V	10,000 V	12,500 V	15,000 V	20,000 V	
0.0033	332	1.063	0.197	0.551	18	DHT 97	DHT 97	DHT 97	DHT 97	-	-	-	-	-	
0.0068	682	1.063	0.197	0.551	18	DHT 97	DHT 97	DHT 97	-	-	-	-	-	-	
0.015	153	1.063	0.197	0.551	18	DHT 97	DHT 97	-	-	-	-	-	-	-	
0.022	223	1.063	0.197	0.551	18	DHT 97	-	-	-	-	-	-	-	-	
0.001	102	1.457	0.177	0.551	18	DHT 97	DHT 97	DHT 97	DHT 97	DHT 97	DHT 97	DHT 97	-	-	
0.0022	222	1.457	0.177	0.551	18	DHT 97	DHT 97	DHT 97	DHT 97	DHT 97	-	-	-	-	
0.0047	472	1.457	0.177	0.551	18	DHT 97	DHT 97	DHT 97	DHT 97	-	-	-	-	-	
0.01	103	1.457	0.177	0.551	18	DHT 97	DHT 97	DHT 97	-	-	-	-	-	-	
0.022	223	1.457	0.177	0.551	18	DHT 97	DHT 97	-	-	-	-	-	-	-	
0.033	333	1.457	0.177	0.551	18	DHT 97	-	-	-	-	-	-	-	-	
0.0015	152	1.457	0.177	0.551	18	DHT 97	DHT 97	DHT 97	DHT 97	DHT 97	DHT 97	-	-	-	
0.0033	332	1.457	0.177	0.551	18	DHT 97	DHT 97	DHT 97	DHT 97	DHT 97	-	-	-	-	
0.0068	682	1.457	0.177	0.551	18	DHT 97	DHT 97	DHT 97	DHT 97	-	-	-	-	-	
0.015	153	1.457	0.177	0.551	18	DHT 97	DHT 97	DHT 97	-	-	-	-	-	-	
0.033	333	1.457	0.177	0.551	18	DHT 97	DHT 97	-	-	-	-	-	-	-	
0.047	473	1.457	0.177	0.551	18	DHT 97	-	-	-	-	-	-	-	-	
0.001	102	1.475	0.276	0.551	18	DHT 97	DHT 97	DHT 97	DHT 97	DHT 97	DHT 97	DHT 97	DHT 97	-	
0.0015	152	1.457	0.276	0.551	18	DHT 97	DHT 97	DHT 97	DHT 97	DHT 97	DHT 97	DHT 97	-	-	
0.0022	222	1.457	0.276	0.551	18	DHT 97	DHT 97	DHT 97	DHT 97	DHT 97	DHT 97	-	-	-	
0.0047	472	1.457	0.276	0.551	18	DHT 97	DHT 97	DHT 97	DHT 97	DHT 97	DHT 97	-	-	-	
0.01	103	1.457	0.276	0.551	18	DHT 97	DHT 97	DHT 97	DHT 97	-	-	-	-	-	
0.022	223	1.457	0.276	0.551	18	DHT 97	DHT 97	DHT 97	-	-	-	-	-	-	
0.047	473	1.457	0.276	0.551	18	DHT 97	DHT 97	-	-	-	-	-	-	-	
0.068	683	1.457	0.276	0.551	18	DHT 97	-	-	-	-	-	-	-	-	
0.0015	152	1.457	0.276	0.709	18	DHT 97	DHT 97	DHT 97	DHT 97	DHT 97	DHT 97	DHT 97	DHT 97	-	
0.0022	222	1.457	0.276	0.709	18	DHT 97	DHT 97	DHT 97	DHT 97	DHT 97	DHT 97	DHT 97	-	-	
0.0033	332	1.457	0.276	0.709	18	DHT 97	DHT 97	DHT 97	DHT 97	DHT 97	DHT 97	-	-	-	
0.0068	682	1.457	0.276	0.709	18	DHT 97	DHT 97	DHT 97	DHT 97	DHT 97	-	-	-	-	
0.015	153	1.457	0.276	0.709	18	DHT 97	DHT 97	DHT 97	DHT 97	-	-	-	-	-	
0.033	333	1.457	0.276	0.709	18	DHT 97	DHT 97	DHT 97	-	-	-	-	-	-	
0.068	683	1.457	0.276	0.709	18	DHT 97	DHT 97	-	-	-	-	-	-	-	
0.1	104	1.457	0.276	0.709	18	DHT 97	-	-	-	-	-	-	-	-	
0.0022	222	1.457	0.276	1.024	18	DHT 97	DHT 97	DHT 97	DHT 97	DHT 97	DHT 97	DHT 97	DHT 97	-	
0.0033	332	1.457	0.276	1.024	18	DHT 97	DHT 97	DHT 97	DHT 97	DHT 97	DHT 97	DHT 97	-	-	
0.0047	472	1.457	0.276	1.024	18	DHT 97	DHT 97	DHT 97	DHT 97	DHT 97	DHT 97	-	-	-	
0.01	103	1.457	0.276	1.024	18	DHT 97	DHT 97	DHT 97	DHT 97	DHT 97	-	-	-	-	
0.022	223	1.457	0.276	1.024	18	DHT 97	DHT 97	DHT 97	DHT 97	-	-	-	-	-	
0.047	473	1.457	0.276	1.024	18	DHT 97	DHT 97	DHT 97	-	-	-	-	-	-	
0.1	104	1.457	0.276	1.024	18	DHT 97	DHT 97	-	-	-	-	-	-	-	
0.15	154	1.457	0.276	1.024	18	DHT 97	-	-	-	-	-	-	-	-	
0.0033	332	1.457	0.355	1.26	18	DHT 97	DHT 97	DHT 97	DHT 97	DHT 97	DHT 97	DHT 97	DHT 97	-	
0.0047	472	1.457	0.355	1.26	18	DHT 97	DHT 97	DHT 97	DHT 97	DHT 97	DHT 97	DHT 97	-	-	
0.0068	682	1.457	0.355	1.26	18	DHT 97	DHT 97	DHT 97	DHT 97	DHT 97	DHT 97	DHT 97	-	-	
0.015	153	1.457	0.355	1.26	18	DHT 97	DHT 97	DHT 97	DHT 97	DHT 97	-	-	-	-	
0.033	333	1.457	0.355	1.26	18	DHT 97	DHT 97	DHT 97	DHT 97	-	-	-	-	-	
0.068	683	1.457	0.355	1.26	18	DHT 97	DHT 97	DHT 97	-	-	-	-	-	-	
0.15	154	1.457	0.355	1.26	18	DHT 97	DHT 97	-	-	-	-	-	-	-	
0.22	224	1.457	0.355	1.26	18	DHT 97	-	-	-	-	-	-	-	-	
0.0047	472	1.457	0.355	1.654	18	DHT 97	DHT 97	DHT 97	DHT 97	DHT 97	DHT 97	DHT 97	DHT 97	-	
0.0068	682	1.457	0.355	1.654	18	DHT 97	DHT 97	DHT 97	DHT 97	DHT 97	DHT 97	DHT 97	-	-	
0.01	103	1.457	0.355	1.654	18	DHT 97	DHT 97	DHT 97	DHT 97	DHT 97	DHT 97	-	-	-	
0.022	223	1.457	0.355	1.654	18	DHT 97	DHT 97	DHT 97	DHT 97	DHT 97	-	-	-	-	
0.047	473	1.457	0.355	1.654	18	DHT 97	DHT 97	DHT 97	DHT 97	-	-	-	-	-	
0.1	104	1.457	0.355	1.654	18	DHT 97	DHT 97	DHT 97	-	-	-	-	-	-	
0.22	224	1.457	0.355	1.654	18	DHT 97	DHT 97	-	-	-	-	-	-	-	
0.33	334	1.457	0.355	1.654	18	DHT 97	-	-	-	-	-	-	-	-	

MICA HIGH VOLTAGE CAPACITORS

TYPE DHT 97 /
DHT 97P⁽¹⁾

STANDARD RATINGS

Capacitance		Dimensions (in inches)				TYPE DHT 97									
μF	Code	Max. "L"	Max. "E"	Max. "H"	"W" Gauge	1,500 V	2,500 V	3,500 V	5,000 V	7,500 V	10,000 V	12,500 V	15,000 V	20,000 V	
0.0001	101	2.48	0.197	0.866	18	-	-	-	-	-	-	-	-	DHT 97	
0.00015	151	2.48	0.197	0.866	18	-	-	-	-	-	-	-	-	DHT 97	
0.00022	221	2.48	0.197	0.866	18	-	-	-	-	-	-	-	-	DHT 97	
0.00033	331	2.48	0.197	0.866	18	-	-	-	-	-	-	-	-	DHT 97	
0.00047	471	2.48	0.197	0.866	18	-	-	-	-	-	-	-	-	DHT 97	
0.00068	681	2.48	0.197	0.866	18	-	-	-	-	-	-	-	-	DHT 97	
0.001	102	2.48	0.197	0.866	18	-	-	-	-	-	-	-	-	DHT 97	
0.0015	152	2.48	0.197	0.866	18	-	-	-	-	-	-	-	-	DHT 97	
0.0022	222	2.48	0.276	0.945	18	-	-	-	-	-	-	-	-	DHT 97	
0.0033	332	2.48	0.355	1.024	18	DHT 97	DHT 97	DHT 97	DHT 97	DHT 97	DHT 97	DHT 97	DHT 97	DHT 97	
0.0068	682	2.48	0.355	1.024	18	DHT 97	DHT 97	DHT 97	DHT 97	DHT 97	DHT 97	DHT 97	DHT 97	-	
0.01	103	2.48	0.355	1.024	18	DHT 97	DHT 97	DHT 97	DHT 97	DHT 97	DHT 97	DHT 97	-	-	
0.015	153	2.48	0.355	1.024	18	DHT 97	DHT 97	DHT 97	DHT 97	DHT 97	DHT 97	-	-	-	
0.033	333	2.48	0.355	1.024	18	DHT 97	DHT 97	DHT 97	DHT 97	DHT 97	-	-	-	-	
0.068	683	2.48	0.355	1.024	18	DHT 97	DHT 97	DHT 97	DHT 97	-	-	-	-	-	
0.15	154	2.48	0.355	1.024	18	DHT 97	DHT 97	DHT 97	-	-	-	-	-	-	
0.0047	472	2.48	0.355	1.26	18	DHT 97	DHT 97	DHT 97	DHT 97	DHT 97	DHT 97	DHT 97	DHT 97	DHT 97	
0.01	103	2.48	0.355	1.26	18	DHT 97	DHT 97	DHT 97	DHT 97	DHT 97	DHT 97	DHT 97	DHT 97	-	
0.015	153	2.48	0.355	1.26	18	DHT 97	DHT 97	DHT 97	DHT 97	DHT 97	DHT 97	DHT 97	-	-	
0.022	223	2.48	0.355	1.26	18	DHT 97	DHT 97	DHT 97	DHT 97	DHT 97	DHT 97	-	-	-	
0.047	473	2.48	0.355	1.26	18	DHT 97	DHT 97	DHT 97	DHT 97	DHT 97	-	-	-	-	
0.1	104	2.48	0.355	1.26	18	DHT 97	DHT 97	DHT 97	DHT 97	-	-	-	-	-	
0.22	224	2.48	0.355	1.26	18	DHT 97	DHT 97	DHT 97	-	-	-	-	-	-	
0.33	334	2.48	0.355	1.26	18	DHT 97	DHT 97	-	-	-	-	-	-	-	
0.47	474	2.48	0.355	1.26	18	DHT 97	-	-	-	-	-	-	-	-	
0.0068	682	2.48	0.355	1.851	18	DHT 97	DHT 97	DHT 97	DHT 97	DHT 97	DHT 97	DHT 97	DHT 97	DHT 97	
0.015	153	2.48	0.355	1.851	18	DHT 97	DHT 97	DHT 97	DHT 97	DHT 97	DHT 97	DHT 97	DHT 97	-	
0.022	223	2.48	0.355	1.851	18	DHT 97	DHT 97	DHT 97	DHT 97	DHT 97	DHT 97	DHT 97	-	-	
0.033	333	2.48	0.355	1.851	18	DHT 97	DHT 97	DHT 97	DHT 97	DHT 97	DHT 97	-	-	-	
0.068	683	2.48	0.355	1.851	18	DHT 97	DHT 97	DHT 97	DHT 97	DHT 97	-	-	-	-	
0.15	154	2.48	0.355	1.851	18	DHT 97	DHT 97	DHT 97	DHT 97	-	-	-	-	-	
0.33	334	2.48	0.355	1.851	18	DHT 97	DHT 97	DHT 97	-	-	-	-	-	-	
0.47	474	2.48	0.355	1.851	18	DHT 97	DHT 97	-	-	-	-	-	-	-	
0.68	684	2.48	0.355	1.851	18	DHT 97	-	-	-	-	-	-	-	-	
0.01	103	3.189	0.355	1.851	16	DHT 97	DHT 97	DHT 97	DHT 97	DHT 97	DHT 97	DHT 97	DHT 97	DHT 97	
0.022	223	3.189	0.355	1.851	16	DHT 97	DHT 97	DHT 97	DHT 97	DHT 97	DHT 97	DHT 97	DHT 97	-	
0.033	333	3.189	0.355	1.851	16	DHT 97	DHT 97	DHT 97	DHT 97	DHT 97	DHT 97	DHT 97	-	-	
0.047	473	3.189	0.355	1.851	16	DHT 97	DHT 97	DHT 97	DHT 97	DHT 97	DHT 97	-	-	-	
0.1	104	3.189	0.355	1.851	16	DHT 97	DHT 97	DHT 97	DHT 97	DHT 97	-	-	-	-	
0.22	224	3.189	0.355	1.851	16	DHT 97	DHT 97	DHT 97	DHT 97	-	-	-	-	-	
0.47	474	3.189	0.355	1.851	16	DHT 97	DHT 97	DHT 97	-	-	-	-	-	-	
0.68	684	3.189	0.355	1.851	16	DHT 97	DHT 97	-	-	-	-	-	-	-	
1	105	3.189	0.355	1.851	16	DHT 97	-	-	-	-	-	-	-	-	
0.015	153	3.189	0.433	1.929	16	DHT 97	DHT 97	DHT 97	DHT 97	DHT 97	DHT 97	DHT 97	DHT 97	DHT 97	
0.033	333	3.189	0.433	1.929	16	DHT 97	DHT 97	DHT 97	DHT 97	DHT 97	DHT 97	DHT 97	DHT 97	-	
0.047	473	3.189	0.433	1.929	16	DHT 97	DHT 97	DHT 97	DHT 97	DHT 97	DHT 97	DHT 97	-	-	
0.068	683	3.189	0.433	1.929	16	DHT 97	DHT 97	DHT 97	DHT 97	DHT 97	DHT 97	-	-	-	
0.15	154	3.189	0.433	1.929	16	DHT 97	DHT 97	DHT 97	DHT 97	DHT 97	-	-	-	-	
0.33	334	3.189	0.433	1.929	16	DHT 97	DHT 97	DHT 97	DHT 97	-	-	-	-	-	
0.68	684	3.189	0.433	1.929	16	DHT 97	DHT 97	DHT 97	-	-	-	-	-	-	
1	105	3.189	0.433	1.929	16	DHT 97	DHT 97	-	-	-	-	-	-	-	
1.5	155	3.189	0.433	1.929	16	DHT 97	-	-	-	-	-	-	-	-	

MICA HIGH VOLTAGE CAPACITORS

STANDARD RATINGS

Capacitance		Dimensions (in inches)				TYPE DHT 97									
µF	Code	Max. "L"	Max. "E"	Max. "H"	"W" Gauge	1,500 V	2,500 V	3,500 V	5,000 V	7,500 V	10,000 V	12,500 V	15,000 V	20,000 V	
0.022	223	4.213	0.433	1.929	16	DHT 97	DHT 97	DHT 97	DHT 97	DHT 97	DHT 97	DHT 97	DHT 97	DHT 97	
0.047	473	4.213	0.433	1.929	16	DHT 97	DHT 97	DHT 97	DHT 97	DHT 97	DHT 97	DHT 97	DHT 97	-	
0.068	683	4.213	0.433	1.929	16	DHT 97	DHT 97	DHT 97	DHT 97	DHT 97	DHT 97	DHT 97	-	-	
0.1	104	4.213	0.433	1.929	16	DHT 97	DHT 97	DHT 97	DHT 97	DHT 97	DHT 97	-	-	-	
0.22	224	4.213	0.433	1.929	16	DHT 97	DHT 97	DHT 97	DHT 97	DHT 97	-	-	-	-	
0.47	474	4.213	0.433	1.929	16	DHT 97	DHT 97	DHT 97	DHT 97	-	-	-	-	-	
1	105	4.213	0.433	1.929	16	DHT 97	DHT 97	DHT 97	-	-	-	-	-	-	
1.5	155	4.213	0.433	1.929	16	DHT 97	DHT 97	-	-	-	-	-	-	-	
2.2	225	4.213	0.433	1.929	16	DHT 97	-	-	-	-	-	-	-	-	
0.033	333	4.213	0.63	2.047	16	DHT 97	DHT 97	DHT 97	DHT 97	DHT 97	DHT 97	DHT 97	DHT 97	DHT 97	
0.068	68	4.213	0.63	2.047	16	DHT 97	DHT 97	DHT 97	DHT 97	DHT 97	DHT 97	DHT 97	DHT 97	-	
0.1	104	4.213	0.63	2.047	16	DHT 97	DHT 97	DHT 97	DHT 97	DHT 97	DHT 97	DHT 97	-	-	
0.15	154	4.213	0.63	2.047	16	DHT 97	DHT 97	DHT 97	DHT 97	DHT 97	DHT 97	-	-	-	
0.33	334	4.213	0.63	2.047	16	DHT 97	DHT 97	DHT 97	DHT 97	DHT 97	-	-	-	-	
0.68	684	4.213	0.63	2.047	16	DHT 97	DHT 97	DHT 97	DHT 97	-	-	-	-	-	
1.5	155	4.213	0.63	2.047	16	DHT 97	DHT 97	DHT 97	-	-	-	-	-	-	

STANDARD RATINGS

Capacitance		Dimensions (in inches)				TYPE DHT 97P(1)									
µF	Code	Max. "L"	Max. "E"	Max. "H"	"W" Gauge	1,500 V	2,500 V	3,500 V	5,000 V	7,500 V	10,000 V	12,500 V	15,000 V	20,000 V	
0.0033	332	1.024	0.197	0.512	18	DHT 97P(1)	DHT 97P(1)	DHT 97P(1)	DHT 97P(1)	-	-	-	-	-	
0.0068	682	1.024	0.197	0.512	18	DHT 97P(1)	DHT 97P(1)	DHT 97P(1)	-	-	-	-	-	-	
0.015	153	1.024	0.197	0.512	18	DHT 97P(1)	DHT 97P(1)	-	-	-	-	-	-	-	
0.022	223	1.024	0.197	0.512	18	DHT 97P(1)	-	-	-	-	-	-	-	-	
0.001	102	1.418	0.177	0.512	18	DHT 97P(1)	DHT 97P(1)	DHT 97P(1)	DHT 97P(1)	DHT 97P(1)	DHT 97P(1)	DHT 97P(1)	-	-	
0.0022	222	1.418	0.177	0.512	18	DHT 97P(1)	DHT 97P(1)	DHT 97P(1)	DHT 97P(1)	DHT 97P(1)	-	-	-	-	
0.0047	472	1.418	0.177	0.512	18	DHT 97P(1)	DHT 97P(1)	DHT 97P(1)	DHT 97P(1)	-	-	-	-	-	
0.01	103	1.418	0.177	0.512	18	DHT 97P(1)	DHT 97P(1)	DHT 97P(1)	-	-	-	-	-	-	
0.022	223	1.418	0.177	0.512	18	DHT 97P(1)	DHT 97P(1)	-	-	-	-	-	-	-	
0.033	333	1.418	0.177	0.512	18	DHT 97P(1)	-	-	-	-	-	-	-	-	
0.0015	152	1.418	0.177	0.512	18	DHT 97P(1)	DHT 97P(1)	DHT 97P(1)	DHT 97P(1)	DHT 97P(1)	DHT 97P(1)	-	-	-	
0.0033	332	1.418	0.177	0.512	18	DHT 97P(1)	DHT 97P(1)	DHT 97P(1)	DHT 97P(1)	DHT 97P(1)	-	-	-	-	
0.0068	682	1.418	0.177	0.512	18	DHT 97P(1)	DHT 97P(1)	DHT 97P(1)	DHT 97P(1)	-	-	-	-	-	
0.015	153	1.418	0.177	0.512	18	DHT 97P(1)	DHT 97P(1)	DHT 97P(1)	-	-	-	-	-	-	
0.033	333	1.418	0.177	0.512	18	DHT 97P(1)	DHT 97P(1)	-	-	-	-	-	-	-	
0.047	473	1.418	0.177	0.512	18	DHT 97P(1)	-	-	-	-	-	-	-	-	
0.001	102	1.418	0.276	0.512	18	DHT 97P(1)	DHT 97P(1)	DHT 97P(1)	DHT 97P(1)	DHT 97P(1)	DHT 97P(1)	DHT 97P(1)	DHT 97P(1)	-	
0.0015	152	1.418	0.276	0.512	18	DHT 97P(1)	DHT 97P(1)	DHT 97P(1)	DHT 97P(1)	DHT 97P(1)	DHT 97P(1)	DHT 97P(1)	-	-	
0.0022	222	1.418	0.276	0.512	18	DHT 97P(1)	DHT 97P(1)	DHT 97P(1)	DHT 97P(1)	DHT 97P(1)	DHT 97P(1)	-	-	-	
0.0047	472	1.418	0.276	0.512	18	DHT 97P(1)	DHT 97P(1)	DHT 97P(1)	DHT 97P(1)	DHT 97P(1)	-	-	-	-	
0.01	103	1.418	0.276	0.512	18	DHT 97P(1)	DHT 97P(1)	DHT 97P(1)	DHT 97P(1)	-	-	-	-	-	
0.022	223	1.418	0.276	0.512	18	DHT 97P(1)	DHT 97P(1)	DHT 97P(1)	-	-	-	-	-	-	
0.047	473	1.418	0.276	0.512	18	DHT 97P(1)	DHT 97P(1)	-	-	-	-	-	-	-	
0.068	673	1.418	0.276	0.512	18	DHT 97P(1)	-	-	-	-	-	-	-	-	

Note: P(1) Premolded Capacitor for Dielectric Fluid use or Encapsulation.

MICA HIGH VOLTAGE CAPACITORS

TYPE DHT 97 /
DHT 97P⁽¹⁾

STANDARD RATINGS

Capacitance		Dimensions (in inches)				TYPE DHT 97P ⁽¹⁾									
μF	Code	Max. "L"	Max. "E"	Max. "H"	"W" Gauge	1,500 V	2,500 V	3,500 V	5,000 V	7,500 V	10,000 V	12,500 V	15,000 V	20,000 V	
0.0015	152	1.418	0.276	0.669	18	DHT 97P ⁽¹⁾	DHT 97P ⁽¹⁾	DHT 97P ⁽¹⁾	DHT 97P ⁽¹⁾	DHT 97P ⁽¹⁾	DHT 97P ⁽¹⁾	DHT 97P ⁽¹⁾	DHT 97P ⁽¹⁾	-	
0.0022	222	1.418	0.276	0.669	18	DHT 97P ⁽¹⁾	DHT 97P ⁽¹⁾	DHT 97P ⁽¹⁾	DHT 97P ⁽¹⁾	DHT 97P ⁽¹⁾	DHT 97P ⁽¹⁾	DHT 97P ⁽¹⁾	DHT 97P ⁽¹⁾	-	
0.0033	332	1.418	0.276	0.669	18	DHT 97P ⁽¹⁾	DHT 97P ⁽¹⁾	DHT 97P ⁽¹⁾	DHT 97P ⁽¹⁾	DHT 97P ⁽¹⁾	DHT 97P ⁽¹⁾	DHT 97P ⁽¹⁾	-	-	
0.0068	682	1.418	0.276	0.669	18	DHT 97P ⁽¹⁾	DHT 97P ⁽¹⁾	DHT 97P ⁽¹⁾	DHT 97P ⁽¹⁾	DHT 97P ⁽¹⁾	-	-	-	-	
0.015	153	1.418	0.276	0.669	18	DHT 97P ⁽¹⁾	DHT 97P ⁽¹⁾	DHT 97P ⁽¹⁾	DHT 97P ⁽¹⁾	-	-	-	-	-	
0.033	333	1.418	0.276	0.669	18	DHT 97P ⁽¹⁾	DHT 97P ⁽¹⁾	DHT 97P ⁽¹⁾	-	-	-	-	-	-	
0.068	683	1.418	0.276	0.669	18	DHT 97P ⁽¹⁾	DHT 97P ⁽¹⁾	-	-	-	-	-	-	-	
0.1	104	1.418	0.276	0.669	18	DHT 97P ⁽¹⁾	-	-	-	-	-	-	-	-	
0.0022	222	1.418	0.276	0.984	18	DHT 97P ⁽¹⁾	DHT 97P ⁽¹⁾	DHT 97P ⁽¹⁾	DHT 97P ⁽¹⁾	DHT 97P ⁽¹⁾	DHT 97P ⁽¹⁾	DHT 97P ⁽¹⁾	DHT 97P ⁽¹⁾	-	
0.0033	332	1.418	0.276	0.984	18	DHT 97P ⁽¹⁾	DHT 97P ⁽¹⁾	DHT 97P ⁽¹⁾	DHT 97P ⁽¹⁾	DHT 97P ⁽¹⁾	DHT 97P ⁽¹⁾	DHT 97P ⁽¹⁾	-	-	
0.0047	472	1.418	0.276	0.984	18	DHT 97P ⁽¹⁾	DHT 97P ⁽¹⁾	DHT 97P ⁽¹⁾	DHT 97P ⁽¹⁾	DHT 97P ⁽¹⁾	DHT 97P ⁽¹⁾	-	-	-	
0.01	103	1.418	0.276	0.984	18	DHT 97P ⁽¹⁾	DHT 97P ⁽¹⁾	DHT 97P ⁽¹⁾	DHT 97P ⁽¹⁾	DHT 97P ⁽¹⁾	-	-	-	-	
0.022	223	1.418	0.276	0.984	18	DHT 97P ⁽¹⁾	DHT 97P ⁽¹⁾	DHT 97P ⁽¹⁾	DHT 97P ⁽¹⁾	-	-	-	-	-	
0.047	473	1.418	0.276	0.984	18	DHT 97P ⁽¹⁾	DHT 97P ⁽¹⁾	DHT 97P ⁽¹⁾	-	-	-	-	-	-	
0.1	104	1.418	0.276	0.984	18	DHT 97P ⁽¹⁾	DHT 97P ⁽¹⁾	-	-	-	-	-	-	-	
0.15	155	1.418	0.276	0.984	18	DHT 97P ⁽¹⁾	-	-	-	-	-	-	-	-	
0.0033	332	1.418	0.355	1.22	18	DHT 97P ⁽¹⁾	DHT 97P ⁽¹⁾	DHT 97P ⁽¹⁾	DHT 97P ⁽¹⁾	DHT 97P ⁽¹⁾	DHT 97P ⁽¹⁾	DHT 97P ⁽¹⁾	DHT 97P ⁽¹⁾	-	
0.0047	472	1.418	0.355	1.22	18	DHT 97P ⁽¹⁾	DHT 97P ⁽¹⁾	DHT 97P ⁽¹⁾	DHT 97P ⁽¹⁾	DHT 97P ⁽¹⁾	DHT 97P ⁽¹⁾	DHT 97P ⁽¹⁾	-	-	
0.0068	682	1.418	0.355	1.22	18	DHT 97P ⁽¹⁾	DHT 97P ⁽¹⁾	DHT 97P ⁽¹⁾	DHT 97P ⁽¹⁾	DHT 97P ⁽¹⁾	DHT 97P ⁽¹⁾	-	-	-	
0.015	153	1.418	0.355	1.22	18	DHT 97P ⁽¹⁾	DHT 97P ⁽¹⁾	DHT 97P ⁽¹⁾	DHT 97P ⁽¹⁾	DHT 97P ⁽¹⁾	-	-	-	-	
0.033	333	1.418	0.355	1.22	18	DHT 97P ⁽¹⁾	DHT 97P ⁽¹⁾	DHT 97P ⁽¹⁾	DHT 97P ⁽¹⁾	-	-	-	-	-	
0.068	683	1.418	0.355	1.22	18	DHT 97P ⁽¹⁾	DHT 97P ⁽¹⁾	DHT 97P ⁽¹⁾	-	-	-	-	-	-	
0.15	154	1.418	0.355	1.22	18	DHT 97P ⁽¹⁾	DHT 97P ⁽¹⁾	-	-	-	-	-	-	-	
0.22	224	1.418	0.355	1.22	18	DHT 97P ⁽¹⁾	-	-	-	-	-	-	-	-	
0.0047	472	1.418	0.355	1.614	18	DHT 97P ⁽¹⁾	DHT 97P ⁽¹⁾	DHT 97P ⁽¹⁾	DHT 97P ⁽¹⁾	DHT 97P ⁽¹⁾	DHT 97P ⁽¹⁾	DHT 97P ⁽¹⁾	DHT 97P ⁽¹⁾	-	
0.0068	682	1.418	0.355	1.641	18	DHT 97P ⁽¹⁾	DHT 97P ⁽¹⁾	DHT 97P ⁽¹⁾	DHT 97P ⁽¹⁾	DHT 97P ⁽¹⁾	DHT 97P ⁽¹⁾	DHT 97P ⁽¹⁾	-	-	
0.01	103	1.418	0.355	1.614	18	DHT 97P ⁽¹⁾	DHT 97P ⁽¹⁾	DHT 97P ⁽¹⁾	DHT 97P ⁽¹⁾	DHT 97P ⁽¹⁾	DHT 97P ⁽¹⁾	-	-	-	
0.022	223	1.418	0.355	1.614	18	DHT 97P ⁽¹⁾	DHT 97P ⁽¹⁾	DHT 97P ⁽¹⁾	DHT 97P ⁽¹⁾	DHT 97P ⁽¹⁾	-	-	-	-	
0.047	473	1.418	0.355	1.614	18	DHT 97P ⁽¹⁾	DHT 97P ⁽¹⁾	DHT 97P ⁽¹⁾	DHT 97P ⁽¹⁾	-	-	-	-	-	
0.1	104	1.418	0.355	1.614	18	DHT 97P ⁽¹⁾	DHT 97P ⁽¹⁾	DHT 97P ⁽¹⁾	-	-	-	-	-	-	
0.22	224	1.418	0.355	1.614	18	DHT 97P ⁽¹⁾	DHT 97P ⁽¹⁾	-	-	-	-	-	-	-	
0.33	334	1.418	0.355	1.614	18	DHT 97P ⁽¹⁾	-	-	-	-	-	-	-	-	
0.0001	101	2.441	0.197	0.827	18	-	-	-	-	-	-	-	-	DHT 97P ⁽¹⁾	
0.00015	151	2.441	0.197	0.827	18	-	-	-	-	-	-	-	-	DHT 97P ⁽¹⁾	
0.00022	221	2.441	0.197	0.827	18	-	-	-	-	-	-	-	-	DHT 97P ⁽¹⁾	
0.00033	331	2.441	0.197	0.827	18	-	-	-	-	-	-	-	-	DHT 97P ⁽¹⁾	
0.00047	471	2.441	0.197	0.827	18	-	-	-	-	-	-	-	-	DHT 97P ⁽¹⁾	
0.00068	681	2.441	0.197	0.827	18	-	-	-	-	-	-	-	-	DHT 97P ⁽¹⁾	
0.001	102	2.441	0.197	0.827	18	-	-	-	-	-	-	-	-	DHT 97P ⁽¹⁾	
0.0015	152	2.441	0.197	0.827	18	-	-	-	-	-	-	-	-	DHT 97P ⁽¹⁾	
0.0022	222	2.441	0.276	0.906	18	DHT 97P ⁽¹⁾	DHT 97P ⁽¹⁾	DHT 97P ⁽¹⁾	DHT 97P ⁽¹⁾	DHT 97P ⁽¹⁾	DHT 97P ⁽¹⁾	DHT 97P ⁽¹⁾	DHT 97P ⁽¹⁾	DHT 97P ⁽¹⁾	
0.0033	332	2.441	0.355	0.984	18	DHT 97P ⁽¹⁾	DHT 97P ⁽¹⁾	DHT 97P ⁽¹⁾	DHT 97P ⁽¹⁾	DHT 97P ⁽¹⁾	DHT 97P ⁽¹⁾	DHT 97P ⁽¹⁾	DHT 97P ⁽¹⁾	DHT 97P ⁽¹⁾	
0.0068	682	2.441	0.355	0.984	18	DHT 97P ⁽¹⁾	DHT 97P ⁽¹⁾	DHT 97P ⁽¹⁾	DHT 97P ⁽¹⁾	DHT 97P ⁽¹⁾	DHT 97P ⁽¹⁾	DHT 97P ⁽¹⁾	DHT 97P ⁽¹⁾	-	
0.01	103	2.441	0.355	0.984	18	DHT 97P ⁽¹⁾	DHT 97P ⁽¹⁾	DHT 97P ⁽¹⁾	DHT 97P ⁽¹⁾	DHT 97P ⁽¹⁾	DHT 97P ⁽¹⁾	DHT 97P ⁽¹⁾	-	-	
0.015	153	2.441	0.355	0.984	18	DHT 97P ⁽¹⁾	DHT 97P ⁽¹⁾	DHT 97P ⁽¹⁾	DHT 97P ⁽¹⁾	DHT 97P ⁽¹⁾	DHT 97P ⁽¹⁾	-	-	-	
0.033	333	2.441	0.355	0.984	18	DHT 97P ⁽¹⁾	DHT 97P ⁽¹⁾	DHT 97P ⁽¹⁾	DHT 97P ⁽¹⁾	DHT 97P ⁽¹⁾	-	-	-	-	
0.068	683	2.441	0.355	0.984	18	DHT 97P ⁽¹⁾	DHT 97P ⁽¹⁾	DHT 97P ⁽¹⁾	DHT 97P ⁽¹⁾	-	-	-	-	-	
0.15	154	2.441	0.355	0.984	18	DHT 97P ⁽¹⁾	DHT 97P ⁽¹⁾	DHT 97P ⁽¹⁾	-	-	-	-	-	-	

Note: P(1) Premolded Capacitor for Dielectric Fluid use or Encapsulation.

MICA HIGH VOLTAGE CAPACITORS

STANDARD RATINGS

Capacitance		Dimensions (in inches)				TYPE DHT 97P(1)									
µF	Code	Max. "L"	Max. "E"	Max. "H"	"W" Gauge	1,500 V	2,500 V	3,500 V	5,000 V	7,500 V	10,000 V	12,500 V	15,000 V	20,000 V	
0.0047	472	2.441	0.355	1.22	18	DHT 97P(1)	DHT 97P(1)	DHT 97P(1)	DHT 97P(1)	DHT 97P(1)	DHT 97P(1)	DHT 97P(1)	DHT 97P(1)	DHT 97P(1)	
0.01	103	2.441	0.355	1.22	18	DHT 97P(1)	DHT 97P(1)	DHT 97P(1)	DHT 97P(1)	DHT 97P(1)	DHT 97P(1)	DHT 97P(1)	DHT 97P(1)	-	
0.015	153	2.441	0.355	1.22	18	DHT 97P(1)	DHT 97P(1)	DHT 97P(1)	DHT 97P(1)	DHT 97P(1)	DHT 97P(1)	DHT 97P(1)	DHT 97P(1)	-	
0.022	223	2.441	0.355	1.22	18	DHT 97P(1)	DHT 97P(1)	DHT 97P(1)	DHT 97P(1)	DHT 97P(1)	DHT 97P(1)	-	-	-	
0.047	473	2.441	0.355	1.22	18	DHT 97P(1)	DHT 97P(1)	DHT 97P(1)	DHT 97P(1)	DHT 97P(1)	-	-	-	-	
0.1	104	2.441	0.355	1.22	18	DHT 97P(1)	DHT 97P(1)	DHT 97P(1)	DHT 97P(1)	-	-	-	-	-	
0.22	224	2.441	0.355	1.22	18	DHT 97P(1)	DHT 97P(1)	DHT 97P(1)	-	-	-	-	-	-	
0.33	334	2.441	0.355	1.22	18	DHT 97P(1)	DHT 97P(1)	-	-	-	-	-	-	-	
0.47	474	2.441	0.355	1.22	18	DHT 97P(1)	-	-	-	-	-	-	-	-	
0.0068	682	2.441	0.355	1.811	18	DHT 97P(1)	DHT 97P(1)	DHT 97P(1)	DHT 97P(1)	DHT 97P(1)	DHT 97P(1)	DHT 97P(1)	DHT 97P(1)	DHT 97P(1)	
0.015	153	2.441	0.355	1.811	18	DHT 97P(1)	DHT 97P(1)	DHT 97P(1)	DHT 97P(1)	DHT 97P(1)	DHT 97P(1)	DHT 97P(1)	DHT 97P(1)	-	
0.022	223	2.441	0.355	1.811	18	DHT 97P(1)	DHT 97P(1)	DHT 97P(1)	DHT 97P(1)	DHT 97P(1)	DHT 97P(1)	DHT 97P(1)	-	-	
0.033	333	2.441	0.355	1.811	18	DHT 97P(1)	DHT 97P(1)	DHT 97P(1)	DHT 97P(1)	DHT 97P(1)	DHT 97P(1)	-	-	-	
0.068	683	2.441	0.355	1.811	18	DHT 97P(1)	DHT 97P(1)	DHT 97P(1)	DHT 97P(1)	DHT 97P(1)	-	-	-	-	
0.15	154	2.441	0.355	1.811	18	DHT 97P(1)	DHT 97P(1)	DHT 97P(1)	DHT 97P(1)	-	-	-	-	-	
0.33	334	2.441	0.355	1.811	18	DHT 97P(1)	DHT 97P(1)	DHT 97P(1)	-	-	-	-	-	-	
0.47	474	2.441	0.355	1.811	18	DHT 97P(1)	DHT 97P(1)	-	-	-	-	-	-	-	
0.68	684	2.441	0.355	1.811	18	DHT 97P(1)	-	-	-	-	-	-	-	-	
0.01	103	3.15	0.355	1.811	16	DHT 97P(1)	DHT 97P(1)	DHT 97P(1)	DHT 97P(1)	DHT 97P(1)	DHT 97P(1)	DHT 97P(1)	DHT 97P(1)	DHT 97P(1)	
0.022	223	3.15	0.355	1.811	16	DHT 97P(1)	DHT 97P(1)	DHT 97P(1)	DHT 97P(1)	DHT 97P(1)	DHT 97P(1)	DHT 97P(1)	DHT 97P(1)	-	
0.033	333	3.15	0.355	1.811	16	DHT 97P(1)	DHT 97P(1)	DHT 97P(1)	DHT 97P(1)	DHT 97P(1)	DHT 97P(1)	DHT 97P(1)	-	-	
0.047	473	3.15	0.355	1.811	16	DHT 97P(1)	DHT 97P(1)	DHT 97P(1)	DHT 97P(1)	DHT 97P(1)	DHT 97P(1)	-	-	-	
0.1	104	3.15	0.355	1.811	16	DHT 97P(1)	DHT 97P(1)	DHT 97P(1)	DHT 97P(1)	DHT 97P(1)	-	-	-	-	
0.22	224	3.15	0.355	1.811	16	DHT 97P(1)	DHT 97P(1)	DHT 97P(1)	DHT 97P(1)	-	-	-	-	-	
0.47	474	3.15	0.355	1.811	16	DHT 97P(1)	DHT 97P(1)	DHT 97P(1)	-	-	-	-	-	-	
0.68	684	3.15	0.355	1.811	16	DHT 97P(1)	DHT 97P(1)	-	-	-	-	-	-	-	
1	105	3.15	0.355	1.811	16	DHT 97P(1)	-	-	-	-	-	-	-	-	
0.015	153	3.15	0.433	1.89	16	DHT 97P(1)	DHT 97P(1)	DHT 97P(1)	DHT 97P(1)	DHT 97P(1)	DHT 97P(1)	DHT 97P(1)	DHT 97P(1)	DHT 97P(1)	
0.033	333	3.15	0.433	1.89	16	DHT 97P(1)	DHT 97P(1)	DHT 97P(1)	DHT 97P(1)	DHT 97P(1)	DHT 97P(1)	DHT 97P(1)	DHT 97P(1)	-	
0.047	473	3.15	0.433	1.89	16	DHT 97P(1)	DHT 97P(1)	DHT 97P(1)	DHT 97P(1)	DHT 97P(1)	DHT 97P(1)	DHT 97P(1)	-	-	
0.068	683	3.15	0.433	1.89	16	DHT 97P(1)	DHT 97P(1)	DHT 97P(1)	DHT 97P(1)	DHT 97P(1)	DHT 97P(1)	-	-	-	
0.15	154	3.15	0.433	1.89	16	DHT 97P(1)	DHT 97P(1)	DHT 97P(1)	DHT 97P(1)	DHT 97P(1)	-	-	-	-	
0.33	334	3.15	0.433	1.89	16	DHT 97P(1)	DHT 97P(1)	DHT 97P(1)	DHT 97P(1)	-	-	-	-	-	
0.68	684	3.15	0.433	1.89	16	DHT 97P(1)	DHT 97P(1)	DHT 97P(1)	-	-	-	-	-	-	
1	105	3.15	0.433	1.89	16	DHT 97P(1)	DHT 97P(1)	-	-	-	-	-	-	-	
1.5	155	3.15	0.433	1.89	16	DHT 97P(1)	-	-	-	-	-	-	-	-	
0.022	223	4.173	0.433	1.89	16	DHT 97P(1)	DHT 97P(1)	DHT 97P(1)	DHT 97P(1)	DHT 97P(1)	DHT 97P(1)	DHT 97P(1)	DHT 97P(1)	DHT 97P(1)	
0.047	473	4.173	0.433	1.89	16	DHT 97P(1)	DHT 97P(1)	DHT 97P(1)	DHT 97P(1)	DHT 97P(1)	DHT 97P(1)	DHT 97P(1)	DHT 97P(1)	-	
0.068	683	4.173	0.433	1.89	16	DHT 97P(1)	DHT 97P(1)	DHT 97P(1)	DHT 97P(1)	DHT 97P(1)	DHT 97P(1)	DHT 97P(1)	-	-	
0.1	104	4.173	0.433	1.89	16	DHT 97P(1)	DHT 97P(1)	DHT 97P(1)	DHT 97P(1)	DHT 97P(1)	DHT 97P(1)	-	-	-	
0.22	224	4.173	0.433	1.89	16	DHT 97P(1)	DHT 97P(1)	DHT 97P(1)	DHT 97P(1)	DHT 97P(1)	-	-	-	-	
0.47	474	4.173	0.433	1.89	16	DHT 97P(1)	DHT 97P(1)	DHT 97P(1)	DHT 97P(1)	-	-	-	-	-	
1	105	4.173	0.433	1.89	16	DHT 97P(1)	DHT 97P(1)	DHT 97P(1)	-	-	-	-	-	-	
1.5	155	4.173	0.433	1.89	16	DHT 97P(1)	DHT 97P(1)	-	-	-	-	-	-	-	
2.2	225	4.173	0.433	1.89	16	DHT 97P(1)	-	-	-	-	-	-	-	-	
0.033	333	4.173	0.591	2.008	16	DHT 97P(1)	DHT 97P(1)	DHT 97P(1)	DHT 97P(1)	DHT 97P(1)	DHT 97P(1)	DHT 97P(1)	DHT 97P(1)	DHT 97P(1)	
0.068	68	4.173	0.591	2.008	16	DHT 97P(1)	DHT 97P(1)	DHT 97P(1)	DHT 97P(1)	DHT 97P(1)	DHT 97P(1)	DHT 97P(1)	DHT 97P(1)	-	
0.1	104	4.173	0.591	2.008	16	DHT 97P(1)	DHT 97P(1)	DHT 97P(1)	DHT 97P(1)	DHT 97P(1)	DHT 97P(1)	DHT 97P(1)	-	-	
0.15	154	4.173	0.591	2.008	16	DHT 97P(1)	DHT 97P(1)	DHT 97P(1)	DHT 97P(1)	DHT 97P(1)	DHT 97P(1)	DHT 97P(1)	-	-	
0.33	334	4.173	0.591	2.008	16	DHT 97P(1)	DHT 97P(1)	DHT 97P(1)	DHT 97P(1)	DHT 97P(1)	-	-	-	-	
0.68	684	4.173	0.591	2.008	16	DHT 97P(1)	DHT 97P(1)	DHT 97P(1)	DHT 97P(1)	-	-	-	-	-	
1.5	155	4.173	0.591	2.008	16	DHT 97P(1)	DHT 97P(1)	DHT 97P(1)	-	-	-	-	-	-	

Note: P(1) Premolded Capacitor for Dielectric Fluid use or Encapsulation.





An Exxelia Company

DEARBORN

ELECTRONICS INC.

1221 North US Highway 17-92
Longwood, Florida 32750

T 407 695-6562 • F 407 695-6889

www.dearbornelectronics.com